

Product Catalogue

RESIDENTIAL, COMMERCIAL & GOLF IRRIGATION | *Built on Innovation®*

VOLUME 39

Hunter®



Table of CONTENTS

● INTRODUCTION

- 4 Reflecting on 40 Years of Innovation
- 6 Education, Tools, and Support for Professionals

● ROTORS

- 14 PGJ
- 16 SRM
- 17 PGP™
- 20 PGP Ultra ◀ NEW
- 21 I-20
- 22 PGP Ultra PRB
- 22 I-20 PRB
- 26 I-25
- 29 I-40
- 32 I-50
- 34 I-80
- 36 I-90
- 38 Swing Joints
- 39 Snaplok™ Combo Kits
- 39 Hunter Check Valves

● ST SYSTEM

- 42 ST-90-B
- 42 High-Flow Swing Joints
- 43 ST-1200-BR
- 44 ST-1600-HS-BR
- 45 ST-1700-V
- 46 STG-900-KIT-B/STG-900 ◀ NEW
- 48 STG-1600-KIT-B/ST-1600-HS-B ◀ NEW

● MP ROTATOR®

- 52 Eco-Rotator
- 54 MP Rotator
- 58 MP Rotator 800
- 60 MP Stake ◀ NEW

● SPRAYS

- 66 PS Ultra
- 69 Pro-Spray™
- 70 PRS30
- 71 PRS40

● SPRAY ACCESSORIES

- 72 SJ Swing Joints
- 72 Hunter Spiral Barb Elbows ◀ NEW
- 72 FlexSG Tubing
- 72 Pro-Spray Shutoff Cap
- 72 Shutoff Nozzle

● NOZZLES

- 74 Pro Adjustable Nozzles
- 78 Pro-Spray Fixed Arc Nozzles
- 81 Short-Radius Micro Spray Nozzles
- 82 Strip Pattern Nozzles
- 83 Stream Nozzles
- 84 Bubbler Nozzles
- 85 Bubblers

● VALVES

- 89 1½" and 2" PGV
- 90 1" PGV and PGV Jar-Top
- 92 ICV
- 94 IBV
- 96 Quick Couplers
- 98 Accu Sync™ Pressure Regulators

● CONTROLLERS

- 102 Controller Selection Guide

● STANDARD CONTROLLERS

- 106 Eco Logic
- 107 X-Core™
- 108 X2™ ◀ NEW
- 109 Pro-C™

● HYDRAWISE® CONTROLLERS

- 112 Hydrawise Software
- 114 HC
- 115 WAND for X2™ ◀ NEW
- 116 Pro-HC
- 117 HPC
- 118 HCC
- 119 Wi-Fi Systems Overview

● CENTRALUS™ CONTROLLERS

- 122 Centralus Software
- 123 ICC2
- 124 ACC2
- 125 ACC2 Decoder

● BATTERY-OPERATED CONTROLLERS

- 128 BTT
- 129 NODE
- 130 NODE-BT
- 131 XC Hybrid

● CONTROLLER DECODERS AND ACCESSORIES

- 134 ICD
- 135 ICD-HP Programmer
- 136 EZ Decoder System
- 137 EZ-DT ◀ NEW
- 138 Universal Decoder Stake ◀ NEW
- 138 Antenna Extension Kits ◀ NEW
- 139 Waterproof Wire Connector ◀ NEW
- 139 Waterproof Splice Kit
- 140 ROAM Remote
- 141 ROAM XL Remote
- 142 Pump Start Relay (PSR)
- 142 Pump Start Relay Booster (PSR-B)
- 143 Controller Communication Devices ◀ NEW

● SENSORS

- 148 Rain-Clik™
- 149 Mini-Clik™
- 150 Soil-Clik™
- 151 Freeze-Clik™
- 151 Wind-Clik™
- 152 Mini-Weather Station (MWS)
- 153 Solar Sync™
- 154 Flow-Sync™
- 155 HC Flow Meter ◀ NEW
- 156 Wireless Flow Sensor (WFS)
- 157 Flow-Clik™

● MICRO

- 160 Soft Pipe System Diagram
- 161 Hard Pipe System Diagram
- 162 PCZ Drip Control Zone Kits
- 163 Filters and Filter Regulators
- 164 Senninger™ Pressure Regulators
- 166 Dripline System Diagram
- 167 HDL-CV
- 168 HDL-PC
- 168 HDL-R
- 169 HDL-COP
- 171 PLD
- 172 16 mm Fittings
- 173 LOC Fittings
- 173 17 mm Barb Fittings
- 174 Subsurface System Diagram
- 175 Eco-Mat™
- 176 Eco-Wrap™
- 177 Supply Tubing
- 177 Eco-Indicator
- 178 MLD
- 179 Distribution Tubing
- 179 6 mm Fittings
- 180 IH Risers
- 181 Point-Source Emitters
- 181 Hunter Emitter Multi-Tool
- 181 Pocket Punch
- 182 Multi-Port Emitters
- 182 Rigid Risers
- 183 Micro Sprays
- 184 Multi-Purpose Box
- 185 Air/Vacuum Relief Valve
- 185 Automatic Flush Valve
- 186 RZWS
- 187 RZWS-E
- 187 RZB

● RECLAIMED

- 190 Rotors/Sprays **◆NEW**
- 191 Bubblers/Valves/Micro

● TOOLS

- 193 SpotShot Hose-End Nozzle
- 193 Pitot Gauge
- 193 MP Gauge Assembly
- 193 Hand Pump
- 193 Nozzle Insertion Collar
- 193 Hunter Wrench
- 193 T-Handle Tool
- 193 Nozzle Removal/Installation Tool
- 193 Snap Ring Tool

● PILOT™ NETWORK

- 195 Pilot Network
- 196 Pilot Command Center Software
- 198 Pilot Field Controller Systems
- 200 Pilot Integrated Hub Systems
- 202 Weather Station
- 203 Maintenance Radio
- 203 ICD-HP Programmer

● GOLF ROTORS

- 208 Golf Rotor Advanced Features
- 212 TTS-800 Series
- 220 G-800 Series
- 228 B Series
- 236 G-900 Series

● GOLF SWING JOINTS AND ACCESSORIES

- 238 Golf Swing Joints
- 238 Acme Adapter Fittings
- 239 Rotor Accessories
- 239 Golf Tools

● TECHNICAL INFORMATION

- 242 Precipitation Rates
- 243 Slope Equivalents/Irrigation
- 244 Height of Spray
- 247 Pilot Electrical Specifications
- 248 Pilot-FC Current Requirement Charts
- 249 Conversion Factors
- 250 Friction Loss Charts
- 257 Pressure Loss Charts
- 257 Accessory Pressure Loss Charts
- 258 BTT Pressure Loss Charts **◆NEW**
- 258 HC Flow Meter
Pressure Loss Chart **◆NEW**
- 259 Wire Data
- 259 PSR Wire Data
- 260 Wire Sizing
- 261 DC-Latching Solenoid
- 261 Additional Data

● STATEMENT OF WARRANTY

- 262 Statement of Warranty

Your Success Is Our Success

REFLECTING ON 40 YEARS OF INNOVATION

This year, we reached an incredible milestone: four decades of leadership in the irrigation industry. We could not have achieved this special anniversary without the support of every one of our customers around the globe.

From the earliest days of our company until now, we have always strived to connect with you through open dialogue and meaningful collaboration.

We listen to your needs. We value your opinions. We overcome obstacles together. Through every shared triumph and challenge, we have kept our focus thanks to mutual trust, flexibility, and respect.

Looking ahead, our commitment to innovation remains as one of our top priorities. In addition to providing you with best-in-class irrigation solutions, we want to be your go-to partner for growing your business. From product training to design tools, our goal is to equip you with the technology, resources, and support you need to work smarter and prepare your business for whatever challenges the future may hold.

Thank you for supporting Hunter Industries. We look forward to finding new ways to strengthen our partnership even more over the next 40 years and beyond.

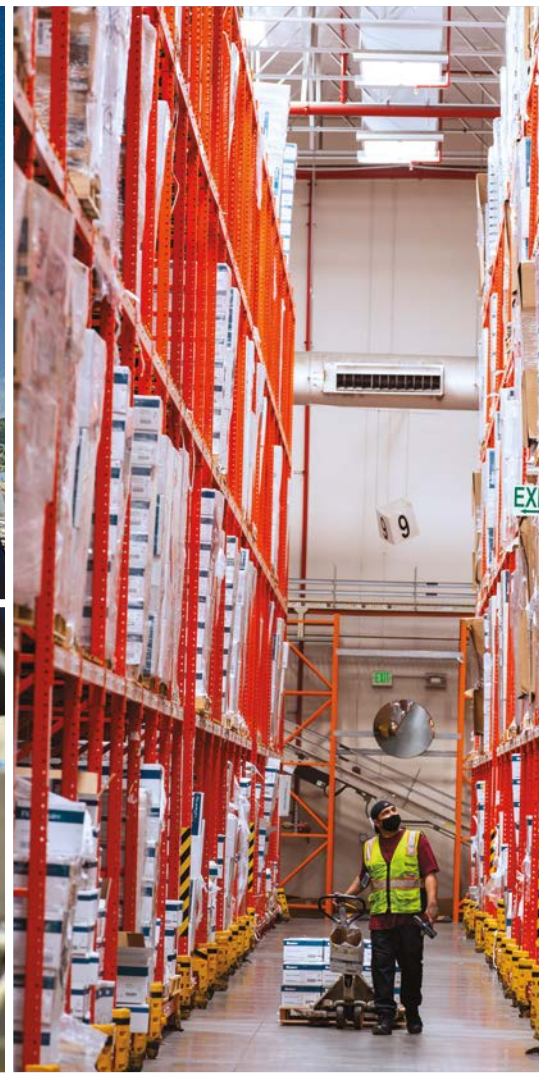

WORLD-CLASS EDUCATION, TOOLS, AND SUPPORT

For Green Industry Professionals

As your partner in business development, we know you need more than top-quality products to increase profits, provide excellent customer service, and stand out against the competition. We're proud to provide a full suite of free tools, services, and programmes to help irrigation professionals of all backgrounds succeed. Learn more at hunter.direct/tools.

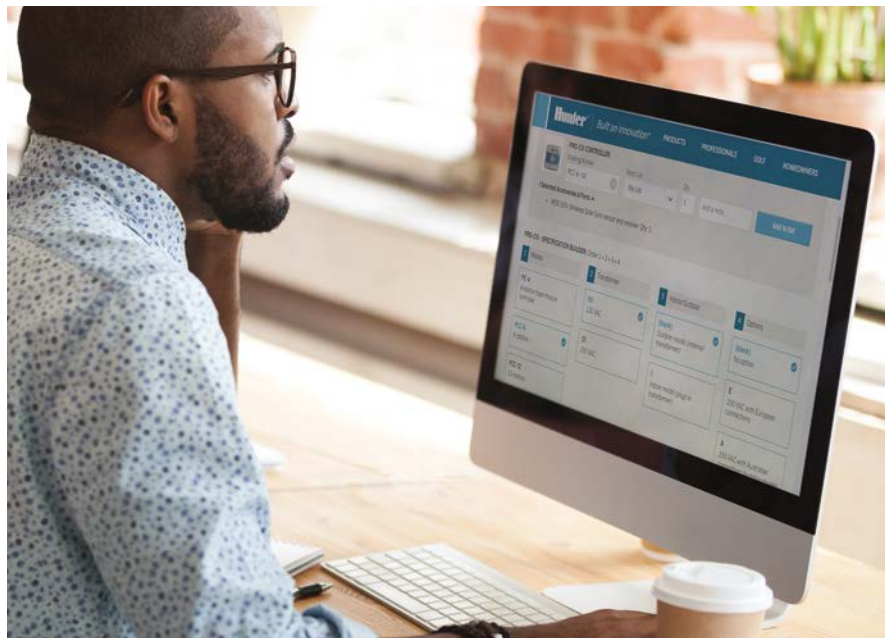

SITEREC APP

<https://hunter.info/siterecem>

Close sales faster! Confidently present proposals to your customers. Add your logo and business details for a professional presentation.



MY LIST

<https://hunter.info/mylistem>

Build customised product lists for every project. Email lists to distributors for faster ordering and add pricing and notes to each project.

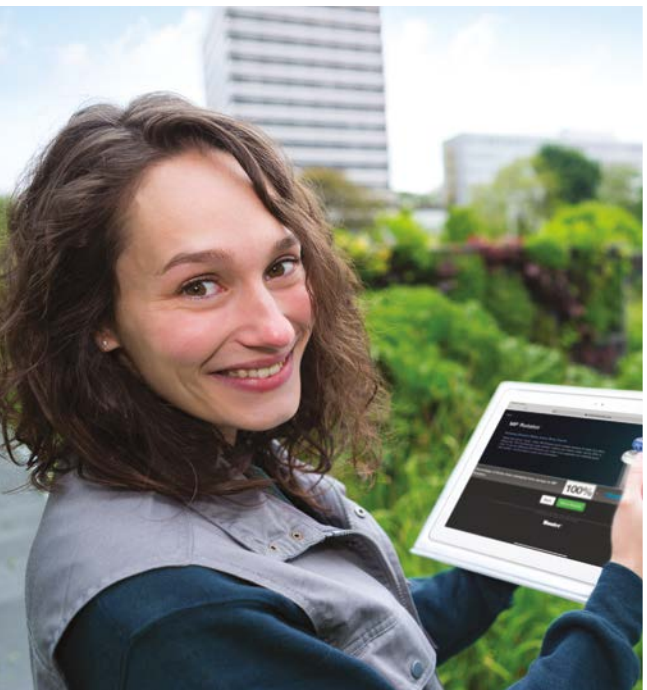

WATER SAVINGS CALCULATOR

<https://hunter.info/savingscalem>

Show your customers how much water — and money — they can save by upgrading to a more efficient irrigation system.



CAD LEGENDS

<https://hunter.info/cadlegendsem>

To help you complete projects accurately in CAD software, we offer a range of irrigation legends that show proper specification.



RUN TIME CALCULATOR

<https://hunter.info/runtimeem>

Use this helpful calculator to generate the most efficient irrigation schedule for every landscape and prevent wasteful runoff.



CAD DETAILS

<https://hunter.info/caddetailsem>

To streamline the irrigation design process, we provide installation CAD details in PDF, DWG, and DXF formats.



DRIPLINE CALCULATOR

<https://hunter.info/dripcalem>

Eliminate guesswork with this handy tool. See site recommendations, determine product quantities, and calculate run times in a simple format.



BIM 3D MODELS

<https://hunter.info/bimmodelsem>

BIM uses advanced 3D modelling to develop irrigation specification documents. Find BIM-supported products for your next project.

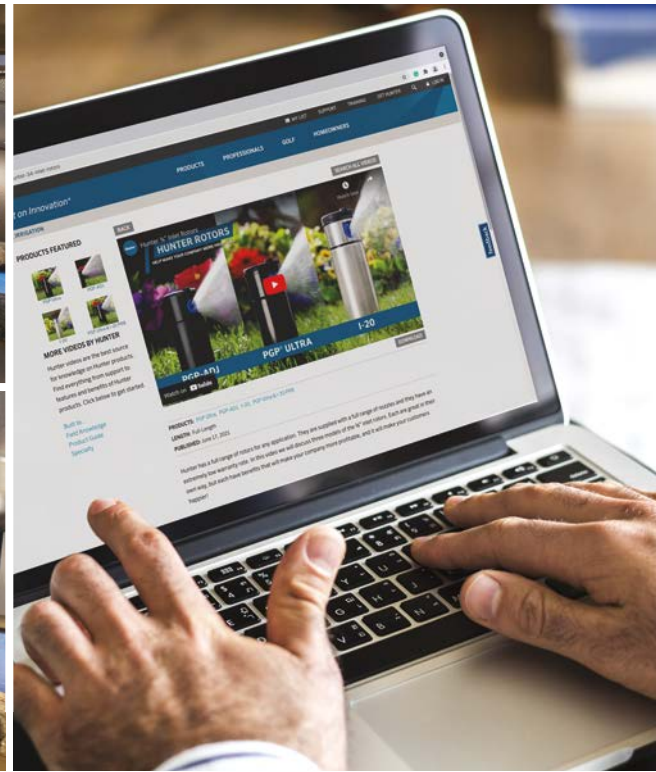

VIRTUAL ENGAGEMENT CENTER

<https://vec.hunterindustries.com>

Connect with Hunter reps and learn about our latest irrigation products in a fun, informative, and immersive digital space.



THE VAULT

<https://vault.hunterindustries.com>

Learn new facts, complete tasks to earn coins, and redeem your coins for prizes. Check back each week to see what's new.



SITE STUDY LIBRARY

<https://hunter.info/sitestudym>

See how Hunter irrigation products have transformed parks, sports fields, and outdoor living spaces around the world.



VIDEO LIBRARY

<https://hunter.info/videolibraryem>

Visit our comprehensive video library to discover key product benefits, hear from experts, find installation tips, and more.

FOLLOW US TO STAY ON TOP OF OUR LATEST PRODUCT NEWS, PROMOTIONS, INSTALLATION TIPS, AND MORE!



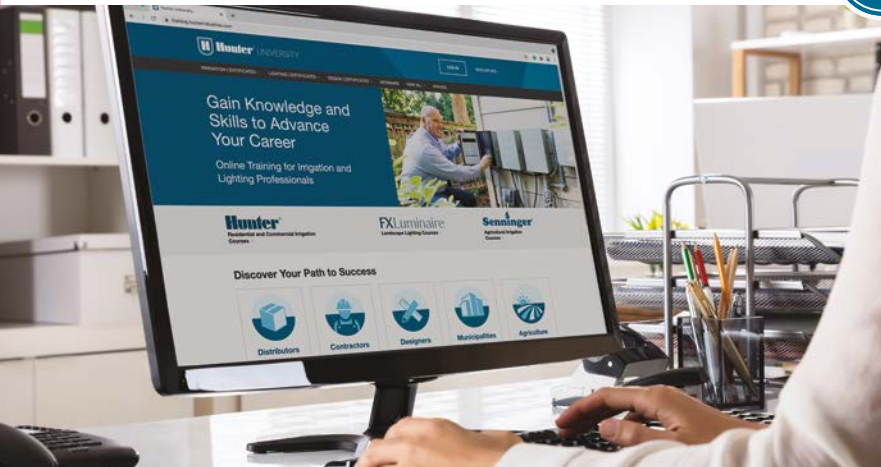

HUNTER UNIVERSITY

<https://hunter.info/hunteruniversityem>

Advance your career with our comprehensive online training certificate programmes for irrigation professionals. From fundamental product knowledge to advanced control systems and design techniques, there is a professional development programme waiting for you! Learn more at training.hunterindustries.com.

Find Your Path to Success

1. Access free online product training at training.hunterindustries.com.
2. Choose the programmes or courses that best fit your needs.

Earn certificates and badges to show off your expertise and receive continuing education credits from the Irrigation Association to meet professional requirements.

On-Site Expert Workshops

These interactive, instructor-led courses feature a hands-on approach to learning. Classes are held at the Hunter campus in San Marcos, California, and select locations worldwide. To learn more, contact training@hunterindustries.com.

New Training Programme!

Irrigation Installation Fundamentals

For reliable long-term performance, all irrigation system components must be installed correctly. Learn installation best practices today.

Irrigation Certificate Programmes

- Product Technician
- Irrigation Designer
- Hydrawise[®] Specialist
- X2[™] Specialist
- Irrigation Installation Fundamentals **◆ NEW**
- S.T.A.R. Distributor



ROTORS



ROTORS

ADVANCED FEATURES

RELIABLE STRENGTH & DURABILITY

PRESSURE-REGULATED BODY



Reduce high incoming pressure to prevent misting and allow nozzles to operate at peak efficiency. Lower pressure produces larger water droplets that fight the effects of wind.

PGP™ Ultra Shrub and 10 cm, I-20 10 and 15 cm

STAINLESS STEEL RISER



For unforgiving soil conditions, unpredictable climates, or heavy foot traffic, stainless steel is the best choice.

Standard on I-40, I-50, I-80
Optional on I-20 and I-25

DRAIN CHECK VALVE



The Drain Check Valve keeps lines from draining when the system is shut off. This saves water, reduces liability, and prolongs system life.

PGJ, PGP Ultra, I-20, I-25, I-40, I-50, I-80, I-90

VALUE-ADDED OPTIONS

OPPOSING NOZZLE 360° MODEL



The opposing nozzle design offers excellent water distribution. With primary and secondary nozzles on opposing sides of the turret, streams arc in opposite directions as the sprinkler rotates for outstanding midrange and close-in watering.

I-40, I-50, I-80, I-90

EASY IN-THE-FIELD IDENTIFICATION

OPTIONAL RECLAIMED WATER ID



Purple caps indicate where non-potable irrigation water is being used.

PGJ, PGP Ultra, I-20, I-25, I-40, I-50, I-80, I-90

COLOUR-CODED NOZZLES



Nozzles are easier to differentiate in the field for simple installation and quick organisation.

I-25, I-40, I-50, I-80, I-90

EASY AS-NEEDED ADJUSTMENTS

AUTOMATIC ARC RETURN & NON-STRIPPABLE DRIVE

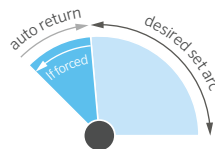

This patented feature returns the turret to the original arc regardless of where it is turned. The non-strippable drive mechanism is protected from damage, ensuring protection from vandalism.

PGP Ultra, I-20, I-25, I-40

FLOSTOP™ CONTROL



FloStop closes the flow of water from individual sprinkler heads while the system is running. This is ideal for changing nozzles or turning off specific heads during maintenance and construction.

I-20

HEADED AND SLOTTED SETSCREW



Use a slotted screwdriver or the Hunter Wrench for easier and simpler adjustments as needed.

PGJ, PGP Ultra, I-20

ROTOR COMPARISON CHART

QUICK SPECS		PGJ	SRM	PGP-ADJ	PGP ULTRA	I-20	I-25	I-40 I-50	I-40-ON I-50-ON	I-80	I-90
INLET SIZE		½"	½"	¾"	¾"	¾"	1" (25 mm)	1" (25 mm)	1" (25 mm)	1½" (40 mm)	1½" (40 mm)
RADIUS	m	4.3-11.6	4.0-9.4	6.4-15.8	4.9-14.0	4.9-14.0	11.9-21.6	13.1-23.3	15.2-23.2	19.2-29.6	22.3-31.7
FLOW	m³/hr	0.13-1.23	0.08-0.82	0.10-3.22	0.07-3.23	0.07-3.23	0.82-7.24	1.63-6.84	2.75-7.76	4.6-13.5	6.7-19.0
	l/min	2.2-20.5	1.4-13.7	1.7-53.7	1.2-53.8	1.2-53.8	13.6-120.7	27.2-114.1	45.8-129.4	76.5-225.6	111.7-317.2
FEATURES											
RECOMMENDED PRESSURE RANGE	bar	1.7-3.8	1.7-3.8	1.7-4.5	1.7-4.5	1.7-4.5	2.5-7.0	2.5-7.0	2.5-7.0	3.4-6.9	5.5-8.0
	kPa	170-380	170-380	170-450	170-450	170-450	250-700	280-700	280-700	340-690	550-800
OPERATING PRESSURE RANGE	bar	1.4-7.0	1.4-7.0	1.4-7.0	1.4-7.0	1.4-7.0	2.5-7.0	2.5-7.0	2.5-7.0	3.4-6.9	5.0-8.0
	kPa	140-700	140-700	140-700	140-700	140-700	250-700	250-700	250-700	340-690	500-800
NOZZLE TRAJECTORY		15°	15°	25°	25°	25°	25°	25°	25°	25°	22.5°
SPECIFIC NOZZLES		---	---	---	Optional	Optional	Pre-Installed	Pre-Installed	Pre-Installed	Pre-Installed	Pre-Installed
NOZZLE OPTIONS		8	6	27	34	34	11	6	6	21	16
WARRANTY		2 Years	1 Year	2 Years	5 Years	5 Years	5 Years	5 Years	5 Years	5 Years	5 Years
ADVANCED FEATURES											
LOW-ANGLE NOZZLE CHOICES				●	●	●					
AUTOMATIC ARC RETURN					●	●	●	●			
NON-STRIPPABLE DRIVE					●	●	●	●			
PART- AND FULL-CIRCLE IN ONE MODEL					●	●	●	●		●	
HEADED AND SLOTTED SETSCREW		●			●	●					
RECLAIMED WATER ID		●			●	●	●	●	●	●	●
AVAILABLE SHORT RADIUS NOZZLES					●	●					
FLOSTOP™ CONTROL						●					
OPPOSING NOZZLE									●	●	●
STAINLESS STEEL RISER OPTION						●	●	●	●	●	
OPTIONAL PRESSURE-REGULATED BODY					●	●					
OPTIONAL OR FACTORY-INSTALLED DRAIN CHECK VALVE		● (2 m)			● (3 m)	● (3 m)	● (3 m)	● (4.5 m)	● (4.5 m)	● (1.5 m)	● (2 m)

PGJ

Radius: **4.0 to 10.7 m**
Flow: **0.08 to 1.0 m³/hr; 1.4 to 16.7 l/min**

The highly durable PGJ offers all the benefits of a large rotor in a compact, spray-sized package, with water-efficient nozzles and easy arc adjustment.

KEY BENEFITS

- Headed and slotted setscrew allows radius adjustment with a Hunter Wrench or flat-blade screwdriver
- Adjustable arc from 40° to 360° to keep water in the appropriate areas
- Standard factory-installed 2.0 nozzle speeds installation
- QuickCheck™ Arc Mechanism for fast arc adjustment

OPERATING SPECIFICATIONS

- Nozzle choices: 8
- Radius: 4.0 to 10.7 m
- Flow: 0.08 to 1.0 m³/hr; 1.4 to 16.7 l/min
- Recommended pressure range: 1.7 to 3.8 bar; 170 to 380 kPa
- Operating pressure range: 1.4 to 7.0 bar; 140 to 700 kPa
- Precipitation rate: 15 mm/hr approximately
- Nozzle trajectory: 15° approximately
- Warranty period: 2 years

FACTORY-INSTALLED OPTIONS

- Drain Check Valve (up to 2.1 m of elevation) excluding PGJ-00
- Reclaimed water ID

USER-INSTALLED OPTIONS

- Drain Check Valve (up to 2.1 m of elevation) excluding PGJ-00 (P/N 462078SP)
- HC-50F-50M Check Valve (up to 9.7 m of elevation)



PGJ Reclaimed

Available as a factory-installed option on all models

PGJ - SPECIFICATION BUILDER: ORDER 1 + 2 + 3

1 Model	2 Standard Features	3 Feature Options
PGJ-00 = Shrub	Adjustable arc, 8 standard nozzles	(blank) = No option
PGJ-04 = 10 cm pop-up		V = Drain Check Valve
PGJ-06 = 15 cm pop-up		R = Drain Check Valve and reclaimed water ID
PGJ-12 = 30 cm pop-up		<i>(pop-up models only)</i>

Examples:

- PGJ-04 = 10 cm pop-up, adjustable arc
- PGJ-06 -V = 15 cm pop-up, adjustable arc, with Drain Check Valve
- PGJ-12 -R = 30 cm pop-up, adjustable arc, with Drain Check Valve and reclaimed water ID



PGJ-00

Overall height: 18 cm
Exposed diameter: 3 cm
Inlet size: ½"



PGJ-04

Overall height: 18 cm
Pop-up height: 10 cm
Exposed diameter: 3 cm
Inlet size: ½"



PGJ-06

Overall height: 23 cm
Pop-up height: 15 cm
Exposed diameter: 3 cm
Inlet size: ½"



PGJ-12

Overall height: 41 cm
Pop-up height: 30 cm
Exposed diameter: 3 cm
Inlet size: ½"

PGJ PERFORMANCE DATA							
Nozzle	Pressure		Radius m	Flow		Precip mm/hr	
	bar	kPa		m ³ /hr	l/min	■	▲
.50	1.7	170	4.3	0.08	1.4	9	11
	2.0	200	4.3	0.09	1.6	10	12
	2.5	250	4.6	0.11	1.8	10	12
	3.0	300	4.6	0.12	2.0	12	13
	3.5	350	4.9	0.13	2.2	11	13
0.75	3.8	380	4.9	0.14	2.3	12	14
	1.7	170	4.3	0.13	2.2	14	17
	2.0	200	4.6	0.14	2.4	14	16
	2.5	250	4.9	0.16	2.7	13	15
	3.0	300	5.2	0.18	3.0	13	15
1.0	3.5	350	5.2	0.19	3.2	14	17
	3.8	380	5.5	0.20	3.4	13	15
	1.7	170	5.2	0.18	3.0	13	15
	2.0	200	5.5	0.19	3.2	13	15
	2.5	250	5.5	0.21	3.5	14	16
1.5	3.0	300	5.8	0.23	3.8	14	16
	3.5	350	5.8	0.24	4.1	15	17
	3.8	380	6.1	0.25	4.2	14	16
	1.7	170	6.1	0.27	4.5	15	17
	2.0	200	6.4	0.29	4.8	14	16
2.0	2.5	250	6.4	0.32	5.4	16	18
	3.0	300	6.7	0.36	6.0	16	18
	3.5	350	6.7	0.39	6.4	17	20
	3.8	380	7.0	0.40	6.7	16	19
	1.7	170	7.0	0.34	5.6	14	16
2.5	2.0	200	7.3	0.37	6.2	14	16
	2.5	250	7.3	0.42	7.1	16	18
	3.0	300	7.6	0.48	8.0	17	19
	3.5	350	7.6	0.53	8.8	18	21
	3.8	380	7.9	0.56	9.3	18	20
3.0	1.7	170	7.9	0.46	7.6	15	17
	2.0	200	8.2	0.49	8.1	14	17
	2.5	250	8.2	0.54	9.0	16	18
	3.0	300	8.5	0.59	9.8	16	19
	3.5	350	8.5	0.63	10.5	17	20
4.0	3.8	380	8.8	0.65	10.9	17	19
	1.7	170	8.8	0.51	8.5	13	15
	2.0	200	9.1	0.56	9.3	13	15
	2.5	250	9.1	0.64	10.6	15	18
	3.0	300	9.4	0.72	12.0	16	19
4.0	3.5	350	9.4	0.78	13.1	18	20
	3.8	380	9.8	0.82	13.7	17	20
	1.7	170	9.8	0.80	13.3	17	19
	2.0	200	10.1	0.83	13.8	16	19
	2.5	250	10.1	0.89	14.8	18	20
3.0	300	10.4	0.94	15.7	17	20	
3.5	350	10.4	0.98	16.3	18	21	
3.8	380	10.7	1.00	16.7	18	20	

Note:

All precipitation rates are calculated for 180° operation. For the precipitation rate of a 360° sprinkler, divide by 2.

PGJ NOZZLES

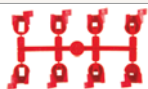

PGJ



Compatible with:

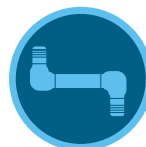

SJ Swing Joints
Page 72

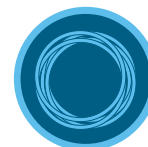

Hunter FlexSG
Page 72

SRM

The SRM is an economical short-range rotor that offers a convenient and efficient alternative to spray heads.

Radius: **4.0 to 10.7 m**
Flow: **0.08 to 1.0 m³/hr; 1.4 to 16.7 l/min**

KEY BENEFITS

- Adjustable arc from 40° to 360° to keep water in the appropriate areas
- Standard factory-installed 2.0 nozzle speeds installation
- QuickCheck™ Arc Mechanism for fast arc adjustment

OPERATING SPECIFICATIONS

- Nozzle choices: 8
- Radius: 4.0 to 10.7 m
- Flow: 0.08 to 1.0 m³/hr; 1.4 to 16.7 l/min
- Recommended pressure range: 1.7 to 3.8 bar; 170 to 380 kPa
- Operating pressure range: 1.4 to 7.0 bar; 140 to 700 kPa
- Precipitation rate: 11 mm/hr approximately
- Nozzle trajectory: 14° approximately
- Warranty period: 1 year

USER-INSTALLED OPTIONS

- Drain Check Valve (up to 2.1 m of elevation) (P/N 462078SP)

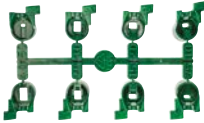
SRM		SRM NOZZLES
Model	Description	
SRM-04	10 cm pop-up, adjustable arc, 8 standard nozzles	

SRM



Compatible with:



SJ Swing Joints
Page 72



Hunter FlexSG
Page 72



SRM-04

Overall height: 18 cm
Pop-up height: 10 cm
Exposed diameter: 3 cm
Inlet size: ½"

SRM-04 PERFORMANCE DATA

Nozzle	Pressure		Radius m	Flow		Precip in/hr	
	bar	kPa		m ³ /hr	l/min		
0.50	1.7	170	4.3	0.08	1.4	9	11
	2.0	200	4.3	0.09	1.6	10	12
	2.5	250	4.6	0.11	1.8	10	12
	3.0	300	4.6	0.12	2.0	12	13
	3.5	350	4.9	0.13	2.2	11	13
	3.8	380	4.9	0.14	2.3	12	14
0.75	1.7	170	4.3	0.13	2.2	14	17
	2.0	200	4.6	0.14	2.4	14	16
	2.5	250	4.9	0.16	2.7	13	15
	3.0	300	5.2	0.18	3.0	13	15
	3.5	350	5.2	0.19	3.2	14	17
	3.8	380	5.5	0.20	3.4	13	15
1.0	1.7	170	5.2	0.18	3.0	13	15
	2.0	200	5.5	0.19	3.2	13	15
	2.5	250	5.5	0.21	3.5	14	16
	3.0	300	5.8	0.23	3.8	14	16
	3.5	350	5.8	0.24	4.1	15	17
	3.8	380	6.1	0.25	4.2	14	16
1.5	1.7	170	6.1	0.27	4.5	15	17
	2.0	200	6.4	0.29	4.8	14	16
	2.5	250	6.4	0.32	5.4	16	18
	3.0	300	6.7	0.36	6.0	16	18
	3.5	350	6.7	0.39	6.4	17	20
	3.8	380	7.0	0.40	6.7	16	19
2.0	1.7	170	7.0	0.34	5.6	14	16
	2.0	200	7.3	0.37	6.2	14	16
	2.5	250	7.3	0.42	7.1	16	18
	3.0	300	7.6	0.48	8.0	17	19
	3.5	350	7.6	0.53	8.8	18	21
	3.8	380	7.9	0.56	9.3	18	20
2.5	1.7	170	7.9	0.46	7.6	15	17
	2.0	200	8.2	0.49	8.1	14	17
	2.5	250	8.2	0.54	9.0	16	18
	3.0	300	8.5	0.59	9.8	16	19
	3.5	350	8.5	0.63	10.5	17	20
	3.8	380	8.8	0.65	10.9	17	19
3.0	1.7	170	8.8	0.51	8.5	13	15
	2.0	200	9.1	0.56	9.3	13	15
	2.5	250	9.1	0.64	10.6	15	18
	3.0	300	9.4	0.72	12.0	16	19
	3.5	350	9.4	0.78	13.1	18	20
	3.8	380	9.8	0.82	13.7	17	20
4.0	1.7	170	9.8	0.80	13.3	17	19
	2.0	200	10.1	0.83	13.8	16	19
	2.5	250	10.1	0.89	14.8	18	20
	3.0	300	10.4	0.94	15.7	17	20
	3.5	350	10.4	0.98	16.3	18	21
	3.8	380	10.7	1.00	16.7	18	20

Note:

All precipitation rates are calculated for 180° operation. For the precipitation rate of a 360° sprinkler, divide by 2.

PGP™

As Hunter's original rotor, the PGP delivers unsurpassed reliability, durability, versatility, and value, keeping it the professional's choice year after year.

Radius: **6.4 to 15.8 m**
Flow: **0.10 to 3.22 m³/hr; 1.7 to 53.7 l/min**

KEY BENEFITS

- Three types of nozzles available for various landscapes: standard red, standard blue, grey low-angle
- Adjustable arc from 40° to 360° to keep water in the appropriate areas
- Factory-installed rubber cover for safety
- Through-the-top arc adjustment for easy installation
- QuickCheck™ Arc Mechanism for fast arc adjustment

OPERATING SPECIFICATIONS

- Nozzle choices: 27
- Radius: 6.4 to 15.8 m
- Flow: 0.10 to 3.22 m³/hr; 1.7 to 53.7 l/min
- Recommended pressure range: 1.7 to 4.5 bar; 170 to 450 kPa
- Operating pressure range: 1.4 to 7.0 bar; 140 to 700 kPa
- Precipitation rate: 10 mm/hr approximately
- Nozzle trajectory: standard = 25°, low-angle = 13°
- Warranty period: 2 years

FACTORY-INSTALLED OPTIONS

- Red #5-#8 Nozzle; Blue #1.5-4.0

USER-INSTALLED OPTIONS

- Drain Check Valve (up to 1 m of elevation) P/N 142300SP



PGP-ADJ

Overall height: 19 cm
Pop-up height: 10 cm
Exposed diameter: 4 cm
Inlet size: ¾"

ROTORS



PGP-ADJ

Easy arc and radius adjustment

PGP-ADJ – SPECIFICATION BUILDER: ORDER 1 + 2 + 3

1 Model	2 Standard Features	3 Feature Options
PGP-ADJ-B = 10 cm pop-up	Adjustable arc with blue nozzle rack	1.5 to 4.0 = Factory-installed blue nozzle number
PGP-ADJ = 10 cm pop-up	Adjustable arc with red nozzle rack	#5 to #8 = Factory-installed red nozzle number

Examples:

- PGP-ADJ = 10 cm pop-up, adjustable arc
- PGP-ADJ-B-3.0 = 10 cm pop-up, adjustable arc, and #3.0 blue nozzle
- PGP-ADJ -07 = 10 cm pop-up, adjustable arc, and #7 red nozzle

PGP Red Nozzle



PGP BLUE NOZZLE PERFORMANCE DATA

Nozzle	Pressure		Radius m	Flow		Precip mm/hr	
	bar	kPa		m ³ /hr	l/min	■	▲
1.5 Blue	1.7	170	8.8	0.27	4.5	7	8
	2.0	200	9.1	0.29	4.8	7	8
	2.5	250	9.4	0.32	5.4	7	8
	3.0	300	9.8	0.35	5.9	7	9
	3.5	350	9.8	0.38	6.4	8	9
	4.0	400	9.8	0.41	6.8	9	10
4.5	450	9.4	0.43	7.2	10	11	
2.0 Blue	1.7	170	10.1	0.32	5.4	6	7
	2.0	200	10.1	0.35	5.8	7	8
	2.5	250	10.1	0.39	6.5	8	9
	3.0	300	10.4	0.43	7.2	8	9
	3.5	350	10.4	0.47	7.8	9	10
	4.0	400	10.4	0.50	8.3	9	11
4.5	450	10.4	0.53	8.8	10	11	
2.5 Blue	1.7	170	10.1	0.39	6.6	8	9
	2.0	200	10.4	0.43	7.1	8	9
	2.5	250	10.7	0.48	8.0	8	10
	3.0	300	10.7	0.54	8.9	9	11
	3.5	350	10.7	0.58	9.7	10	12
	4.0	400	10.7	0.62	10.4	11	13
4.5	450	10.7	0.66	11.1	12	13	
3.0 Blue	1.7	170	10.7	0.50	8.4	9	10
	2.0	200	10.7	0.54	9.1	10	11
	2.5	250	11.0	0.61	10.2	10	12
	3.0	300	11.6	0.68	11.4	10	12
	3.5	350	11.9	0.74	12.3	10	12
	4.0	400	11.9	0.79	13.2	11	13
4.5	450	11.9	0.84	14.0	12	14	
4.0 Blue	1.7	170	11.3	0.68	11.3	11	12
	2.0	200	11.6	0.73	12.2	11	13
	2.5	250	11.9	0.81	13.6	12	13
	3.0	300	12.2	0.90	15.0	12	14
	3.5	350	12.2	0.97	16.2	13	15
	4.0	400	12.5	1.04	17.3	13	15
4.5	450	12.5	1.10	18.3	14	16	
5.0 Blue	1.7	170	11.3	0.84	14.0	13	15
	2.0	200	11.6	0.91	15.2	14	16
	2.5	250	11.9	1.02	17.1	15	17
	3.0	300	12.8	1.14	19.0	14	16
	3.5	350	12.8	1.24	20.6	15	17
	4.0	400	12.8	1.32	22.1	16	19
4.5	450	12.8	1.41	23.4	17	20	
6.0 Blue	1.7	170	11.6	1.01	16.8	15	17
	2.0	200	11.9	1.09	18.2	15	18
	2.5	250	12.2	1.22	20.4	16	19
	3.0	300	13.1	1.36	22.7	16	18
	3.5	350	13.1	1.47	24.5	17	20
	4.0	400	13.4	1.57	26.2	18	20
4.5	450	13.4	1.67	27.9	19	21	
8.0 Blue	1.7	170	11.3	1.35	22.5	21	25
	2.0	200	11.9	1.46	24.3	21	24
	2.5	250	12.5	1.63	27.2	21	24
	3.0	300	13.4	1.81	30.2	20	23
	3.5	350	13.7	1.95	32.6	21	24
	4.0	400	14.0	2.09	34.8	21	25
4.5	450	14.0	2.22	36.9	23	26	

Note:
All precipitation rates are calculated for 180° operation. For the precipitation rate of a 360° sprinkler, divide by 2.

PGP GREY LOW-ANGLE NOZZLE PERFORMANCE DATA

Nozzle	Pressure		Radius m	Flow		Precip mm/hr	
	bar	kPa		m ³ /hr	l/min	■	▲
4 LA Grey	1.7	170	6.4	0.30	4.9	14	17
	2.0	200	6.7	0.32	5.3	14	16
	2.5	250	7.0	0.35	5.9	14	17
	3.0	300	7.3	0.39	6.5	15	17
	3.5	350	7.9	0.42	7.0	13	15
	4.0	400	8.5	0.45	7.5	12	14
4.5	450	8.5	0.47	7.9	13	15	
5 LA Grey	1.7	170	7.3	0.33	5.6	12	14
	2.0	200	7.6	0.36	6.0	12	14
	2.5	250	7.9	0.40	6.7	13	15
	3.0	300	8.2	0.45	7.4	13	15
	3.5	350	8.5	0.48	8.0	13	15
	4.0	400	8.8	0.52	8.6	13	15
4.5	450	9.1	0.55	9.1	13	15	
6 LA Grey	1.7	170	8.8	0.44	7.3	11	13
	2.0	200	9.1	0.47	7.9	11	13
	2.5	250	9.4	0.53	8.8	12	14
	3.0	300	9.8	0.59	9.8	12	14
	3.5	350	10.1	0.64	10.6	13	15
	4.0	400	10.7	0.68	11.3	12	14
4.5	450	10.7	0.72	12.0	13	15	
7 LA Grey	1.7	170	8.5	0.58	9.7	16	18
	2.0	200	8.8	0.62	10.3	16	18
	2.5	250	9.4	0.68	11.4	15	18
	3.0	300	10.1	0.75	12.5	15	17
	3.5	350	10.7	0.80	13.3	14	16
	4.0	400	11.3	0.85	14.1	13	15
4.5	450	11.3	0.89	14.8	14	16	
8 LA Grey	1.7	170	9.1	0.71	11.8	17	20
	2.0	200	9.4	0.76	12.7	17	20
	2.5	250	9.8	0.84	14.1	18	20
	3.0	300	10.4	0.93	15.5	17	20
	3.5	350	11.3	1.00	16.6	16	18
	4.0	400	11.6	1.06	17.6	16	18
4.5	450	11.6	1.12	18.6	17	19	
9 LA Grey	1.7	170	9.8	0.89	14.9	19	22
	2.0	200	10.1	0.96	16.0	19	22
	2.5	250	10.7	1.07	17.9	19	22
	3.0	300	11.3	1.19	19.8	19	22
	3.5	350	12.2	1.28	21.3	17	20
	4.0	400	12.8	1.37	22.8	17	19
4.5	450	12.8	1.45	24.1	18	20	
10 LA Grey	1.7	170	10.1	1.17	19.5	23	27
	2.0	200	10.7	1.26	21.0	22	26
	2.5	250	11.3	1.40	23.4	22	25
	3.0	300	11.6	1.55	25.9	23	27
	3.5	350	12.2	1.67	27.8	22	26
	4.0	400	12.8	1.78	29.7	22	25
4.5	450	12.8	1.89	31.4	23	27	

Note:
All precipitation rates are calculated for 180° operation. For the precipitation rate of a 360° sprinkler, divide by 2.

PGP NOZZLES

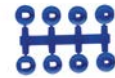

Blue
(P/N 665300)



Grey
(P/N 233200)



PGP RED NOZZLE PERFORMANCE DATA							
Nozzle	Pressure		Radius m	Flow		Precip mm/hr	
	bar	kPa		m ³ /hr	l/min	■	▲
1 Red	1.7	170	8.2	0.10	1.7	3	3
	2.0	200	8.5	0.11	1.8	3	3
	2.5	250	8.5	0.13	2.1	4	4
	3.0	300	8.8	0.15	2.4	4	4
	3.5	350	8.8	0.16	2.7	4	5
	4.0	400	9.1	0.18	2.9	4	5
	4.5	450	9.1	0.19	3.2	5	5
2 Red	1.7	170	8.5	0.14	2.4	4	5
	2.0	200	8.8	0.16	2.6	4	5
	2.5	250	8.8	0.17	2.9	4	5
	3.0	300	9.1	0.19	3.2	5	5
	3.5	350	9.1	0.21	3.5	5	6
	4.0	400	9.4	0.22	3.7	5	6
	4.5	450	9.4	0.23	3.9	5	6
3 Red	1.7	170	8.8	0.18	3.0	5	5
	2.0	200	9.1	0.20	3.3	5	5
	2.5	250	9.1	0.22	3.7	5	6
	3.0	300	9.4	0.25	4.1	6	6
	3.5	350	9.4	0.27	4.5	6	7
	4.0	400	9.8	0.29	4.8	6	7
	4.5	450	9.8	0.31	5.1	6	7
4 Red	1.7	170	9.4	0.24	4.1	5	6
	2.0	200	9.8	0.27	4.4	6	6
	2.5	250	9.8	0.30	5.0	6	7
	3.0	300	10.1	0.34	5.6	7	8
	3.5	350	10.1	0.37	6.2	7	8
	4.0	400	10.4	0.40	6.6	7	9
	4.5	450	10.4	0.43	7.1	8	9
5 Red	1.7	170	10.1	0.33	5.5	7	8
	2.0	200	10.4	0.36	5.9	7	8
	2.5	250	10.4	0.39	6.5	7	8
	3.0	300	11.0	0.43	7.2	7	8
	3.5	350	11.6	0.46	7.7	7	8
	4.0	400	11.6	0.49	8.1	7	8
	4.5	450	11.6	0.51	8.6	8	9
6 Red	1.7	170	10.1	0.42	6.9	8	10
	2.0	200	10.4	0.45	7.5	8	10
	2.5	250	10.7	0.51	8.5	9	10
	3.0	300	11.0	0.57	9.4	9	11
	3.5	350	11.6	0.61	10.2	9	11
	4.0	400	11.6	0.66	10.9	10	11
	4.5	450	11.9	0.70	11.6	10	11
7 Red	1.7	170	10.1	0.54	9.0	11	12
	2.0	200	10.4	0.58	9.7	11	12
	2.5	250	11.0	0.65	10.8	11	12
	3.0	300	11.6	0.72	12.0	11	12
	3.5	350	12.2	0.78	12.9	10	12
	4.0	400	12.2	0.83	13.8	11	13
	4.5	450	12.2	0.88	14.6	12	14

PGP RED NOZZLE PERFORMANCE DATA							
Nozzle	Pressure		Radius m	Flow		Precip mm/hr	
	bar	kPa		m ³ /hr	l/min	■	▲
8 Red	1.7	170	11.0	0.66	11.0	11	13
	2.0	200	11.3	0.71	11.8	11	13
	2.5	250	11.6	0.79	13.2	12	14
	3.0	300	11.9	0.87	14.5	12	14
	3.5	350	12.5	0.94	15.6	12	14
	4.0	400	12.5	1.00	16.6	13	15
	4.5	450	12.8	1.05	17.6	13	15
9 Red	1.7	170	11.3	0.73	12.2	11	13
	2.0	200	11.6	0.80	13.4	12	14
	2.5	250	11.6	0.92	15.4	14	16
	3.0	300	12.5	1.05	17.5	13	16
	3.5	350	13.4	1.15	19.2	13	15
	4.0	400	13.4	1.25	20.9	14	16
	4.5	450	13.7	1.35	22.4	14	17
10 Red	2.0	200	12.2	1.14	19.0	15	18
	2.5	250	12.8	1.29	21.4	16	18
	3.0	300	13.4	1.44	24.0	16	18
	3.5	350	14.0	1.56	26.1	16	18
	4.0	400	14.3	1.68	28.0	16	19
	4.5	450	14.3	1.79	29.9	17	20
	5.0	500	14.6	1.90	31.7	18	21
11 Red	2.0	200	12.8	1.55	25.9	19	22
	2.5	250	13.7	1.73	28.7	18	21
	3.0	300	14.0	1.90	31.7	19	22
	3.5	350	14.6	2.05	34.1	19	22
	4.0	400	14.9	2.18	36.3	20	23
	4.5	450	15.2	2.30	38.4	20	23
	5.0	500	15.5	2.42	40.4	20	23
12 Red	2.0	200	12.8	2.03	33.8	25	29
	2.5	250	13.4	2.26	37.7	25	29
	3.0	300	14.3	2.51	41.8	24	28
	3.5	350	14.6	2.70	45.0	25	29
	4.0	400	14.9	2.88	48.1	26	30
	4.5	450	15.2	3.06	50.9	26	30
	5.0	500	15.8	3.22	53.7	26	30

Note:

All precipitation rates are calculated for 180° operation. For the precipitation rate of a 360° sprinkler, divide by 2.

PGP NOZZLES



Red
(P/N 130900)



PGP™ ULTRA

Radius: **4.9 to 14.0 m**
Flow: **0.07 to 3.23 m³/hr; 1.2 to 53.8 l/min**

The PGP Ultra raises the bar for rotor technology with powerful features developed over three decades of research, customer feedback, and lab testing.

KEY BENEFITS

- Patented automatic arc return feature returns the turret back to the original arc pattern if vandalised; adjustable arc from 50° to 360°
- Non-strippable drive mechanism is protected from damage if turned in the opposite direction of travel
- Part- and full-circle in one model for flexibility across landscapes and reduced inventory
- Headed and slotted setscrew allows radius adjustment with a Hunter Wrench or flat-blade screwdriver
- Flat-top nozzles allow fast, easy insertion
- QuickCheck™ Arc Mechanism for fast arc adjustment

OPERATING SPECIFICATIONS

- Nozzle choices: 34
- Radius: 4.9 to 14.0 m
- Flow: 0.07 to 3.23 m³/hr; 1.2 to 53.8 l/min
- Recommended pressure range: 1.7 to 4.5 bar; 170 to 450 kPa
- Operating pressure range: 1.4 to 7.0 bar; 140 to 700 kPa
- Precipitation rate: 10 mm/hr approximately
- Nozzle trajectory: standard = 25°, low-angle = 13°
- Nozzle racks: 1.5 to 8.0 blue, 2.0 to 4.5 low-angle grey, 0.50 to 3.0 black, 6.0 to 13.0 green, MPR-25, MPR-30, MPR-35
- Warranty period: 5 years

FACTORY-INSTALLED OPTIONS

- Drain Check Valve (up to 3 m of elevation)
- Reclaimed water ID
- Blue #1.5-4.0 Nozzles

USER-INSTALLED OPTIONS

- Drain Check Valve (up to 1 m of elevation) PGP-04 only (P/N 142300SP)
- HSJ-0 prefabricated ¾" PVC Swing Joint



PGP Ultra Reclaimed

Available as a factory-installed option on all models



PGP Ultra

Easy arc and radius adjustment



PGP-00

Overall height: 19 cm
Exposed diameter: 4.5 cm
Inlet size: ¾"



PGP-04

Overall height: 19 cm
Pop-up height: 10 cm
Exposed diameter: 4.5 cm
Inlet size: ¾"



PGP-06

Overall height: 25 cm
Pop-up height: 15 cm
Exposed diameter: 4.5 cm
Inlet size: ¾"



PGP-12

Overall height: 43 cm
Pop-up height: 30 cm
Exposed diameter: 4.5 cm
Inlet size: ¾"

PGP-ULTRA - SPECIFICATION BUILDER: ORDER 1 + 2 + 3 + 4

1 Model	2 Standard Features	3 Feature Options	4 Nozzle Options
PGP-00 = Shrub	Adjustable arc, plastic riser, 8 standard nozzles, and 4 low-angle nozzles	CV = Drain Check Valve	Blue 1.5-8.0 Grey low-angle Black short-radius Green high-flow MPR-25-Q, T, H, F MPR-30-Q, T, H, F MPR-35-Q, T, H, F 1.5 to 4.0 = Only nozzles 1.5-4.0 can be factory-installed
PGP-04 = 10 cm pop-up		CV-R = Drain Check Valve and reclaimed water ID	
PGP-06 = 15 cm pop-up			
PGP-12 = 30 cm pop-up			

Examples:

PGP-04 = 10 cm pop-up, adjustable arc

PGP-04-2.5 = 10 cm pop-up, adjustable arc and 2.5 nozzle

PGP-12-CV-R-4.0 = 30 cm pop-up, adjustable arc, with Drain Check Valve and reclaimed water ID with 4.0 nozzle

I-20

Radius: **4.9 to 14.0 m**
Flow: **0.07 to 3.23 m³/hr; 1.2 to 53.8 l/min**

The I-20 is loaded with upgraded features such as FloStop Control, check valves, and efficient nozzles that make it the perfect choice in a range of applications.

KEY BENEFITS

- Patented automatic arc return feature returns the turret back to the original arc pattern if vandalised; adjustable arc from 50° to 360°
- Non-strippable drive mechanism is protected from damage if turned in the opposite direction of travel
- Part and full-circle in one model is flexible for all landscapes and decreases inventory
- Headed and slotted setscrew allows radius adjustment with a Hunter Wrench or flat-blade screwdriver
- FloStop™ closes the flow of water from individual sprinklers to change the nozzle or perform repairs
- Flat-top nozzles allow fast, easy insertion
- Drain Check Valve prevents low-head drainage (up to 3 m of elevation)

OPERATING SPECIFICATIONS

- Nozzle choices: 34
- Radius: 4.9 to 14.0 m
- Flow: 0.07 to 3.23 m³/hr; 1.2 to 53.8 l/min
- Recommended pressure range: 1.7 to 4.5 bar; 170 to 450 kPa
- Operating pressure range: 1.4 to 7.0 bar; 140 to 700 kPa
- Precipitation rate: 10 mm/hr approximately
- Nozzle trajectory: standard = 25°, low-angle = 13°
- Nozzle racks: 1.5 to 8.0 blue, 2.0 to 4.5 low-angle grey, 0.50 to 3.0 black, 6.0 to 13.0 green, MPR-25, MPR-30, MPR-35
- Warranty period: 5 years

FACTORY-INSTALLED OPTIONS

- No Drain Check Valve (NCV models)
- Reclaimed water ID
- Blue #1.5-4.0 Nozzles



I-20 Reclaimed

Available as a factory-installed option on all models

USER-INSTALLED OPTIONS

- HSJ-0 prefabricated 3/4" PVC Swing Joint

I-20 (PLASTIC) - SPECIFICATION BUILDER: ORDER 1 + 2 + 3 + 4

1 Model	2 Standard Features	3 Feature Options	4 Nozzle Options
I-20-00 = Shrub I-20-04 = 10 cm pop-up I-20-06 = 15 cm pop-up I-20-12 = 30 cm pop-up	Adjustable arc, plastic, check valve, 8 standard nozzles, and 4 low-angle nozzles	(blank) = No option NCV = Without check valve (only available on 10 cm model) R = Reclaimed water ID	Blue 1.5-8.0 Grey low-angle Black short-radius Green high-flow MPR-25-Q, T, H, F MPR-30-Q, T, H, F MPR-35-Q, T, H, F 1.5 to 4.0 = Only nozzles 1.5-4.0 can be factory-installed

I-20 (STAINLESS STEEL) - SPECIFICATION BUILDER: ORDER 1 + 2 + 3 + 4

1 Model	2 Standard Features	3 Feature Options	4 Nozzle Options
I-20-04-SS = 10 cm pop-up I-20-06-SS = 15 cm pop-up	Adjustable arc, stainless steel, check valve, 8 standard nozzles, and 4 low-angle nozzles	(blank) = No option NCV = Without check valve (only available on 10 cm model) R = Reclaimed water ID	Blue 1.5-8.0 Grey low-angle Black short-radius Green high-flow MPR-25-Q, T, H, F MPR-30-Q, T, H, F MPR-35-Q, T, H, F 1.5 to 4.0 = Only nozzles 1.5-4.0 can be factory-installed

Examples:

- I-20-04 = 10 cm pop-up, adjustable arc
- I-20-12-R-4.0 = 30 cm pop-up, adjustable arc, check valve, with reclaimed water ID, and 4.0 nozzle
- I-20-06-SS-R-3.0 = 15 cm pop-up, adjustable arc, stainless steel riser, with reclaimed water ID, and 3.0 nozzle



I-20-00

Overall height: 20 cm
Exposed diameter: 4.5 cm
Inlet size: 3/4"



I-20-04

Overall height: 19 cm
Pop-up height: 10 cm
Exposed diameter: 4.5 cm
Inlet size: 3/4"



I-20-06

Overall height: 25 cm
Pop-up height: 15 cm
Exposed diameter: 4.5 cm
Inlet size: 3/4"



I-20-12

Overall height: 43 cm
Pop-up height: 30 cm
Exposed diameter: 4.5 cm
Inlet size: 3/4"

PGP™ ULTRA & I-20 PRB

Radius: **4.9 to 14.0 m**
Flow: **0.07 to 2.22 m³/hr; 1.2 to 36.0 l/min**

The PGP Ultra and I-20 PRB are built to thrive in applications where high water pressure could otherwise lead to inefficient nozzle operation.

KEY BENEFITS

- Pressure-regulated body (3.1 bar; 310 kPa) reduces high incoming pressure to increase nozzle efficiency (requires dynamic pressure differential: 1.0 bar; 103 kPa)
- Patented automatic arc return feature returns the turret back to the original arc pattern if vandalised; adjustable arc from 50° to 360°
- Non-strippable drive mechanism is protected from damage if turned in the opposite direction of travel
- Part- and full-circle in one model for flexibility across landscapes and reduced inventory
- Headed and slotted setscrew allows radius adjustment with a Hunter Wrench or flat-blade screwdriver
- FloStop™ closes the flow of water from individual sprinklers, to change the nozzle or perform repairs (I-20 only)
- Flat-top nozzles allow fast, easy insertion
- Drain Check Valve prevents low-head drainage (up to 3 m of elevation)

OPERATING SPECIFICATIONS

- Nozzle choices: 30
- Radius: 4.9 to 14.0 m
- Flow: 0.07 to 2.22 m³/hr; 1.2 to 36.0 l/min
- Nozzle discharge pressure: 3.1 bar; 310 kPa
- Operating pressure range: 4.1 to 7.0 bar; 410 to 700 kPa
- Precipitation rate: 10 mm/hr approximately
- Nozzle trajectory: standard = 25°, low-angle = 13°
- Nozzle racks: 1.5 to 8.0 blue, 2.0 to 4.5 low-angle grey, 0.50 to 3.0 black, MPR-25, MPR-30, MPR-35
- Warranty period: 5 years

FACTORY-INSTALLED OPTIONS

- Reclaimed water ID
- Blue #1.5-4.0 Nozzels

USER-INSTALLED OPTIONS

- HSJ-0 prefabricated ¾" PVC Swing Joint



PGP-00-PRB

Overall height: 22 cm
Exposed diameter: 4.5 cm
Inlet size: ¾"

PGP-04-PRB

Overall height: 22 cm
Pop-up height: 10 cm
Exposed diameter: 4.5 cm
Inlet size: ¾"



I-20-00-PRB

Overall height: 22 cm
Exposed diameter: 4.5 cm
Inlet size: ¾"

I-20-04-PRB

Overall height: 22 cm
Pop-up height: 10 cm
Exposed diameter: 4.5 cm
Inlet size: ¾"



I-20-06-PRB

Overall height: 27 cm
Pop-up height: 15 cm
Exposed diameter: 4.5 cm
Inlet size: ¾"

PGP-ULTRA & I-20 PRB – SPECIFICATION BUILDER: ORDER 1 + 2 + 3 + 4

1 Model	2 Standard Features	3 Feature Options	4 Nozzle Options
PGP-00-PRB = Riser mount PGP-04-PRB = 10 cm pop-up	Adjustable arc, plastic riser, pressure-regulated body, 8 standard nozzles, and 4 low-angle nozzles	(blank) = No option CV = Drain Check Valve (PGP-04 only) CV-R = Drain Check Valve and reclaimed water ID	Blue 1.5-8.0 = Grey low-angle Black short-radius MPR-25, 30, 35 - Q, T, H, F
I-20-00-PRB = Riser mount I-20-04-PRB = 10 cm pop-up I-20-06-PRB = 15 cm pop-up	Adjustable arc, plastic riser, pressure-regulated body, 8 standard nozzles, and 4 low-angle nozzles	(blank) = No option R = Drain Check Valve and reclaimed water ID	Blue 1.5-8.0 = Grey low-angle Black short-radius MPR-25, 30, 35 - Q, T, H, F
I-20-04-SS-PRB = 10 cm pop-up I-20-06-SS-PRB = 15 cm pop-up	Adjustable arc, stainless steel riser, pressure-regulated body, 8 standard nozzles, and 4 low-angle nozzles	(blank) = No option R = Drain Check Valve and reclaimed water ID	Blue 1.5-8.0 = Grey low-angle Black short-radius MPR-25, 30, 35 - Q, T, H, F

Examples:

PGP-04-PRB = 10 cm pop-up, adjustable arc, plastic riser with no factory installed-nozzle
 I-20-04-PRB-3.0-2.5 = 10 cm pop-up, adjustable arc, plastic riser with 3.0 nozzle
 I-20-06-SS-PRB-R-MPR-25H = 15 cm pop-up, adjustable arc, stainless steel riser with MPR-25H

PGP ULTRA / I-20 / PRB BLUE STANDARD NOZZLE PERFORMANCE DATA

Nozzle	Pressure		Radius m	Flow		Precip mm/hr	
	bar	kPa		m ³ /hr	l/min	■	▲
1.5 ● Blue	1.7	170	8.8	0.27	4.5	7	8
	2.0	200	9.1	0.29	4.8	7	8
	2.5	250	9.4	0.32	5.4	7	8
	3.0	300	9.8	0.35	5.9	7	9
	3.5	350	9.8	0.38	6.4	8	9
	4.0	400	9.8	0.41	6.8	9	10
2.0 ● Blue	1.7	170	10.1	0.32	5.4	6	7
	2.0	200	10.1	0.35	5.8	7	8
	2.5	250	10.1	0.39	6.5	8	9
	3.0	300	10.4	0.43	7.2	8	9
	3.5	350	10.4	0.47	7.8	9	10
	4.0	400	10.4	0.50	8.3	9	11
2.5 ● Blue	1.7	170	10.1	0.39	6.6	8	9
	2.0	200	10.4	0.43	7.1	8	9
	2.5	250	10.7	0.48	8.0	8	10
	3.0	300	10.7	0.54	8.9	9	11
	3.5	350	10.7	0.58	9.7	10	12
	4.0	400	10.7	0.62	10.4	11	13
3.0 ● Blue	1.7	170	10.7	0.50	8.4	9	10
	2.0	200	10.7	0.54	9.1	10	11
	2.5	250	11.0	0.61	10.2	10	12
	3.0	300	11.6	0.68	11.4	10	12
	3.5	350	11.9	0.74	12.3	10	12
	4.0	400	11.9	0.79	13.2	11	13
4.0 ● Blue	1.7	170	11.3	0.68	11.3	11	12
	2.0	200	11.6	0.73	12.2	11	13
	2.5	250	11.9	0.81	13.6	12	13
	3.0	300	12.2	0.90	15.0	12	14
	3.5	350	12.2	0.97	16.2	13	15
	4.0	400	12.5	1.04	17.3	13	15
5.0 ● Blue	1.7	170	11.3	0.84	14.0	13	15
	2.0	200	11.6	0.91	15.2	14	16
	2.5	250	11.9	1.02	17.1	15	17
	3.0	300	12.8	1.14	19.0	14	16
	3.5	350	12.8	1.24	20.6	15	17
	4.0	400	12.8	1.32	22.1	16	19
6.0 ● Blue	1.7	170	11.6	1.01	16.8	15	17
	2.0	200	11.9	1.09	18.2	15	18
	2.5	250	12.2	1.22	20.4	16	19
	3.0	300	13.1	1.36	22.7	16	18
	3.5	350	13.1	1.47	24.5	17	20
	4.0	400	13.4	1.57	26.2	18	20
8.0 ● Blue	1.7	170	11.3	1.35	22.5	21	25
	2.0	200	11.9	1.46	24.3	21	24
	2.5	250	12.5	1.63	27.2	21	24
	3.0	300	13.4	1.81	30.2	20	23
	3.5	350	13.7	1.95	32.6	21	24
	4.0	400	14.0	2.09	34.8	21	25
4.5	450	14.0	2.22	36.9	23	26	

Note:

All precipitation rates are calculated for 180° operation. For the precipitation rate of a 360° sprinkler, divide by 2.

PGP ULTRA / I-20 / PRB GREY LOW-ANGLE NOZZLE PERFORMANCE DATA

Nozzle	Pressure		Radius m	Flow		Precip mm/hr	
	bar	kPa		m ³ /hr	l/min	■	▲
2.0 ● LA Grey	1.7	170	7.3	0.33	5.6	12	14
	2.0	200	7.6	0.36	6.0	12	14
	2.5	250	7.9	0.40	6.7	13	15
	3.0	300	8.2	0.45	7.4	13	15
	3.5	350	8.5	0.48	8.0	13	15
	4.0	400	8.8	0.52	8.6	13	15
2.5 ● LA Grey	1.7	170	7.9	0.44	7.3	14	16
	2.0	200	8.2	0.47	7.9	14	16
	2.5	250	8.8	0.53	8.8	14	16
	3.0	300	9.4	0.59	9.8	13	15
	3.5	350	10.1	0.64	10.6	13	15
	4.0	400	10.4	0.68	11.3	13	15
3.5 ● LA Grey	1.7	170	8.5	0.58	9.7	16	18
	2.0	200	8.8	0.62	10.3	16	18
	2.5	250	9.1	0.68	11.4	16	19
	3.0	300	10.1	0.75	12.5	15	17
	3.5	350	10.7	0.80	13.3	14	16
	4.0	400	11.0	0.85	14.1	14	16
4.5 ● LA Grey	1.7	170	8.2	0.71	11.8	21	24
	2.0	200	8.8	0.76	12.7	19	23
	2.5	250	9.1	0.84	14.1	20	23
	3.0	300	10.1	0.93	15.5	18	21
	3.5	350	10.7	1.00	16.6	18	20
	4.0	400	11.0	1.06	17.6	18	20
4.5	450	11.3	1.12	18.6	18	20	

PGP ULTRA / I-20 / PRB NOZZLES



Blue Standard / Grey Low-Angle (P/N 782900)

Flat-top nozzle for easy insertion coupled with a headed slotted adjustment screw for quick radius adjustment with a Hunter Wrench or a flat-blade screwdriver.



Pressure Regulation

Continual operating pressure of 3.1 bar; 310 kPa

I-20 04 with PRB Body



PR-075

Overall height: 5.7 cm
Inlet/outlet size: 3/4"
For use with all 3/4" inlet sprinklers models, regulates to 3.1 bar; 310 kPa

PGP ULTRA / I-20 GREEN HIGH-FLOW NOZZLE PERFORMANCE DATA

Nozzle	Pressure		Radius	Flow		Precip mm/hr	
	bar	kPa		m ³ /hr	l/min	■	▲
10 Dk. Green	1.7	170	10.7	1.48	24.6	26	30
	2.0	200	11.9	1.60	26.7	23	26
	2.5	250	12.5	1.80	30.0	23	27
	3.0	300	12.8	2.01	33.5	25	28
	3.5	350	13.1	2.18	36.3	25	29
	4.0	400	13.7	2.34	39.0	25	29
13 Dk. Green	1.7	170	11.0	1.91	31.9	32	37
	2.0	200	12.2	2.08	34.6	28	32
	2.5	250	12.8	2.34	38.9	29	33
	3.0	300	13.1	2.61	43.4	30	35
	3.5	350	13.4	2.83	47.1	31	36
	4.0	400	13.7	3.03	50.5	32	37
6.0 LA Dk. Green	1.7	170	9.1	0.86	14.3	21	24
	2.0	200	9.4	0.94	15.6	21	24
	2.5	250	10.1	1.07	17.8	21	24
	3.0	300	10.7	1.20	20.0	21	24
	3.5	350	11.3	1.31	21.9	21	24
	4.0	400	11.6	1.42	23.6	21	24
8.0 LA Dk. Green	1.7	170	10.1	1.17	19.5	23	27
	2.0	200	10.7	1.28	21.3	22	26
	2.5	250	11.3	1.44	24.0	23	26
	3.0	300	11.6	1.61	26.9	24	28
	3.5	350	11.9	1.76	29.3	25	29
	4.0	400	12.5	1.89	31.5	24	28
4.5	450	12.5	2.01	33.6	26	30	

PGP ULTRA / I-20 / PRB BLACK SHORT-RADIUS NOZZLE PERFORMANCE DATA

Nozzle	Pressure		Radius	Flow		Precip mm/hr	
	bar	kPa		m ³ /hr	l/min	■	▲
.50 SR Black	1.7	170	4.9	0.07	1.2	6	7
	2.0	200	5.2	0.08	1.3	6	7
	2.5	250	5.2	0.09	1.5	7	8
	3.0	300	5.2	0.10	1.7	8	9
	3.5	350	5.5	0.12	1.9	8	9
	4.0	400	5.5	0.13	2.1	8	10
1.0 SR Black	1.7	170	4.9	0.16	2.7	14	16
	2.0	200	5.2	0.17	2.9	13	15
	2.5	250	5.2	0.19	3.2	14	17
	3.0	300	5.2	0.21	3.6	16	18
	3.5	350	5.5	0.23	3.8	15	18
	4.0	400	5.5	0.25	4.1	16	19
2.0 SR Black	1.7	170	4.9	0.28	4.7	24	27
	2.0	200	5.2	0.31	5.2	23	27
	2.5	250	5.2	0.36	6.0	27	31
	3.0	300	5.2	0.41	6.9	31	35
	3.5	350	5.5	0.45	7.6	30	35
	4.0	400	5.5	0.49	8.2	33	38
.75 SR Black	1.7	170	6.7	0.12	2.0	5	6
	2.0	200	7.0	0.13	2.2	5	6
	2.5	250	7.0	0.15	2.4	6	7
	3.0	300	7.3	0.16	2.7	6	7
	3.5	350	7.6	0.17	2.9	6	7
	4.0	400	7.6	0.19	3.1	6	7
1.5 SR Black	1.7	170	6.7	0.23	3.8	10	12
	2.0	200	7.0	0.25	4.1	10	12
	2.5	250	7.0	0.28	4.6	11	13
	3.0	300	7.3	0.31	5.2	12	13
	3.5	350	7.6	0.34	5.6	12	13
	4.0	400	7.6	0.36	6.0	12	14
3.0 SR Black	1.7	170	6.7	0.53	8.9	24	27
	2.0	200	7.0	0.56	9.3	23	26
	2.5	250	7.0	0.60	10.0	24	28
	3.0	300	7.3	0.64	10.7	24	28
	3.5	350	7.6	0.67	11.2	23	27
	4.0	400	7.6	0.70	11.7	24	28
4.5	450	7.6	0.73	12.1	25	29	

PGP ULTRA / I-20 / PRB NOZZLES



Dk. Green High-Flow (P/N 444800)

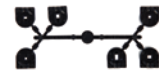

Black Short-Radius (P/N 466100)



I-20 with Blue Standard Nozzle







Note:

All precipitation rates are calculated for 180° operation. For the precipitation rate of a 360° sprinkler, divide by 2.

Convenient Nozzle Rack







PGP ULTRA / I-20 / PRB MPR-25 NOZZLE PERFORMANCE DATA

Nozzle	Pressure		Radius m	Flow		Precip mm/hr	
	bar	kPa		m ³ /hr	l/min	■	▲
90° 	1.7	170	7.0	0.17	3.0	13.7	15.8
	2.4	240	7.3	0.20	3.6	14.9	17.3
	3.1	310	7.6	0.23	3.6	15.6	18.1
	3.8	380	7.6	0.25	4.2	17.4	20.1
	4.5	450	7.6	0.27	4.8	18.9	21.9
120° 	1.7	170	7.0	0.23	3.6	13.9	16.0
	2.4	240	7.3	0.27	4.8	15.4	17.8
	3.1	310	7.6	0.31	5.4	16.2	18.7
	3.8	380	7.6	0.35	6.0	18.0	20.7
	4.5	450	7.6	0.38	6.6	19.6	22.6
180° 	1.7	170	7.0	0.33	5.4	13.3	15.4
	2.4	240	7.3	0.39	6.6	14.7	17.0
	3.1	310	7.6	0.45	7.2	15.5	17.9
	3.8	380	7.6	0.50	8.4	17.3	20.0
	4.5	450	7.6	0.55	9.0	18.9	21.8
360° 	1.7	170	7.0	0.63	10.8	12.8	14.8
	2.4	240	7.3	0.76	12.6	14.2	16.4
	3.1	310	7.6	0.87	14.4	14.9	17.3
	3.8	380	7.6	0.97	16.2	16.6	19.2
	4.5	450	7.6	1.05	17.4	18.1	20.9

MPR-25 NOZZLE







PGP ULTRA / I-20 / PRB MPR-35 NOZZLE PERFORMANCE DATA

Nozzle	Pressure		Radius m	Flow		Precip mm/hr	
	bar	kPa		m ³ /hr	l/min	■	▲
90° 	1.7	170	9.8	0.32	5.4	13.4	15.4
	2.4	240	10.4	0.38	6.6	14.1	16.3
	3.1	310	10.7	0.44	7.2	15.3	17.7
	3.8	380	10.7	0.48	7.8	17.0	19.6
	4.5	450	10.7	0.52	9.0	18.4	21.3
120° 	1.7	170	9.8	0.40	6.6	12.7	14.6
	2.4	240	10.4	0.49	8.4	13.6	15.8
	3.1	310	10.7	0.56	9.6	14.7	17.0
	3.8	380	10.7	0.62	10.2	16.4	18.9
	4.5	450	10.7	0.68	11.4	17.9	20.7
180° 	1.7	170	9.8	0.62	10.2	13.1	15.2
	2.4	240	10.4	0.76	12.6	14.1	16.3
	3.1	310	10.7	0.87	14.4	15.2	17.6
	3.8	380	10.7	0.96	16.2	16.9	19.5
	4.5	450	10.7	1.05	17.4	18.4	21.3
360° 	1.7	170	9.8	1.22	20.4	12.8	14.8
	2.4	240	10.4	1.50	25.2	14.0	16.2
	3.1	310	10.7	1.72	28.8	15.1	17.5
	3.8	380	10.7	1.91	31.8	16.8	19.4
	4.5	450	10.7	2.09	34.8	18.3	21.2



PGP ULTRA / I-20 / PRB MPR-30 NOZZLE PERFORMANCE DATA

Nozzle	Pressure		Radius m	Flow		Precip mm/hr	
	bar	kPa		m ³ /hr	l/min	■	▲
90° 	1.7	170	8.8	0.23	3.6	12.0	13.8
	2.4	240	9.1	0.28	4.8	13.4	15.4
	3.1	310	9.1	0.32	5.4	15.2	17.6
	3.8	380	9.1	0.35	6.0	17.0	19.6
	4.5	450	9.1	0.38	6.6	18.4	21.2
120° 	1.7	170	8.8	0.30	4.8	11.7	13.5
	2.4	240	9.1	0.37	6.0	13.2	15.2
	3.1	310	9.1	0.42	7.2	15.1	17.4
	3.8	380	9.1	0.47	7.8	16.8	19.4
	4.5	450	9.1	0.51	8.4	18.3	21.1
180° 	1.7	170	8.8	0.49	8.4	12.5	14.4
	2.4	240	9.1	0.59	9.6	14.1	16.2
	3.1	310	9.1	0.67	11.4	16.1	18.6
	3.8	380	9.1	0.75	12.6	17.9	20.7
	4.5	450	9.1	0.82	13.8	19.6	22.6
360° 	1.7	170	8.8	0.96	16.2	12.3	14.2
	2.4	240	9.1	1.15	19.2	13.8	15.9
	3.1	310	9.1	1.31	21.6	15.7	18.1
	3.8	380	9.1	1.45	24.0	17.4	20.0
	4.5	450	9.1	1.57	26.4	18.8	21.7

MPR-30 NOZZLE



PGP-04 Ultra with MPR-30 Nozzle



I-25

Radius: **11.9 to 21.6 m**
Flow: **0.82 to 7.24 m³/hr; 13.6 to 120.2 l/min**

The reliable, durable, and versatile I-25 Rotor offers an expansive nozzle selection that makes it the perfect choice for large turf applications.

KEY BENEFITS

- Patented automatic arc return feature returns the turret back to the original arc pattern if vandalised; adjustable arc from 50° to 360°
- Non-strippable drive mechanism is protected from damage if turned in the opposite direction of travel
- Part- and full-circle in one model for flexibility across landscapes and reduced inventory
- Colour-coded nozzles make identification easy
- Drain Check Valve prevents low-head drainage (up to 3 m of elevation)

OPERATING SPECIFICATIONS

- Nozzle choices: 11
- Radius: 11.9 to 21.6 m
- Flow: 0.82 to 7.24 m³/hr; 13.6 to 120.2 l/min
- Recommended pressure range: 2.5 to 7.0 bar; 250 to 700 kPa
- Warranty period: 5 years
- Operating pressure range: 2.5 to 7.0 bar; 250 to 700 kPa
- Precipitation rate: 15 mm/hr approximately
- Nozzle trajectory: standard = 25°

FACTORY-INSTALLED OPTIONS

- Reclaimed water ID
- High-speed rotation

USER-INSTALLED OPTIONS

- HSJ-1 prefabricated 1" (25 mm) PVC Swing Joint



I-25-04

Overall height: 20 cm
Pop-up height: 10 cm
Exposed diameter: 5 cm
Inlet size: 1" (25 mm) BSP



I-25-06

Overall height: 26 cm
Pop-up height: 15 cm
Exposed diameter: 5 cm
Inlet size: 1" (25 mm) BSP



I-25 Reclaimed

Available as a factory-installed option on all models



I-25 High-Speed

Available as a factory-installed option on all stainless steel models

I-25 (PLASTIC) - SPECIFICATION BUILDER: ORDER 1 + 2 + 3 + 4

1 Model	2 Standard Features	3 Feature Options	4 Nozzle Options
I-25-04 = 10 cm pop-up I-25-06 = 15 cm pop-up	Adjustable arc, plastic riser, check valve, and 5 nozzles	B = BSP inlet threads R = Reclaimed water ID	#4 - #28 = Factory-installed nozzle number

I-25 (STAINLESS STEEL) - SPECIFICATION BUILDER: ORDER 1 + 2 + 3 + 4

1 Model	2 Standard Features	3 Feature Options	4 Nozzle Options
I-25-04-SS = 10 cm pop-up I-25-06-SS = 15 cm pop-up	Adjustable arc, stainless steel riser, check valve, and 5 nozzles	B = BSP inlet threads R = Reclaimed water ID HS = High-speed HS-R = High-speed and reclaimed water ID	#4 - #28 = Factory-installed nozzle number

Examples:

- I-25-04-B = 10 cm pop-up, adjustable arc, BSP inlet threads
- I-25-04-SS-R-B-18 = 10 cm pop-up, adjustable arc, stainless steel riser, reclaimed water ID, and #18 nozzle, BSP inlet threads
- I-25-06-SS-B = 15 cm pop-up, adjustable arc, stainless steel riser, BSP inlet threads

I-25 STANDARD NOZZLE PERFORMANCE DATA

Nozzle	Pressure		Radius m	Flow		Precip mm/hr	
	bar	kPa		m ³ /hr	l/min	■	▲
4 ● Yellow	2.5	250	11.9	0.82	13.6	12	13
	3.0	300	12.2	0.91	15.2	12	14
	3.5	350	12.5	0.98	16.4	13	15
	4.0	400	12.5	1.05	17.5	13	16
	4.5	450	12.8	1.11	18.6	14	16
	5.0	500	13.1	1.18	19.6	14	16
7 ● Orange*	2.5	250	13.4	1.44	24.0	16	19
	3.0	300	14.0	1.54	25.6	16	18
	3.5	350	14.3	1.61	26.9	16	18
	4.0	400	14.3	1.68	28.0	16	19
	4.5	450	14.6	1.75	29.1	16	19
	5.0	500	14.9	1.81	30.1	16	19
8 ● Lt. Brown	2.5	250	14.0	1.65	27.5	17	19
	3.0	300	14.3	1.81	30.1	18	20
	3.5	350	14.9	1.94	32.3	17	20
	4.0	400	15.2	2.05	34.2	18	20
	4.5	450	15.2	2.16	36.0	19	22
	5.0	500	15.5	2.27	37.8	19	22
10 ● Lt. Green*	3.0	300	15.2	2.15	35.8	18	21
	3.5	350	15.5	2.32	38.6	19	22
	4.0	400	15.8	2.48	41.3	20	23
	4.5	450	16.2	2.63	43.9	20	23
	5.0	500	16.2	2.78	46.3	21	25
	5.5	550	16.5	2.94	48.9	22	25
13 ● Lt. Blue	3.0	300	15.8	2.38	39.6	19	22
	3.5	350	16.2	2.57	42.8	20	23
	4.0	400	16.5	2.75	45.7	20	23
	4.5	450	16.5	2.91	48.5	21	25
	5.0	500	16.8	3.04	51.2	22	25
	5.5	550	16.8	3.24	54.0	23	27

Nozzle	Pressure		Radius m	Flow		Precip mm/hr	
	bar	kPa		m ³ /hr	l/min	■	▲
15 ● Grey*	3.0	300	16.8	2.86	47.7	20	24
	3.5	350	17.1	3.05	50.8	21	24
	4.0	400	17.4	3.22	53.7	21	25
	4.5	450	17.4	3.38	56.3	22	26
	5.0	500	17.4	3.53	58.8	23	27
	5.5	550	17.7	3.69	61.5	24	27
	6.0	600	18.0	3.82	63.7	24	27
	6.2	620	18.3	3.88	64.6	23	27
18 ● Red	3.0	300	17.4	30.8	51.4	20	24
	3.5	350	17.7	3.31	55.2	21	24
	4.0	400	18.0	3.52	58.7	22	25
	4.5	450	18.3	3.72	62.0	22	26
	5.0	500	18.9	3.91	65.2	22	25
	5.5	550	19.2	4.11	68.5	22	26
	6.0	600	19.5	4.28	71.4	23	26
	6.2	620	19.5	4.35	72.5	23	26
20 ● Dk. Brown*	3.5	350	18.0	3.72	62.1	23	27
	4.0	400	18.6	3.97	66.2	23	27
	4.5	450	18.9	4.20	70.1	24	27
	5.0	500	19.2	4.42	73.7	24	28
	5.5	550	19.5	4.66	77.7	25	28
	6.0	600	19.8	4.86	81.0	25	29
	6.5	650	20.1	5.05	84.2	25	29
	6.9	690	20.4	5.21	86.8	25	29
23 ● Dk. Green	3.5	350	18.6	4.56	76.0	26	30
	4.0	400	19.2	4.88	81.3	26	31
	4.5	450	19.5	5.18	86.3	27	31
	5.0	500	19.8	5.47	91.1	28	32
	5.5	550	20.1	5.78	96.3	29	33
	6.0	600	20.1	6.04	100.6	30	34
	6.5	650	20.4	6.29	104.8	30	35
	6.9	690	20.7	6.50	108.3	30	35
25 ● Dk. Blue*	3.5	350	19.2	4.86	80.9	26	30
	4.0	400	19.8	5.23	87.1	27	31
	4.5	450	20.1	5.58	93.1	28	32
	5.0	500	20.4	5.92	98.7	28	33
	5.5	550	21.0	6.29	104.9	28	33
	6.0	600	21.0	6.60	110.0	30	34
	6.5	650	21.3	6.90	115.1	30	35
	6.9	690	21.6	7.15	119.2	31	35
28 ● Black	3.5	350	18.3	5.31	88.5	32	37
	4.0	400	19.2	5.63	93.8	31	35
	4.5	450	20.1	5.93	98.8	29	34
	5.0	500	20.7	6.21	103.5	29	33
	5.5	550	21.3	6.52	108.6	29	33
	6.0	600	21.3	6.77	112.8	30	34
	6.5	650	21.6	7.01	116.9	30	35
	6.9	690	21.6	7.21	120.2	31	36

* Five standard nozzles included with each sprinkler.

Note:

All precipitation rates are calculated for 180° operation. For the precipitation rate of a 360° sprinkler, divide by 2.

I-25 NOZZLE



I-25 HIGH-SPEED NOZZLE PERFORMANCE DATA							
Nozzle	Pressure		Radius m	Flow		Precip mm/hr	
	bar	kPa		m ³ /hr	l/min	■	▲
04 ● Yellow	2.5	250	11.0	0.81	13.6	14	16
	3.0	300	11.3	0.91	15.1	14	16
	3.5	350	11.6	0.99	16.4	15	17
	4.0	400	11.6	1.06	17.6	16	18
	4.5	450	11.6	1.13	18.8	17	19
	5.0	500	11.9	1.19	19.9	17	19
07 ● Orange*	2.5	250	11.9	1.32	22.0	19	22
	3.0	300	12.2	1.46	24.3	20	23
	3.5	350	12.5	1.57	26.2	20	23
	4.0	400	12.8	1.68	27.9	20	24
	4.5	450	13.1	1.78	29.6	21	24
	5.0	500	13.4	1.87	31.1	21	24
08 ● Lt. Brown	2.5	250	12.5	1.54	25.7	20	23
	3.0	300	12.8	1.72	28.6	21	24
	3.5	350	13.1	1.86	31.0	22	25
	4.0	400	13.4	2.00	33.3	22	26
	4.5	450	13.4	2.13	35.4	24	27
	5.0	500	13.7	2.25	37.5	24	28
10 ● Lt. Green*	3.0	300	13.7	2.15	35.8	23	26
	3.5	350	14.0	2.32	38.6	24	27
	4.0	400	14.3	2.48	41.3	24	28
	4.5	450	14.6	2.63	43.9	25	28
	5.0	500	14.9	2.78	46.3	25	29
	5.5	550	15.2	2.94	48.9	25	29
13 ● Lt. Blue	3.0	300	14.3	2.38	39.6	23	27
	3.5	350	14.6	2.57	42.8	24	28
	4.0	400	14.9	2.75	45.7	25	28
	4.5	450	15.2	2.91	48.5	25	29
	5.0	500	15.5	3.07	51.2	25	29
	5.5	550	15.5	3.24	54.0	27	31

Nozzle	Pressure		Radius m	Flow		Precip mm/hr	
	bar	kPa		m ³ /hr	l/min	■	▲
15 ● Grey*	3.0	300	14.6	2.86	47.7	27	31
	3.5	350	14.9	3.05	50.8	27	32
	4.0	400	15.2	3.22	53.7	28	32
	4.5	450	15.5	3.38	56.3	28	32
	5.0	500	16.2	3.53	58.8	27	31
	5.5	550	16.5	3.69	61.5	27	31
	6.0	600	16.5	3.82	63.7	28	33
	6.2	620	16.5	3.88	64.6	29	33
18 ● Red	3.0	300	14.9	3.08	51.4	28	32
	3.5	350	15.2	3.31	55.2	29	33
	4.0	400	15.5	3.52	58.7	29	34
	4.5	450	16.2	3.72	62.0	29	33
	5.0	500	16.8	3.91	65.2	28	32
	5.5	550	17.4	4.11	68.5	27	31
	6.0	600	17.4	4.28	71.4	28	33
	6.2	620	17.4	4.35	72.5	29	33
20 ● Dk. Brown*	3.5	350	15.5	3.72	62.1	31	36
	4.0	400	16.2	3.97	66.2	30	35
	4.5	450	16.5	4.20	70.1	31	36
	5.0	500	17.1	4.42	73.7	30	35
	5.5	550	17.7	4.66	77.7	30	34
	6.0	600	17.7	4.86	81.0	31	36
	6.5	650	18.0	5.05	84.2	31	36
	6.9	690	18.0	5.21	86.8	32	37
23 ● Dk. Green	3.5	350	16.5	4.56	76.0	34	39
	4.0	400	17.1	4.88	81.3	33	39
	4.5	450	17.4	5.18	86.3	34	40
	5.0	500	17.7	5.47	91.1	35	40
	5.5	550	18.3	5.78	96.3	35	40
	6.0	600	18.3	6.04	100.6	36	42
	6.5	650	18.6	6.29	104.8	36	42
	6.9	690	18.6	6.50	108.3	38	43
25 ● Dk. Blue*	3.5	350	17.1	4.86	80.9	33	38
	4.0	400	17.7	5.23	87.1	33	39
	4.5	450	18.3	5.58	93.1	33	39
	5.0	500	18.9	5.92	98.7	33	38
	5.5	550	19.5	6.29	104.9	33	38
	6.0	600	19.8	6.60	110.0	34	39
	6.5	650	20.1	6.90	115.1	34	39
	6.9	690	20.1	7.15	119.2	35	41
28 ● Black	3.5	350	17.4	5.31	88.5	35	41
	4.0	400	17.7	5.63	93.8	36	42
	4.5	450	18.0	5.93	98.8	37	42
	5.0	500	18.3	6.21	103.5	37	43
	5.5	550	18.9	6.52	108.6	36	42
	6.0	600	19.5	6.77	112.8	36	41
	6.5	650	19.8	7.01	116.9	36	41
	6.9	690	20.4	7.21	120.2	35	40

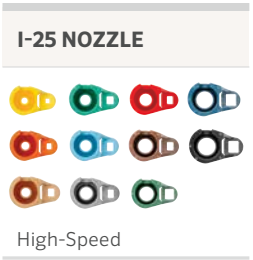

* 5 standard nozzles included with each sprinkler.

Notes:

All precipitation rates are calculated for 180° operation. For the precipitation rate of a 360° sprinkler, divide by 2.

I-40

Radius: **13.1 to 23.2 m**
Flow: **1.63 to 6.84 m³/hr; 27.2 to 114.1 l/min**

The I-40 Rotor has a comprehensive list of upgraded features that make it the top choice for demanding, large turf projects.

KEY BENEFITS

- Patented automatic arc return feature returns the turret back to the original arc pattern if vandalised; adjustable arc from 50° to 360°
- Non-strippable drive mechanism is protected from damage if turned in the opposite direction of travel
- Part- and full-circle in one model for flexibility across landscapes and reduced inventory
- Colour-coded nozzles make identification easy
- Available opposing nozzle model for even watering in full-circle applications (I-40-ON model)
- Drain Check Valve prevents low-head drainage (up to 4.5 m of elevation)

OPERATING SPECIFICATIONS

- Nozzle choices: 12
- Radius I-40: 13.1 to 21.3 m
- Radius I-40-ON: 15.2 to 23.2 m
- Flow I-40: 1.63 to 6.84 m³/hr; 27.2 to 114.1 l/min
- Flow I-40-ON: 2.75 to 7.76 m³/hr; 45.8 to 129.4 l/min
- Warranty period: 5 years
- Recommended pressure range: 2.5 to 7.0 bar; 250 to 700 kPa
- Operating pressure range: 2.5 to 7.0 bar; 250 to 700 kPa
- Precipitation rates: 15 mm/hr approximately
- Nozzle trajectory: standard = 25°

FACTORY-INSTALLED OPTIONS

- Reclaimed water ID
- High-speed rotation

USER-INSTALLED OPTIONS

- HSJ-1 prefabricated 1" (25 mm) PVC Swing Joint



I-40-04

Overall height: 20 cm
Pop-up height: 10 cm
Exposed diameter: 5 cm
Inlet size: 1" (25 mm) BSP



I-40-06

Overall height: 26 cm
Pop-up height: 15 cm
Exposed diameter: 5 cm
Inlet size: 1" (25 mm) BSP



I-40 Reclaimed

Available as a factory-installed option on all models



I-40 High-Speed

Available as a factory-installed option on all models

I-40 - SPECIFICATION BUILDER: ORDER 1 + 2 + 3 + 4

1 Model	2 Standard Features	3 Feature Options	4 Nozzle Options
I-40-04-SS = 10 cm pop-up I-40-06-SS = 15 cm pop-up	Adjustable arc, stainless steel riser, check valve, and 6 nozzles	B = BSP inlet threads R = Reclaimed water ID HS = High-speed HS-R = High-speed and reclaimed water ID	#8 to #25 = Factory-installed nozzle number

I-40-ON - SPECIFICATION BUILDER: ORDER 1 + 2 + 3 + 4

1 Model	2 Standard Features	3 Feature Options	4 Nozzle Options
I-40-04-SS-ON = 10 cm pop-up I-40-06-SS-ON = 15 cm pop-up	Full-circle, opposing nozzle, stainless steel riser, check valve, and 6 nozzles	B = BSP inlet threads R = Reclaimed water ID ON = Full-circle opposing nozzle ON-R = Full circle opposing nozzles, reclaimed water ID	#15 to #28 = Factory-installed nozzle number

Examples:

I-40-04-SS-B = 10 cm pop-up, BSP inlet threads

I-40-04-SS-ON-R-B-23 = 10 cm pop-up, full-circle opposing nozzles, reclaimed water ID, #23 nozzle, BSP inlet threads

I-40-06-SS-15-B = 15 cm pop-up, #15 nozzle, BSP inlet threads

I-40 STANDARD NOZZLE PERFORMANCE DATA

Nozzle	Pressure		Radius m	Flow		Precip mm/hr	
	bar	kPa		m ³ /hr	l/min	■	▲
08 Lt. Brown	2.5	250	13.1	1.63	27.2	19	22
	3.0	300	13.4	1.80	30.0	20	23
	3.5	350	13.7	1.94	32.3	21	24
	4.0	400	14.0	2.06	34.4	21	24
	4.5	450	14.0	2.18	36.3	22	26
	5.0	500	14.3	2.29	38.2	22	26
10 Lt. Green	3.0	300	14.6	2.20	36.6	21	24
	3.5	350	14.9	2.37	39.4	21	24
	4.0	400	15.2	2.52	42.0	22	25
	4.5	450	15.5	2.67	44.5	22	25
	5.0	500	15.5	2.81	46.8	23	27
	5.5	550	15.8	2.96	49.3	24	27
13 Lt. Blue	3.0	300	14.9	2.36	39.4	21	24
	3.5	350	15.2	2.55	42.6	22	25
	4.0	400	15.5	2.73	45.5	23	26
	4.5	450	15.5	2.90	48.3	24	28
	5.0	500	15.8	3.06	51.0	24	28
	5.5	550	16.2	3.23	53.9	25	29
15 Grey	3.0	300	16.2	2.93	48.8	22	26
	3.5	350	16.5	3.19	53.2	24	27
	4.0	400	16.8	3.44	57.3	24	28
	4.5	450	17.1	3.67	61.2	25	29
	5.0	500	17.4	3.89	64.9	26	30
	5.5	550	18.0	4.14	68.9	26	30
23 Dk. Green	3.5	350	18.6	4.48	74.6	26	30
	4.0	400	18.9	4.76	79.4	27	31
	4.5	450	19.2	5.03	83.9	27	32
	5.0	500	19.5	5.29	88.1	28	32
	5.5	550	19.8	5.56	92.7	28	33
	6.0	600	20.1	5.79	96.5	29	33
25 Dk. Blue	3.5	350	19.8	4.98	83.0	25	29
	4.0	400	20.1	5.33	88.7	26	30
	4.5	450	20.4	5.65	94.2	27	31
	5.0	500	20.7	5.96	99.3	28	32
	5.5	550	21.0	6.29	104.9	28	33
	6.0	600	21.0	6.57	109.6	30	34

I-40 HIGH-SPEED NOZZLE PERFORMANCE DATA

Nozzle	Pressure		Radius m	Flow		Precip mm/hr	
	bar	kPa		m ³ /hr	l/min	■	▲
08 Lt. Brown	2.5	250	12.2	1.63	27.2	22	25
	3.0	300	12.5	1.80	30.0	23	27
	3.5	350	12.8	1.94	32.3	24	27
	4.0	400	12.8	2.06	34.4	25	29
	4.5	450	13.1	2.18	36.3	25	29
	5.0	500	13.4	2.29	38.2	25	29
10 Lt. Green	3.0	300	13.4	2.20	36.6	34	28
	3.5	350	13.7	2.37	39.4	25	29
	4.0	400	14.0	2.52	42.0	26	30
	4.5	450	14.0	2.67	44.5	27	31
	5.0	500	14.3	2.81	46.8	27	32
	5.5	550	14.6	2.96	49.3	28	32
13 Lt. Blue	3.0	300	13.7	2.36	39.4	25	29
	3.5	350	14.0	2.55	42.6	26	30
	4.0	400	14.3	2.73	45.5	27	31
	4.5	450	14.3	2.90	48.3	28	33
	5.0	500	14.6	3.06	51.0	29	33
	5.5	550	14.9	3.23	53.9	29	33
15 Grey	3.0	300	15.2	2.93	48.8	25	29
	3.5	350	15.5	3.19	53.2	26	30
	4.0	400	15.8	3.44	57.3	27	32
	4.5	450	15.8	3.67	61.2	29	34
	5.0	500	16.2	3.89	64.9	30	34
	5.5	550	16.5	4.14	68.9	31	35
23 Dk. Green	3.5	350	16.8	4.48	74.6	32	37
	4.0	400	17.4	4.76	79.4	32	36
	4.5	450	17.7	5.03	83.9	32	37
	5.0	500	17.7	5.29	88.1	34	39
	5.5	550	18.0	5.56	92.7	34	40
	6.0	600	18.3	5.79	96.5	35	40
25 Dk. Blue	3.5	350	17.4	4.98	83.0	33	38
	4.0	400	18.0	5.33	88.7	33	38
	4.5	450	18.3	5.65	94.2	34	39
	5.0	500	18.6	5.96	99.3	34	40
	5.5	550	18.9	6.29	104.9	35	41
	6.0	600	19.2	6.57	109.6	36	41

I-40 NOZZLES



Standard/
High-Speed



Note:

All precipitation rates are calculated for 180° operation. For the precipitation rate of a 360° sprinkler, divide by 2.

I-40 DUAL OPPOSING NOZZLE PERFORMANCE DATA

Nozzle	Pressure		Radius m	Flow		Precip mm/hr	
	bar	kPa		m ³ /hr	l/min	■	▲
15 ● Grey	3.0	300	15.2	2.75	45.8	12	14
	3.5	350	15.8	2.91	48.5	12	13
	4.0	400	16.2	3.06	51.0	12	14
	4.5	450	16.8	3.20	53.3	11	13
	5.0	500	17.1	3.32	55.4	11	13
	5.5	550	17.4	3.46	57.7	11	13
	6.0	600	17.7	3.58	59.6	11	13
18 ● Red	3.0	300	17.4	2.90	48.3	10	11
	3.5	350	17.7	3.15	52.5	10	12
	4.0	400	18.0	3.38	56.4	10	12
	4.5	450	18.0	3.61	60.1	11	13
	5.0	500	18.3	3.82	63.7	11	13
	5.5	550	18.9	4.05	67.5	11	13
	6.0	600	19.2	4.25	70.8	12	13
20 ● Dk. Brown	3.5	350	18.3	3.98	66.2	12	14
	4.0	400	18.9	4.26	71.1	12	14
	4.5	450	19.2	4.54	75.6	12	14
	5.0	500	19.5	4.80	80.0	13	15
	5.5	550	20.1	5.08	84.7	13	15
	6.0	600	19.8	5.32	88.7	14	16
	6.2	620	19.8	5.42	90.4	14	16
23 ● Dk. Green	3.5	350	18.9	4.23	70.6	12	14
	4.0	400	19.5	4.55	75.8	12	14
	4.5	450	19.8	4.85	80.8	12	14
	5.0	500	20.1	5.14	85.6	13	15
	5.5	550	20.4	5.45	90.8	13	15
	6.0	600	20.7	5.71	95.1	13	15
	6.2	620	20.7	5.82	97.0	14	16
25 ● Dk. Blue	3.5	350	19.5	4.60	76.7	12	14
	4.0	400	20.1	4.92	82.1	12	14
	4.5	450	20.4	5.23	87.2	13	14
	5.0	500	20.7	5.52	92.0	13	15
	5.5	550	21.0	5.84	97.3	13	15
	6.0	600	21.3	6.10	101.7	13	15
	6.2	620	21.3	6.22	103.6	14	16
28 ● Black	3.5	350	19.8	5.73	95.5	15	17
	4.0	400	20.4	6.07	101.1	15	17
	4.5	450	21.0	6.38	106.4	14	17
	5.0	500	21.3	6.68	111.3	15	17
	5.5	550	21.9	7.00	116.7	15	17
	6.0	600	22.3	7.27	121.1	15	17
	6.2	620	22.3	7.38	122.9	15	17
6.5	650	22.6	7.52	125.3	15	17	
6.9	690	23.2	7.73	128.8	14	17	

Note:
Precipitation rates for the ON-Opposing Nozzles models are calculated at 360°.

I-40 NOZZLES



Opposing

Front

Back



I-40 Turf Cup Kit Option

Available as a field-installed option on all models
P/N TURFCUPKITI40

I-40 Opposing Nozzle 360° Model



I-50

Radius: **13.1 to 23.2 m**
Flow: **1.63 to 6.84 m³/hr; 27.2 to 114.1 l/min**

The high-torque I-50 Rotor is engineered to thrive in difficult water-quality conditions within large turf projects.

KEY BENEFITS

- Extra-strong, non-strippable, planetary gear drive mechanism is reliable and durable in harsh water conditions
- Tool-free, part- and full-circle arc adjustment mechanism makes fast, easy installation and reduces inventory (60° to 360°)
- Colour-coded nozzles make identification easy
- Available opposing nozzle model for even watering in full-circle applications (I-50-ON model)
- Drain Check Valve prevents low-head drainage (up to 4.5 m of elevation)

OPERATING SPECIFICATIONS

- Nozzle choices: 12
- Radius I-50: 13.1 to 21.3 m
- Radius I-50-ON: 15.2 to 23.2 m
- Flow I-50: 1.63 to 6.84 m³/hr; 27.2 to 114.1 l/min
- Flow I-50-ON: 2.75 to 7.76 m³/hr; 45.8 to 129.4 l/min
- Recommended pressure range: 2.5 to 7.0 bar; 250 to 700 kPa
- Operating pressure range: 2.5 to 7.0 bar; 250 to 700 kPa
- Precipitation rate: 15 mm/hr approximately
- Nozzle trajectory: standard = 25°
- Warranty period: 5 years

FACTORY-INSTALLED OPTIONS

- Reclaimed water ID

USER-INSTALLED OPTIONS

- HSJ-1 prefabricated 1" (25 mm) PVC Swing Joint



I-50 Reclaimed
Available as a factory-installed option on all models



I-50-06-SS
Overall height: 26 cm
Pop-up height: 15 cm
Exposed diameter: 5 cm
Inlet size: 1" (25 mm) BSP



I-50-06-SS-ON
Overall height: 26 cm
Pop-up height: 15 cm
Exposed diameter: 5 cm
Inlet size: 1" (25 mm) BSP



I-50 Turf Cup Kit Option
Available as a field-installed option on all models
P/N TURFCUPKITI40

Below-the-turret arc adjustment



Robust planetary gear drive for extreme conditions

I-50 - SPECIFICATION BUILDER: ORDER 1 + 2 + 3 + 4

1 Model	2 Standard Features	3 Feature Options	4 Nozzle Options
I-50-06-SS = 15 cm pop-up	Adjustable arc, stainless steel riser, check valve, and 6 nozzles	B = BSP inlet threads R = Reclaimed water ID	#8 to #25 = Factory-installed nozzle number

I-50-ON - SPECIFICATION BUILDER: ORDER 1 + 2 + 3 + 4

1 Model	2 Standard Features	3 Feature Options	4 Nozzle Options
I-50-06-SS-ON = 15 cm pop-up	Full-circle, opposing nozzle, stainless steel riser, check valve, and 6 nozzles	B = BSP inlet threads R = Reclaimed water ID	#15 to #28 = Factory-installed nozzle number

Examples:

- I-50-06-SS-B = 15 cm pop-up, BSP inlet threads
- I-50-06-SS-ON-R-B-23 = 15 cm pop-up, full-circle opposing nozzles, reclaimed water ID, #23 nozzle, BSP inlet threads
- I-50-06-SS-15-B = 15 cm Pop-up, #15 nozzle, BSP inlet threads

I-50 STANDARD NOZZLE PERFORMANCE DATA							
Nozzle	Pressure		Radius	Flow		Precip mm/hr	
	bar	kPa		m ³ /hr	l/min	■	▲
08 ● Lt. Brown	2.5	250	13.1	1.63	27.2	19	22
	3.0	300	13.4	1.80	30.0	20	23
	3.5	350	13.7	1.94	32.3	21	24
	4.0	400	14.0	2.06	34.4	21	24
	4.5	450	14.0	2.18	36.3	22	26
	5.0	500	14.3	2.29	38.2	22	26
10 ● Lt. Green	3.0	300	14.6	2.20	36.6	21	24
	3.5	350	14.9	2.37	39.4	21	24
	4.0	400	15.2	2.52	42.0	22	25
	4.5	450	15.5	2.67	44.5	22	25
	5.0	500	15.5	2.81	46.8	23	27
	5.5	550	15.8	2.96	49.3	24	27
13 ● Lt. Blue	3.0	300	14.9	2.36	39.4	21	24
	3.5	350	15.2	2.55	42.6	22	25
	4.0	400	15.5	2.73	45.5	23	26
	4.5	450	15.5	2.90	48.3	24	28
	5.0	500	15.8	3.06	51.0	24	28
	5.5	550	16.2	3.23	53.9	25	29
15 ● Grey	3.0	300	16.2	2.93	48.8	22	26
	3.5	350	16.5	3.19	53.2	24	27
	4.0	400	16.8	3.44	57.3	24	28
	4.5	450	17.1	3.67	61.2	25	29
	5.0	500	17.4	3.89	64.9	26	30
	5.5	550	18.0	4.14	68.9	26	30
23 ● Dk. Green	3.0	300	18.3	4.34	72.4	26	30
	3.5	350	18.6	4.48	74.6	26	30
	4.0	400	18.9	4.76	79.4	27	31
	4.5	450	19.2	5.03	83.9	27	32
	5.0	500	19.5	5.29	88.1	28	32
	5.5	550	19.8	5.56	92.7	28	33
25 ● Dk. Blue	3.0	300	20.1	5.79	96.5	29	33
	3.5	350	20.4	6.19	103.2	30	34
	4.0	400	20.1	5.33	88.7	26	30
	4.5	450	20.4	5.65	94.2	27	31
	5.0	500	20.7	5.96	99.3	28	32
	5.5	550	21.0	6.29	104.9	28	33
28 ● Black	6.0	600	21.0	6.57	109.6	30	34
	6.2	620	21.0	6.69	111.5	30	35
	6.5	650	21.3	6.84	114.1	30	35
	6.9	690	21.3	7.07	117.8	31	36

Note:

All precipitation rates are calculated for 180° operation. For the precipitation rate of a 360° sprinkler, divide by 2.

I-50 Opposing Nozzle 360° Model



I-50 DUAL OPPOSING NOZZLE PERFORMANCE DATA							
Nozzle	Pressure		Radius	Flow		Precip mm/hr	
	bar	kPa		m ³ /hr	l/min	■	▲
15 ● Grey	3.0	300	15.2	2.75	45.8	12	14
	3.5	350	15.8	2.91	48.5	12	13
	4.0	400	16.2	3.06	51.0	12	14
	4.5	450	16.8	3.20	53.3	11	13
	5.0	500	17.1	3.32	55.4	11	13
	5.5	550	17.4	3.46	57.7	11	13
18 ● Red	6.0	600	17.7	3.58	59.6	11	13
	6.2	620	17.7	3.62	60.4	12	13
	3.0	300	17.4	2.90	48.3	10	11
	3.5	350	17.7	3.15	52.5	10	12
	4.0	400	18.0	3.38	56.4	10	12
	4.5	450	18.0	3.61	60.1	11	13
20 ● Dk. Brown	5.0	500	18.3	3.82	63.7	11	13
	5.5	550	18.9	4.05	67.5	11	13
	6.0	600	19.2	4.25	70.8	12	13
	6.2	620	19.2	4.33	72.1	12	14
	6.5	650	19.5	4.43	73.9	12	13
	3.5	350	18.3	3.98	66.2	12	14
23 ● Dk. Green	4.0	400	18.9	4.26	71.1	12	14
	4.5	450	19.2	4.54	75.6	12	14
	5.0	500	19.5	4.80	80.0	13	15
	5.5	550	20.1	5.08	84.7	13	15
	6.0	600	19.8	5.32	88.7	14	16
	6.2	620	19.8	5.42	90.4	14	16
25 ● Dk. Blue	6.5	650	20.1	5.55	92.5	14	16
	6.9	690	20.1	5.74	95.7	14	16
	3.5	350	18.9	4.23	70.6	12	14
	4.0	400	19.5	4.55	75.8	12	14
	4.5	450	19.8	4.85	80.8	12	14
	5.0	500	20.1	5.14	85.6	13	15
28 ● Black	5.5	550	20.4	5.45	90.8	13	15
	6.0	600	20.7	5.71	95.1	13	15
	6.2	620	20.7	5.82	97.0	14	16
	6.5	650	20.7	5.96	99.4	14	16
	6.9	690	21.0	6.17	102.9	14	16
	3.5	350	19.5	4.60	76.7	12	14
28 ● Black	4.0	400	20.1	4.92	82.1	12	14
	4.5	450	20.4	5.23	87.2	13	14
	5.0	500	20.7	5.52	92.0	13	15
	5.5	550	21.0	5.84	97.3	13	15
	6.0	600	21.3	6.10	101.7	13	15
	6.2	620	21.3	6.22	103.6	14	16
28 ● Black	6.5	650	21.3	6.36	106.0	14	16
	6.9	690	21.6	6.57	109.5	14	16
	3.5	350	19.8	5.73	95.5	15	17
	4.0	400	20.4	6.07	101.1	15	17
	4.5	450	21.0	6.38	106.4	14	17
	5.0	500	21.3	6.68	111.3	15	17
28 ● Black	5.5	550	21.9	7.00	116.7	15	17
	6.0	600	22.3	7.27	121.1	15	17
	6.2	620	22.3	7.38	122.9	15	17
	6.5	650	22.6	7.52	125.3	15	17
	6.9	690	23.2	7.73	128.8	14	17

Note:

Precipitation rates for the ON-Opposing Nozzles models are calculated at 360°.

I-50 STANDARD NOZZLES



Front



I-50 OPPOSING NOZZLES



Front and Back



I-80

Radius: **19.2 to 29.6 m**
 Flow: **4.59 to 13.5 m³/hr;**
76.5 to 225.6 l/min

The highly versatile and efficient I-80 Rotor is the first commercial sports turf rotor with no-dig Total-Top-Serviceability.

KEY BENEFITS

- Exclusive Total-Top-Service (TTS) design provides convenient no-dig servicing
- PressurePort™ Technology and forward-facing triple nozzles (I-80) or opposing triple nozzles (I-80-ON) create exceptional nozzle uniformity in part- and full-circle applications
- Tool-free, part- and full-circle arc adjustment mechanism makes fast, easy installation and reduces inventory (70° to 360°)
- Ratcheting stainless steel riser allows setting of right-side fixed arc alignment to the landscape without rotor disassembly

OPERATING SPECIFICATIONS

- I-80 nozzle choices: 7 standard
- I-80-ON nozzle choices: 7 standard
- Radius I-80: 19.8 to 28.7 m
- Radius I-80-ON: 19.2 to 29.6 m
- Flow I-80: 4.6 to 13.5 m³/hr; 76.5 to 225.6 l/min
- Flow I-80-ON: 4.9 to 13.3 m³/hr; 81.8 to 221.4 l/min
- Recommended pressure range: 3.4 to 6.9 bar; 340 to 690 kPa
- Operating pressure range: 2.7 to 10.3 bar; 275 to 1030 kPa
- Precipitation rates: 10 mm/hr approximately
- Warranty period: 5 years

FACTORY-INSTALLED OPTIONS

- Exclusive Turf Cup option for an aesthetically clean and safe installation
- Reclaimed water ID

USER-INSTALLED OPTIONS

- Rubber Cover Kit #959300SP
- Turf Cup Kit #959400SP
- HSJ prefabricated PVC Swing Joints



I-80-04-SS Pop-Up
I-80-04-SS-ON Pop-Up
 Overall height: 25 cm
 Pop-up height: 9.5 cm
 Exposed diameter: 11 cm
 Inlet size: 1½" (40 mm)



I-80-04-SS-TC Turf Cup
I-80-04-SS-ON-TC Turf Cup
 Overall height: 29 cm
 Pop-up height: 9.5 cm
 Exposed diameter: 8.9 cm
 Inlet size: 1½" (40 mm)



I-80 Turf Cup Kit
 P/N 959400SP



I-80 Rubber Cover Kit
 P/N 959300SP

I-80 - SPECIFICATION BUILDER: ORDER 1 + 2 + 3 + 4

1 Model	2 Standard Features	3 Featured Options	4 Nozzle Options
I-80-04-SS = 10 cm pop-up I-80-04-SS-TC = 10 cm pop-up with turf cup	Adjustable arc, stainless steel riser, check valve Adjustable arc, stainless steel riser, check valve, factory-installed turf cup	R = Reclaimed water ID* B = BSP inlet threads * TC reclaimed ID not available	#23 to #53 = Factory-installed nozzle number, no nozzle pack
I-80-04-SS-ON = 10 cm pop-up I-80-04-SS-ON-TC = 10 cm pop-up with turf cup	Full-circle, opposing nozzle, stainless steel riser, check valve Full-circle, opposing nozzle, stainless steel riser, check valve, factory-installed turf cup	R = Reclaimed water ID* B = BSP inlet threads * TC reclaimed ID not available	#23 to #53 = Factory-installed nozzle number, no nozzle pack

Examples:

- I-80-04-SS-B-25 = 10 cm pop-up, adjustable arc, stainless steel riser, check valve, BSP inlet threads, and factory-installed #25 nozzle
- I-80-04-SS-ON-R-B-38 = 10 cm pop-up, stainless steel riser, check valve, opposing nozzle full-circle, reclaimed water ID, BSP inlet threads, and factory-installed #38 nozzle
- I-80-04-SS-ON-TC-B-48 = 10 cm pop-up, stainless steel riser, check valve, opposing nozzle full-circle, factory-installed turf cup, BSP inlet threads, and factory-installed #48 nozzle

I-80-ON NOZZLE PERFORMANCE DATA*											
Nozzle Set			Pressure		Radius	Flow		Precip mm/hr			
			bar	kPa	m	m ³ /hr	l/min	■	▲		
● Tan 803611	● Green 23	● Lt. Blue 315311	3.4	344	19.2	4.91	81.8	13.3	15.4		
			4.1	413	19.8	5.22	87.1	13.3	15.4		
			4.5	450	20.1	5.45	90.8	13.5	15.6		
			4.8	482	20.4	5.66	94.3	13.6	15.7		
			5.5	551	20.7	6.04	100.7	14.1	16.2		
● Tan 803611	● Blue 25	● Lt. Blue 315311	4.5	450	21.6	6.50	108.3	13.9	16.0		
			4.8	482	22.3	6.75	112.5	13.6	15.7		
			5.5	551	22.6	7.19	119.8	14.1	16.3		
			6.2	620	22.9	7.65	127.5	14.6	16.9		
			6.9	689	23.5	8.12	135.3	14.7	17.0		
● Tan 803611	● Grey 33	● Lt. Blue 315311	4.5	450	22.6	7.02	117.0	13.8	15.9		
			4.8	482	22.9	7.27	121.1	13.9	16.1		
			5.5	551	23.5	7.77	129.5	14.1	16.3		
			6.2	620	24.1	8.22	137.0	14.2	16.4		
			6.9	689	24.7	8.68	144.6	14.2	16.4		
● Tan 803611	● Red 38	● Lt. Blue 315311	4.5	450	23.5	7.97	132.9	14.5	16.7		
			4.8	482	24.1	8.31	138.5	14.3	16.6		
			5.5	551	25.0	8.84	147.3	14.1	16.3		
			6.2	620	25.6	9.38	156.3	14.3	16.5		
			6.9	689	26.5	9.90	165.0	14.1	16.3		
● Tan 803611	● Dk. Brown 43	● Lt. Blue 315311	-	-	-	-	-	-	-		
			4.8	482	25.3	9.38	156.3	14.7	16.9		
			5.5	551	25.9	9.90	165.0	14.8	17.0		
			6.2	620	26.5	10.52	175.3	15.0	17.3		
			6.9	689	27.1	11.09	184.7	15.1	17.4		
● Tan 803611	● Dk. Green 48	● Lt. Blue 315311	-	-	-	-	-	-	-		
			4.8	482	27.4	10.65	177.5	14.2	16.3		
			5.5	551	28.0	11.11	185.1	14.1	16.3		
			6.2	620	28.7	11.46	191.0	14.0	16.1		
			6.9	689	29.3	12.15	202.5	14.2	16.4		
● Tan 803611	● Dk. Blue 53	● Lt. Blue 315311	-	-	-	-	-	-	-		
			4.8	482	27.7	11.31	188.5	14.7	17.0		
			5.5	551	28.3	11.86	197.7	14.8	17.0		
			6.2	620	29.0	12.61	210.1	15.0	17.4		
			6.9	689	29.6	13.29	221.4	15.2	17.6		



I-80 NOZZLE PERFORMANCE DATA											
Nozzle Set			Pressure		Radius	Flow		Precip mm/hr			
			bar	kPa	m	m ³ /hr	l/min	■	▲		
● Orange 803603	● Green 23	● Lt. Green 315313	3.4	344	19.8	4.59	76.5	11.7	13.5		
			4.1	413	20.1	5.02	83.7	12.4	14.3		
			4.5	450	20.4	5.43	90.5	13.0	15.0		
			4.8	482	20.4	5.50	91.6	13.2	15.2		
			5.5	551	21.0	5.88	98.0	13.3	15.4		
● Orange 803603	● Blue 25	● Lt. Green 315313	4.5	450	21.6	6.43	107.1	13.7	15.8		
			4.8	482	21.9	6.66	110.9	13.8	16.0		
			5.5	551	22.3	7.16	119.2	14.5	16.7		
			6.2	620	22.6	7.59	126.4	14.9	17.2		
			6.9	689	22.9	8.04	134.0	15.4	17.8		
● Orange 803603	● Grey 33	● Lt. Green 315313	4.5	450	21.9	6.95	115.8	14.4	16.7		
			4.8	482	22.3	7.18	119.6	14.5	16.7		
			5.5	551	22.9	7.70	128.3	14.7	17.0		
			6.2	620	23.5	8.13	135.5	14.8	17.0		
			6.9	689	24.1	8.61	143.5	14.8	17.1		
● Orange 803603	● Red 38	● Lt. Green 315313	4.5	450	23.2	7.93	132.1	14.8	17.1		
			4.8	482	23.8	8.22	137.0	14.5	16.8		
			5.5	551	24.4	8.88	148.0	14.9	17.2		
			6.2	620	25.0	9.36	156.0	15.0	17.3		
			6.9	689	25.6	9.88	164.7	15.1	17.4		
● Orange 803603	● Dk. Brown 43	● Lt. Green 315313	-	-	-	-	-	-	-		
			4.8	482	24.7	9.36	156.0	15.4	17.7		
			5.5	551	25.3	9.88	164.7	15.4	17.8		
			6.2	620	26.2	10.49	174.9	15.3	17.6		
			6.9	689	27.1	11.06	184.3	15.0	17.4		
● Orange 803603	● Dk. Green 48	● Lt. Green 315313	-	-	-	-	-	-	-		
			4.8	482	25.3	10.52	175.3	16.4	19.0		
			5.5	551	25.9	10.99	183.2	16.4	18.9		
			6.2	620	27.1	11.74	195.7	16.0	18.4		
			6.9	689	27.7	12.38	206.3	16.1	18.6		
● Orange 803603	● Dk. Blue 53	● Lt. Green 315313	-	-	-	-	-	-	-		
			4.8	482	26.5	11.52	191.9	16.4	18.9		
			5.5	551	27.1	12.06	201.0	16.4	18.9		
			6.2	620	28.0	12.81	213.5	16.3	18.8		
			6.9	689	28.7	13.54	225.6	16.5	19.0		

● = Nozzle Plug P/N 315300 installed in the back side of the nozzle housing.
 * Complies to ASAE standard. All precipitation rates calculated for 360° operation. All triangular rates are equilateral.

I-90

Radius: **22.3 to 31.4 m**
Flow: **6.7 to 19.04 m³/hr; 111.7 to 317.2 l/min**

The robust I-90 Rotor is built for long-distance natural turf applications in large parks, open spaces, and sports fields.

KEY BENEFITS

- PressurePort™ Technology, forward-facing triple nozzles (I-90), opposing triple nozzles (I-90-ON) create exceptional nozzle uniformity in part- and full-circle applications
- Part- and full-circle in one model provides flexible installation options and reduces inventory (I-90)
- Drain Check Valve prevents low-head drainage (up to 2 m of elevation)

OPERATING SPECIFICATIONS

- I-90 nozzle choices: 8
- Radius I-90 ADV: 20.1 to 29.6 m
- Radius I-90 36V: 22.3 to 31.4 m
- Flow I-90 ADV: 6.7 to 19.04 m³/hr; 111.7
- Flow I-90 36V: 6.93 to 18.92 m³/hr; 115.5 to 315.3 l/min
- Recommended pressure range: 5.5 to 8.3 bar; 550 to 830 kPa
- Operating pressure range: 5.5 to 8.3 bar; 550 to 1030 kPa
- Precipitation rate: 19 mm/hr approximately
- Warranty period: 5 years

FACTORY-INSTALLED OPTIONS

- Reclaimed water ID

USER-INSTALLED OPTIONS

- Rubber Cover Kit #234201
- Turf Cup Kit #467955
- HSJ prefabricated PVC 1½" (40 mm) Swing Joints



I-90
Overall height:
ADV/36V: 28 cm
Pop-up height: 8 cm
Exposed diameter: 9 cm
Inlet size: 1½" (40 mm) BSP



Turf Cup Kit
P/N 467955



Rubber Cover Kits
I90-ADV: P/N 234200
I90-36V: P/N 234201



I-90 Reclaimed
Available as a factory-installed option on all models

I-90 - SPECIFICATION BUILDER: ORDER 1 + 2 + 3 + 4

1 Model	2 Standard Features	3 Feature Options	4 Nozzle Options
I-90 = 8 cm pop-up	Plastic riser, check valve, and 8 standard trajectory nozzles	ADV = Adjustable arc ARV = Adjustable arc and reclaimed water ID 36V = Full-circle, opposing nozzles 3RV = Full-circle, opposing nozzles and reclaimed water ID B = BSP inlet threads	#25 to #73 = Factory-installed nozzle number

Examples:

- I-90-ADV-B = 8 cm pop-up, adjustable arc, with BSP inlet threads
- I-90-36V-B-43 = 8 cm pop-up, full-circle, opposing nozzles, with BSP inlet threads, and #43 nozzle
- I-90-3RV-B-63 = 8 cm pop-up, full-circle, opposing nozzles, reclaimed water ID, with BSP inlet threads, and #63 nozzle

I-90-ADV NOZZLE PERFORMANCE DATA							
Nozzle	Pressure		Radius m	Flow		Precip mm/hr	
	bar	kPa		m ³ /hr	l/min	■	▲
25 ● Lt. Blue	5.5	550	20.1	6.70	111.7	33.1	38.2
	6.0	600	20.4	7.16	119.2	34.3	39.6
	7.0	700	20.7	7.54	125.7	35.1	40.5
	7.5	750	21.0	8.09	134.8	36.6	42.2
33 ● Grey	5.5	550	20.7	8.22	137.0	38.3	44.2
	6.0	600	21.0	8.68	144.6	39.2	45.3
	7.0	700	21.3	9.18	152.9	40.3	46.6
	7.5	750	21.6	9.68	161.3	41.3	47.7
38 ● Red	5.5	550	21.9	9.22	153.7	38.3	44.2
	6.0	600	22.3	9.77	162.8	39.5	45.6
	7.0	700	22.9	10.31	171.9	39.5	45.6
	7.5	750	23.2	10.81	180.2	40.3	46.5
43 ● Dk. Brown	5.5	550	22.6	10.47	174.5	41.2	47.5
	6.0	600	22.6	11.02	183.6	43.3	50.0
	7.0	700	22.9	11.52	191.9	44.1	50.9
	7.5	750	23.5	12.13	202.1	44.0	50.9
48 ● Dk. Green	5.5	550	23.5	11.40	190.0	41.4	47.8
	6.0	600	24.1	11.95	199.1	41.2	47.6
	7.0	700	24.7	12.52	208.6	41.1	47.4
	7.5	750	25.0	13.06	217.7	41.8	48.3
53 ● Dk. Blue*	5.5	550	24.7	12.47	207.8	40.9	47.2
	6.0	600	25.6	12.99	216.5	39.6	45.8
	7.0	700	26.2	13.52	225.2	39.3	45.4
	7.5	750	26.5	14.11	235.1	40.1	46.3
	8.0	800	26.8	14.63	243.8	40.7	47.0
63 ● Black	5.5	550	26.2	14.15	235.8	41.2	47.6
	6.0	600	26.8	14.88	247.9	41.4	47.8
	7.0	700	27.4	15.67	261.2	41.7	48.1
	7.5	750	27.7	16.33	272.2	42.5	49.0
	8.0	800	28.0	16.97	282.8	43.2	49.8
73 ● Orange	5.5	550	27.1	16.51	275.2	44.9	51.8
	6.0	600	27.7	17.13	285.4	44.5	51.4
	7.0	700	28.3	17.74	295.6	44.2	51.0
	7.5	750	29.0	18.38	306.2	43.8	50.6
	8.0	800	29.6	19.04	317.2	43.5	50.3

* Factory-installed nozzle

Notes:

Precipitation rates for ADV models are calculated for 180° operation. Precipitation rates for 36V models are calculated for 360° operation. All triangular rates are equilateral. Complies to ASAE standard.

I-90-36V NOZZLE PERFORMANCE DATA							
Nozzle	Pressure		Radius m	Flow		Precip mm/hr	
	bar	kPa		m ³ /hr	l/min	■	▲
25 ● Lt. Blue	5.5	550	22.3	6.93	115.5	14.0	16.2
	6.0	600	22.9	7.36	122.6	14.1	16.3
	7.0	700	23.2	7.79	129.8	14.5	16.8
	7.5	750	23.8	8.29	138.2	14.7	16.9
33 ● Grey	5.5	550	23.5	8.25	137.4	15.0	17.3
	6.0	600	23.8	8.72	145.4	15.4	17.8
	7.0	700	24.4	9.22	153.7	15.5	17.9
	7.5	750	24.7	9.70	161.6	15.9	18.4
38 ● Red	5.5	550	24.4	9.22	153.7	15.5	17.9
	6.0	600	25.0	9.75	162.4	15.6	18.0
	7.0	700	25.3	10.29	171.5	16.1	18.6
	7.5	750	25.9	10.84	180.6	16.1	18.6
43 ● Dk. Brown	5.5	550	25.3	10.49	174.9	16.4	18.9
	6.0	600	25.6	11.04	184.0	16.8	19.4
	7.0	700	25.9	11.56	192.7	17.2	19.9
	7.5	750	26.2	12.13	202.1	17.7	20.4
48 ● Dk. Green	5.5	550	26.2	11.27	187.8	16.4	18.9
	6.0	600	27.1	11.93	198.7	16.2	18.7
	7.0	700	27.4	12.45	207.4	16.5	19.1
	7.5	750	27.7	13.02	216.9	16.9	19.5
53 ● Dk. Blue*	5.5	550	27.1	12.31	205.2	16.7	19.3
	6.0	600	27.4	12.88	214.6	17.1	19.8
	7.0	700	28.0	13.45	224.1	17.1	19.7
	7.5	750	28.3	14.02	233.6	17.4	20.1
	8.0	800	28.7	14.58	243.0	17.8	20.5
63 ● Black	5.5	550	28.0	14.36	239.2	18.3	21.1
	6.0	600	28.7	14.97	249.5	18.2	21.1
	7.0	700	29.3	15.76	262.7	18.4	21.3
	7.5	750	29.6	16.36	272.5	18.7	21.6
	8.0	800	29.9	17.01	283.5	19.1	22.0
73 ● Orange	5.5	550	29.3	16.38	272.9	19.1	22.1
	6.0	600	29.9	17.04	283.9	19.1	22.0
	7.0	700	30.2	17.67	294.5	19.4	22.4
	7.5	750	31.1	18.29	304.7	18.9	21.8
	8.0	800	31.4	18.92	315.3	19.2	22.2

I-90 NOZZLE



ADV & 36V

I-90



SWING JOINTS

With swivel ells on both ends, SJ Swing Joints easily adjust sprinklers to proper height and position in any configuration.

KEY BENEFITS













- Strength, longevity and contamination resistance
 - Prefabricated PVC design with O-ring seals
- Configurations to meet every installation requirement
 - Available in all popular inlet and outlet configurations
 - Choose from 20 cm, 30 cm, or 46 cm lay arm lengths
 - Single top-out or triple top-out designs

Swing Joints

- HSJ-0 = Model ¾"
- HSJ-1 = Model 1" (25 mm)
- HSJ-2 = Model 1¼" (30 mm)
- HSJ-3 = Model 1½" (40 mm)



SWING JOINT – SPECIFICATION BUILDER: ORDER 1 + 2 + 3 + 4 + 5

1 Model	2 Inlet Type (from pipe fitting)	3 Outlet Type (to sprinkler inlet)	4 Outlet Style	5 Lay Length
HSJ-0 = ¾" commercial Swing Joint HSJ-1 = 1" (25 mm) heavy-duty Swing Joint HSJ-2 = 1¼" (30 mm) heavy-duty Swing Joint HSJ-3 = 1½" (40 mm) heavy-duty Swing Joint	3 = Male NPT  4 = Male Acme*  6 = Male BSP**  7 = Spigot, 10 cm long**  M = Main Acme H-connection *** P = Main Acme V-connection <small>* Not available in HSJ-0 or HSJ-3. Use "M" inlet for HSJ-3. ** Not available in HSJ-0. *** Horizontal connection reduces from 40 mm Acme to Swing Joint size</small>	0 = Male Acme  2 = Male NPT  5 = Male BSP (not available in HSJ-0)  6 = Enlarging to 1½" (40 mm) male BSP* 8 = Enlarging to 1½" (40 mm) male Acme* A = Enlarging/reducing to 30 mm male Acme**	2 = Single top-out  4 = Triple top-out 	8 = 20 cm lay arm*  12 = 30 cm lay arm  18 = 46 cm lay arm**  <small>* HSJ-0 only ** Not available in HSJ-0</small>

Example:

HSJ-1-3-2-2-12 = HSJ 1" (25 mm) heavy-duty Swing Joint, 1" (25 mm) NPT inlet, 1" (25 mm) male NPT single top-out outlet, 30 cm lay arm length

SnapLok is a trademark of LASCO Fittings Inc.

SNAPLOK COMBO KITS

These kits are designed for applications that demand sturdy installation due to frequent Quick Coupler use.

KEY BENEFITS







- Versatile and cross-compatible for heavy-duty Quick Couplers
- Highly effective solution for Quick Coupler stabilisation
- SnapLok™ design includes:
 - Heavy-duty PVC and brass outlet construction
 - Anti-rotation coupler locking feature
 - Accommodates both rebar and pipe stabilisation
- Solves common quick-coupler stabilisation and unthreading concerns
 - Unique SnapLok outlet with integrated brass thread outlet
- See the HSJ Swing Joints on **page 42**



Quick Coupler with SnapLok
Equipped HSJ-1 Swing Joint

ROTORS

SNAPLOK COMBO KITS - SPECIFICATION BUILDER: ORDER 1 + 2 + 3 + 4 + 5

1 Model	2 Inlet Type (from pipe fitting)	3 Outlet Type (to sprinkler inlet)	4 Outlet Style	5 Lay Length
HSJ-1 = 1" (25 mm) heavy-duty Swing Joint	6 = Male BSP  2 = Short spigot 	S = 1" Male brass NPT SnapLok  T = ¾" Male brass NPT/BSP SnapLok U = 1" (25 mm) Male brass BSP SnapLok 	2 = Single top-out 	12 = 30 cm lay arm  18 = 46 cm lay arm 

Example:

HSJ-1-6-S-2-12 = HSJ 1" (25 mm) heavy-duty Swing Joint, 1" (25 mm) BSP inlet, 1" (25 mm) male brass outlet, single top-out, 30 cm lay arm length

HUNTER CHECK VALVES

Eliminate low-head drainage for both rotor and spray shrub systems with the adjustable Hunter Check Valve.

KEY BENEFITS

- Adjustment access from top of valve
- Adjusts to compensate for elevational changes up to 11 m
- Variety of inlet and outlet options reduces need for additional fittings
- Meets Schedule 80 specifications for durability under high pressure
- Pressure loss charts for HCV products on **page 257**

HUNTER CHECK VALVES	
Model	Description
HC-50F-50F	½" female inlet x ½" female outlet
HC-50F-50M	½" female inlet x ½" male outlet
HC-75F-75M	¾" female inlet x ¾" male outlet



HCV
Overall height: 7.5 cm

ST SYSTEM





ST-90-B

The ST-90-B Synthetic Turf Rotor is designed for installation in natural turf adjacent to the playing surface — the perfect solution for small and midsize fields.

KEY BENEFITS

- Arc setting: 40° to 360°
- QuickCheck™ Arc Mechanism
- Through-the-top arc adjustment
- Water-lubricated gear drive
- Factory-installed rubber logo cap
- Nozzle trajectory: 22.5°

OPERATING SPECIFICATIONS

- Radius: 31.4 m to 36.6 m
- Flow: 16.9 to 20.9 m³/hr; 282 to 348 l/min
- Operating pressure range: 6.9 to 8.3 bar; 690 to 830 kPa
- Precipitation rate: 35 mm/hr approximately
- Warranty period: 5 years for component parts

USER-INSTALLED OPTIONS

- Rubber Cover Kit ST-90: P/N 234200SP

ST ROTOR	
Model	Description
ST-90-B-XX	8 cm pop-up, jar-top cap, adjustable arc, plastic riser, and BSP inlet threads, #73 or #83 preinstalled nozzle



ST-90-B*

Overall height: 29 cm
Pop-up height: 8 cm
Diameter: 14 cm
Inlet size: 1½" (40 mm) BSP

* Not for use with the ST Vault

ST-90-B NOZZLE PERFORMANCE DATA

Nozzle	Pressure		Radius m	Flow		Precip mm/hr	
	bar	kPa		m ³ /hr	l/min	■	▲
73 ●	7.0	700	31.4	16.9	282	34.3	39.6
	7.5	750	33.2	17.5	291	31.7	36.6
Orange	8.0	800	35.1	18.1	301	29.4	34.0
	7.0	700	34.1	19.1	319	32.8	37.9
83 ●	7.5	750	35.4	20.0	333	32.0	37.0
	8.0	800	36.6	20.9	348	31.2	36.1

Notes:

All precipitation rates calculated for 180° operation.
For precipitation rate of a 360° sprinkler, divide by 2.

Requires minimum 7.0 bar; 700 kPa dynamic pressure supplied to Swing Joint inlet.

HIGH-FLOW SWING JOINTS

These durable Swing Joints are easy to position and ensure correct rotor installation height.

KEY BENEFITS

- Heavy-duty, high-flow Swing Joints with O-ring seals
- HSJ-4 for high-flow I-90 and ST-90 Rotors with 2" (50 mm) inlets

High-Flow Swing Joints
HSJ-4 = 50 mm model



HSJ HIGH-FLOW SWING JOINT - SPECIFICATION BUILDER: ORDER 1 + 2 + 3 + 4

1 Model	2 Inlet Type (from pipe fitting)	3 Outlet Type (to sprinkler inlet)	4 Outlet Style	5 Lay Length
HSJ-4 = 50 mm heavy-duty Swing Joint	6 = 2" (50 mm) male BSP, horizontal side connection	D = 1½" (40 mm) male BSP	2 = Single top-out	12 = 12" (30 cm) lay arm

Example:

HSJ-4-6-D-2-12 = HSJ 50 mm heavy-duty Swing Joint, 50 mm male BSP horizontal side connection to piping, 40 mm male BSP outlet to sprinkler, single top-out, and 30 cm lay arm

ST-1200-BR

The cost-effective ST-1200-BR Synthetic Turf Rotor is the ideal riser-mounted solution for pastures, corrals, arenas, dust control, and wash-down watering.

KEY BENEFITS

- Nozzle choices: 5 (included)
- Standard nozzle: #12
- Nozzle range: #10 to #18
- Nozzle trajectory: 22.5°
- Isolated, grease-lubricated gear drive
- Nozzle barrels: short and long (included)
- Movable stops (left and right) arc adjustment
- Arc setting: 40° to non-reversing 360°
- Ratcheting nozzle turret

OPERATING SPECIFICATIONS

- Radius: 20.4 m to 35.1 m
- Flow: 6.13 to 29.76 m³/hr; 102.1 to 495.9 l/min
- Recommended pressure range: 2.0 to 6.0 bar; 200 to 600 kPa



ST-1200-BR

Overall height: 30 cm
Overall length: 30 cm
Overall width: 10 cm
Inlet size: 1½" (40 mm) BSP

*Use P/N 241401SP adapter to connect to 1½" (40 mm) PVC pipe if needed

Included

Short and long barrels

ST-1200-BR NOZZLE PERFORMANCE DATA

Nozzle	Pressure		Radius m	Flow		Precip in/hr	
	Bar	kPa		m ³ /hr	l/min	■	▲
10 ●	2.0	200	20.4	6.13	102.2	29.4	34.0
	3.0	300	22.9	7.45	124.2	28.5	32.9
	4.0	400	25.9	8.65	144.2	25.8	29.8
	5.0	500	27.4	9.88	164.7	26.3	30.3
12 ●	2.0	200	20.7	7.63	127.2	35.5	41.0
	3.0	300	23.8	9.36	156.0	33.1	38.2
	4.0	400	26.8	10.81	180.2	30.1	34.7
	5.0	500	29.9	12.06	201.0	27.0	31.2
14 ●	2.0	200	21.3	10.38	173.0	45.6	52.7
	3.0	300	26.2	12.72	212.0	37.0	42.8
	4.0	400	30.5	14.70	244.9	31.6	36.5
	5.0	500	33.5	16.47	274.4	29.3	33.8
16 ●	2.0	200	21.9	13.52	225.2	56.1	64.8
	3.0	300	28.3	16.58	276.3	41.3	47.7
	4.0	400	31.4	19.15	319.1	38.9	44.9
	5.0	500	35.4	18.38	306.2	29.4	33.9
18 ●	3.0	300	29.0	21.01	350.1	50.1	57.9
	4.0	400	31.7	24.31	405.0	48.4	55.9
	5.0	500	33.8	27.15	452.4	47.4	54.8
	6.0	600	35.1	29.76	495.9	48.4	55.9

ST-1200-BR Installed



ST-1600-HS-BR

In addition to synthetic turf, this heavy-duty rotor is designed for irrigating pastures, horse arenas, dust control, and natural turf areas.

KEY BENEFITS

- Nozzle choices: 6
- Standard nozzle: #20
- Nozzle range: #16 to #26
- Nozzle trajectory: 25°
- Movable stops with left and right arc adjustment
- Arc setting: 40° to non-reversing 360°
- Ratcheting nozzle turret

OPERATING SPECIFICATIONS

- Radius: 32.5 to 50.3 m
- Flow: 21.8 to 74.2 m³/hr; 364 to 1,237 l/min
- Operating pressure range: 4.0 to 8.0 bar; 400 to 800 kPa
- Precipitation rate: 60 mm/hr approximately
- Warranty period: 5 years for component parts



ST-1600-HS-BR (High-Speed)
(Riser-Mounted Model)
Overall height: 22 cm
Diameter: 21 cm
Inlet size: 2" (50 mm) BSP*

*Use P/N 241400SP adapter to connect to 2" (50 mm) PVC pipe if needed

ST-1600-HS-BR NOZZLE PERFORMANCE DATA*

Nozzle	Pressure		Radius m	Flow		Precip mm/hr	
	bar	kPa		m ³ /hr	l/min	■	▲
16 ●	4.0	400	32.5	21.8	364	41.4	47.8
	5.0	500	35.0	24.4	406	39.8	45.9
	6.0	600	37.0	26.8	446	39.1	45.1
	7.0	700	39.0	28.9	482	38.0	43.9
	8.0	800	41.0	31.2	520	37.1	42.9
18 ●	4.0	400	34.0	24.3	405	42.0	48.6
	5.0	500	37.0	27.1	452	39.6	45.8
	6.0	600	39.0	29.8	496	39.1	45.2
	7.0	700	40.5	32.1	535	39.1	45.2
	8.0	800	43.0	34.8	580	37.6	43.5
20 ●	4.0	400	35.0	32.7	545	53.4	61.7
	5.0	500	39.0	36.5	609	48.1	55.5
	6.0	600	43.0	40.1	668	43.4	50.1
	7.0	700	44.0	43.3	721	44.7	51.6
	8.0	800	45.0	46.4	773	45.8	52.9
22 ●	4.0	400	36.0	38.9	649	60.1	69.4
	5.0	500	39.5	43.6	726	55.8	64.5
	6.0	600	44.0	47.7	795	49.3	56.9
	7.0	700	47.0	51.5	859	46.7	53.9
	8.0	800	48.0	55.2	920	47.9	55.3
24 ●	4.0	400	37.0	45.9	765	67.1	77.4
	5.0	500	40.5	51.3	855	62.6	72.2
	6.0	600	45.0	56.2	937	55.5	64.1
	7.0	700	47.5	60.7	1012	53.8	62.2
	8.0	800	48.7	65.0	1084	54.9	63.3
26 ●	4.0	400	38.4	53.0	883	71.8	82.9
	5.0	500	41.4	59.2	986	68.8	79.5
	6.0	600	46.0	64.6	1077	61.0	70.4
	7.0	700	48.7	69.7	1162	58.6	67.7
	8.0	800	50.3	74.2	1237	58.7	67.8

*All radius measurements are taken at standard rotation speeds. Slowing rotation to the minimum rotation speed will add 3+ meters to the radius.

ST-1600-HS-BR Installed



ST-1700-V

This ST System includes a valve-in-head design for faster installation and maintenance.

KEY BENEFITS

- Nozzle choices: 5
- Standard nozzle: #20
- Nozzle range: #16 to #24
- Nozzle trajectory: 25°
- Total-Top-Service (TTS) design provides convenient no-dig servicing
- Valve-in-head configuration simplifies installation
- Isolated, grease-lubricated gear drive
- Factory-installed rubber logo cap
- Arc adjustment: movable stops for left/right arc adjustment
- Ratcheting nozzle turret

OPERATING SPECIFICATIONS

- Radius: 32 to 48 m
- Flow: 21.0 to 58.8 m³/hr; 350 to 980 l/min
- Operating pressure range: 4.0 to 8.0 bar; 400 to 800 kPa
- Arc setting: 40° to non-reversing 360°
- Speed of rotation: 80 seconds at 6.0 bar; 600 kPa (single 180° sweep)
- Precipitation rate: 45 mm/hr approximately
- Warranty period: 5 years for component parts



ST-1700-V

Overall height: 68 cm
Pop-up height: 13 cm
Top: 33 cm x 39 cm
Inlet size: 2" (50 mm) BSP*

*Use P/N 241400SP adapter to connect to 2" (50 mm) PVC pipe if needed



ST-1700-V Valve Tool

P/N 100001005P
For installation and removal of inlet valve



Snap-Ring Tool

P/N 251000SP



ST1600/ST1700 Tool

P/N 517600SP
For gear-drive installation and removal

ST-1700-V NOZZLE PERFORMANCE DATA							
Nozzle	Pressure		Radius	Flow		Precip mm/hr	
	bar	kPa		m	m ³ /hr	l/min	■
16 ●	4.0	400	32.0	21.0	350	41.0	47.3
	5.0	500	35.0	22.7	379	37.1	42.8
	6.0	600	37.0	25.9	432	37.8	43.7
	7.0	700	38.5	28.1	469	38.0	43.9
	8.0	800	40.0	30.4	508	38.1	43.9
18 ●	4.0	400	34.0	24.3	405	42.0	48.5
	5.0	500	36.5	26.1	435	39.2	45.3
	6.0	600	38.5	28.8	481	38.9	44.9
	7.0	700	40.0	31.1	519	38.9	44.9
	8.0	800	42.0	33.8	564	38.3	44.3
20 ●	4.0	400	35.0	30.4	508	49.7	57.4
	5.0	500	39.0	34.3	572	45.1	52.0
	6.0	600	41.0	37.2	621	44.3	51.1
	7.0	700	43.0	40.9	681	44.2	51.0
	8.0	800	45.0	44.0	733	43.4	50.1
22 ●	4.0	400	35.5	34.9	582	55.4	63.9
	5.0	500	39.0	39.5	659	51.9	60.0
	6.0	600	43.0	42.9	715	46.4	53.6
	7.0	700	45.5	46.8	780	45.2	52.2
	8.0	800	47.0	50.4	841	45.7	52.7
24 ●	4.0	400	37.0	40.2	671	58.8	67.9
	5.0	500	40.5	45.6	761	55.6	64.2
	6.0	600	44.0	50.4	840	52.1	60.1
	7.0	700	47.0	54.5	908	49.3	57.0
	8.0	800	48.0	58.8	980	51.0	58.9

STG-900-KIT-B / STG-900

This top-quality, long-range system is specially designed for synthetic turf sports field irrigation.

KEY BENEFITS

- Arc setting: 40° to 360°
- QuickCheck™ Arc Mechanism
- Through-the-top arc adjustment
- Water-lubricated gear drive
- Factory-installed rubber logo cap
- Nozzle trajectory: 22.5°

OPERATING SPECIFICATIONS

- Radius: 31.4 m to 36.6 m
- Flow: 16.9 to 20.9 m³/hr; 282 to 348 l/min
- Operating pressure range: 6.9 to 8.3 bar; 690 to 830 kPa
- Precipitation rate: 35 mm/hr approximately
- Warranty period: 5 years for component parts

USER-INSTALLED OPTIONS

- Rubber cover kit STG-900: P/N 473900SP



STG-900*

Overall height: 36 cm
Pop-up height: 8 cm
Diameter: 20 cm
Inlet size: 1½" (40 mm) Acme

*For use with the ST-173026-B Vault

STG-900-KIT-B

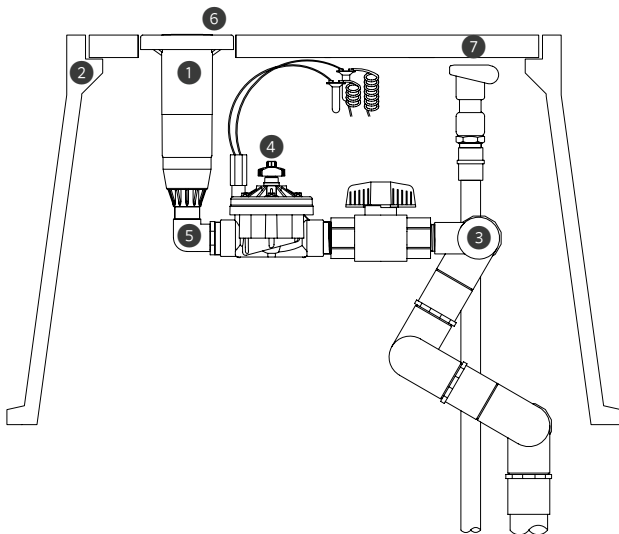

STG-900-KIT-B COMPONENTS

FIGURE	COMPONENTS	QTY	DESCRIPTION
1	STG-900-83	1	Pop-up, top serviceable, adjustable arc (40°–360°), 1½" (40 mm) Acme inlet
2	ST-173026-B	1	Composite vault, pre-cast hole for rotor and quick coupler
3	ST-2008-VA	1	Vertical alignment PVC Swing Joint, seven pivot points, 2" (50 mm) female slip inlet, 1½" (40 mm) female Acme outlet
4	ST-VBVF-K	1	ICV-151G valve, manifold ball valve, 1½" (40 mm) Acme inlet, 1½" (40 mm) Acme outlet
5	239800	1	1½" (40 mm) elbow, female Acme to male Acme, connects STG-900 rotor to ST-VBVF-K
6	473900SP	1	STG-900 rubber cover kit
7	HQ-5-RC-BSP	1	Quick coupler, 1" BSP inlet, 1¼" outlet for key

STG-900 Rotor



STG-900 NOZZLE PERFORMANCE DATA

Nozzle	Pressure		Radius m	Flow		Precip mm/hr	
	bar	kPa		m ³ /hr	l/min	■	▲
73 ●	7.0	700	31.4	16.9	282	34.3	39.6
	7.5	750	33.2	17.5	291	31.7	36.6
Orange	8.0	800	35.1	18.1	301	29.4	34.0
83 ●	7.0	700	34.1	19.1	319	32.8	37.9
	7.5	750	35.4	20.0	333	32.0	37.0
Tan	8.0	800	36.6	20.9	348	31.2	36.1

Notes:

All precipitation rates are calculated for 180° operation. For the precipitation rate of a 360° sprinkler, divide by 2.

Requires minimum 7.0 bar; 700 kPa dynamic pressure supplied to the Swing Joint inlet.

ST SWING JOINTS

Multiaxis 22 bar; 2,200 kPa rated vertical alignment PVC Swing Joints with seven O-ring sealed pivot points allow the rotor to be perfectly placed within the ST Vault's cover set opening.

ST-2008-VA: 2" (50 mm) for STG-900

Inlet: 2" (50 mm) slip*
Outlet: 1½" (40 mm) Acme

*Use P/N 241400 adapter to connect to male BSP threads

Adapter fitting 239300
Connects 239800 elbow fitting to STG-900 Acme inlet rotor



ST VALVE SETS

Heavy-duty control valves are configured to complement the ST Rotors and ST Vaults.

ST-VBVF-K: for STG-900-KIT-B

Valve: 1½" (40 mm) NPT ICV
Ball valve: 22 bar (2,200 kPa) rating
Inlet: 1½" (40 mm) Acme
Outlet: 1½" (40 mm) Acme

Low-pressure-loss design: 0.7 bar; 70 kPa at 22.7 m³/hr; 378 l/min from Swing Joint inlet through to rotor
Includes: 1½" (40 mm) connection fittings



ST VAULTS

Heavy-duty tapered fibreglass and polymer-concrete construction with pre-cast holes for rotor and quick-coupler valve.

ST-173026-B for STG-900-KIT-B includes 50 mm thick, 3-piece cover set

Main cover: 43 cm x 76 cm
Overall height: 66 cm
Body weight: 47 kg
Total weight: 73 kg
Base pad: 68 cm x 104 cm
Quick-access ports: 1



① Quick Coupler

All ST Vaults include convenient quick-access ports. Quick couplers provide a convenient source of water for washing down spills and water-soluble paint. The integrated in-vault design eliminates the need for additional quick-coupler enclosures.

ST-1600-KIT-B / ST-1600-HS-B

This all-in-one solution offers unmatched cleaning, cooling, and flushing capabilities to prepare synthetic sports fields for play.

KEY BENEFITS

- Nozzle choices: 6
- Standard nozzle: #20
- Nozzle range: #16 to #26
- Nozzle trajectory: 25°
- Isolated, grease-lubricated gear drive
- Movable stops (left and right) arc adjustment
- Arc setting: 40° to non-reversing 360°
- Ratcheting nozzle turret
- Adjustable speed of rotation: 0 to 65 seconds (high-speed models, 180° at 8 bar; 800 kPa)

OPERATING SPECIFICATIONS

- Radius: 32.5 to 50.3 m
- Flow: 21.8 to 74.2 m³/hr; 364 to 1,237 l/min
- Operating pressure range: 4.0 to 8.0 bar; 400 to 800 kPa
- Precipitation rate: 60 mm/hr approximately
- Warranty period: 5 years for component parts

USER-INSTALLED OPTIONS

- Simulated concrete cover for attachment for flattened ISB (used with vault): P/N ST-FRP-1600
- ST approved adhesive for attaching artificial turf, track, or ST-FRP-1600 to infill barrier system: P/N ST-ADH-K
- ST-1600 short-radius nozzle kit: P/N 959900
- Adapter, 2" (50 mm) slip x 2" (50 mm) male BSP: P/N 241400SP
- DC-latching solenoid kit: P/N ST-LSA



ST-1600-HS-B (High-Speed)

Overall height: 57 cm
Pop-up height: 13 cm
Diameter: 36 cm
Inlet size: 2" (50 mm) BSP*

* Use P/N 241400SP adapter to 2" (50 mm) PVC pipe if needed



ST1600/ST1700 Tool

P/N 517600SP
For gear-drive installation and removal

ST-1600-KIT-B

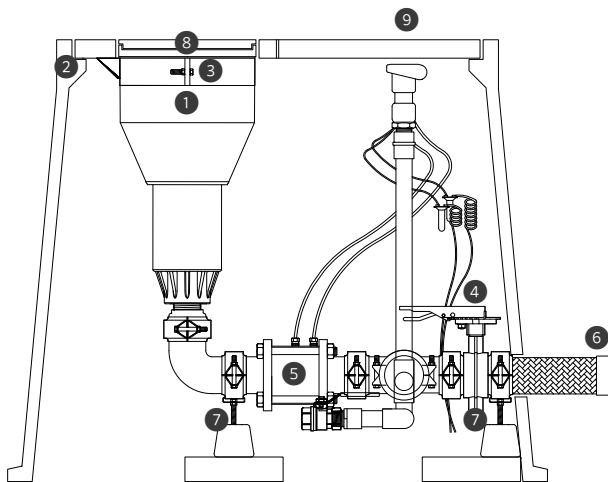

ST-1600-KIT-B COMPONENTS

FIGURE	COMPONENTS	QTY	DESCRIPTION
1	ST-1600-HS-B	1	High-speed pop-up, adjustable arc (40°-360°), 2" (50 mm) BSP inlet
2	ST-243636-B	1	Composite vault
3	ST-BKT-1600	1	Rotor vault hanger and grade adjustment bracket for ST-1600-HS-B rotor
4	ST-BVF30-K	1	Manifold butterfly valve and Victaulic® coupling fitting kit
5	ST-V30-KV	1	3" (80 mm) metal control valve, 80 mm grooved Victaulic inlet/outlet fitting, 91 cm remotely located solenoid and on-off-auto selector manifold
6	ST-H30-K	1	Stainless steel inlet hose 3" (80 mm) female NPT inlet
7	ST-SPT-K	2	Adjustable manifold support stand; two required per vault
8	ST-IBS-1600	1	Infill barrier system rubber cover kit for ST-1600-HS-B rotor
9	HQ-5-RC-BSP	1	Quick coupler, 1" (25 mm) BSP inlet, 1/4" (32 mm) outlet for key

Victaulic is a trademark of Victaulic Company.

ST Infill Barrier System

ST-IBS-1600
Rubber cover kit with infill barrier system surface area.

ST Adjustable Hanger Bracket

ST-BKT-1600
This bracket supports the rotor within the vault and provides vertical elevation adjustments allowing for a perfect surface transition.

ST Manifold and Isolation Valve

ST-BVF30-K
Galvanized iron manifold, including 3" (80 mm) fitting, isolation valve, and drain valve.



ST H-Block Manifold Supports

ST-SPT-K
Adjustable support stands include a large footprint base made from recycled tire rubber and a 50 mm vertically adjustable support rail (two required under manifold).



ST Flexible Stainless Inlet Hose

ST-H30-K
3" (80 mm) ultra-flexible stainless steel corrugated hose with stainless steel support braiding.

ST Heavy-Duty, Slow-Opening Valve

ST-V30-KV
3" (80mm) Ultra-low-pressure-loss valve (0.15 bar; 15kPa at 65.0 m³/hr; 1082 l/min). Includes on-off-auto selector and solenoid (not shown).



ST-1600 NOZZLE PERFORMANCE DATA*

Nozzle	Pressure		Radius m	Flow		Precip mm/hr	
	bar	kPa		m³/hr	l/min	■	▲
16 ● Black	4.0	400	32.5	21.8	364	41.4	47.8
	5.0	500	35.0	24.4	406	39.8	45.9
	6.0	600	37.0	26.8	446	39.1	45.1
	7.0	700	39.0	28.9	482	38.0	43.9
18 ● Black	4.0	400	34.0	24.3	405	42.0	48.6
	5.0	500	37.0	27.1	452	39.6	45.8
	6.0	600	39.0	29.8	496	39.1	45.2
	7.0	700	40.5	32.1	535	39.1	45.2
20 ● Black	4.0	400	35.0	32.7	545	53.4	61.7
	5.0	500	39.0	36.5	609	48.1	55.5
	6.0	600	43.0	40.1	668	43.4	50.1
	7.0	700	44.0	43.3	721	44.7	51.6
22 ● Black	4.0	400	36.0	38.9	649	60.1	69.4
	5.0	500	39.5	43.6	726	55.8	64.5
	6.0	600	44.0	47.7	795	49.3	56.9
	7.0	700	47.0	51.5	859	46.7	53.9
24 ● Black	4.0	400	37.0	45.9	765	67.1	77.4
	5.0	500	40.5	51.3	855	62.6	72.2
	6.0	600	45.0	56.2	937	55.5	64.1
	7.0	700	47.5	60.7	1012	53.8	62.2
26 ● Black	4.0	400	38.4	53.0	883	71.8	82.9
	5.0	500	41.4	59.2	986	68.8	79.5
	6.0	600	46.0	64.6	1077	61.0	70.4
	7.0	700	48.7	69.7	1162	58.6	67.7
	8.0	800	50.3	74.2	1237	58.7	67.8

*All radius measurements are taken at standard rotation speeds. Slowing rotation to the minimum rotation speed will add 3+ metres to the radius.

SEAMLESS INTEGRATION

Blends in perfectly with the surrounding synthetic surface



ST VAULTS

The heavy-duty tapered fibreglass and polymer-concrete construction includes pre-cast holes for the rotor, quick-coupler valve, and remote manifold assembly.

Quick couplers provide a convenient source of water for washing down spills and water-soluble paint. The integrated in-vault design eliminates the need for additional quick-coupler enclosures.

The ST-V30-KV valve kit includes a remotely located on-off-auto selector and solenoid manifold assembly. These convenient features bring valve manual control functions and solenoid splice connections closer to the surface for easy access.

ST-243636-B: includes 76 mm thick, 4-piece PC cover set

- Main cover: 61 cm x 91 cm
- Overall height: 91 cm
- Body weight: 70 kg
- Total weight: 138 kg
- Base pad: 106 cm x 122 cm
- Quick-access ports: 2



① Quick Coupler ② On-Off-Auto Selector

MP ROTATOR®

MP ROTATOR





ADVANCED FEATURES

AUTOMATIC MATCHED PRECIPITATION

MP Rotator Nozzles adjust the flow rate through the nozzle as the radius and arc are changed, resulting in the same matched precipitation rate regardless of the nozzle setting.

DOUBLE-POP FEATURE

MP Rotator Nozzles pop up from their protected position only after the riser is fully extended, providing superior defense against dirt and debris.



HIGH DISTRIBUTION UNIFORMITY

The multiple streams of the MP Rotator target all areas of the landscape evenly, resulting in superior uniformity over traditional spray nozzles and better wind resistance.

LOW PRECIPITATION RATE

Since the majority of soils have a water infiltration rate of less than 25 mm/hr, irrigating at a low precipitation rate is essential to reduce runoff and increase efficiency.

The Standard MP Rotator applies water at 10 mm/hr, while the MP800 has a precipitation rate of 20 mm/hr. Either choice will avoid runoff, save water, and prevent erosion.

STANDARD MP Rotator

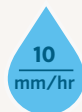

2.5-10.7 m

- Maximum water efficiency
- Slowest precipitation rate

MP800

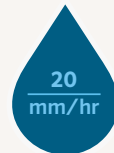

1.8-4.9 m

- Small spaces
- Tight water windows

MP STRIPS



1.5 m wide

- Rectangular spaces
- Pair with either option

ECO-ROTATOR

Radius: 2.5 to 9.1 m

This compact sprinkler comes with a pre-installed MP Rotator® Nozzle that provides up to 30% more water savings over traditional spray nozzles.

KEY BENEFITS

- Automatic matched precipitation for simplified irrigation design and flexibility
- High distribution uniformity for a healthy landscape and maximum water efficiency
- Double-pop feature protects the nozzle from external debris
- Large inlet filter screen protects the nozzle from internal debris in the system
- Heavy-duty spring for consistent riser retraction

ADDITIONAL FEATURES

- Wind-resistant, multi-stream technology prevents misting
- For vandal resistance, the arc is adjustable only when the MP Rotator is running
- Colour-coded for easy field identification
- Two-piece ratcheting riser

OPERATING SPECIFICATIONS

- Low precipitation rate
- Radius range: 1.8 to 9.1 m
- Operational pressure range: 1.7 to 3.8 bar; 170 to 380 kPa
- Recommended operating pressure: 2.8 bar; 280 kPa
- Warranty period: 2 years

USER-INSTALLED OPTION

- Drain Check Valve (up to 2 m of elevation; P/N 462237SP)



Eco-Rotator
 Retracted height: 18 cm
 Pop-up height: 10 cm
 Exposed diameter: 3 cm
 Inlet size: ½"

ECO-ROTATOR PERFORMANCE DATA

ECO-04 MP800SR

Radius: 1.8 to 3.5 m

Adjustable Arc and Full-Circle

● Orange and Grey: 90° to 210°

● Lime Green and Grey: 360°

Arc	Pressure		Radius	Flow		Precip. mm/hr		MIN RADIUS		
	bar	kPa		m	m ³ /hr	l/min	■	▲	Radius	Flow
								m	m ³ /hr	l/min
90° ■	2.1	200	2.6	0.04	0.61	22	25	1.8	0.03	0.49
	2.5	250	2.9	0.04	0.72	21	24	2.1	0.03	0.55
	2.8	280	3.1	0.05	0.87	21	24	2.4	0.04	0.61
	3.0	300	3.4	0.06	0.95	20	23	2.4	0.04	0.68
	3.5	350	3.5	0.06	1.02	20	23	2.7	0.04	0.72
	3.8	380	3.5	0.06	1.06	20	23	3.0	0.05	0.76
180° ■	2.1	200	2.6	0.07	1.21	22	25	1.8	0.06	0.98
	2.5	250	2.8	0.08	1.40	21	24	2.1	0.07	1.10
	2.8	280	3.0	0.10	1.59	21	24	2.4	0.07	1.21
	3.0	300	3.3	0.10	1.74	19	22	2.4	0.08	1.36
	3.5	350	3.4	0.11	1.82	19	22	2.7	0.09	1.44
	3.8	380	3.5	0.11	1.89	18	21	3.0	0.09	1.51
210° ■	2.1	200	2.6	0.08	1.40	22	25	1.8	0.07	1.15
	2.5	250	2.8	0.10	1.67	22	25	2.1	0.08	1.28
	2.8	280	3.0	0.11	1.85	21	24	2.4	0.08	1.41
	3.0	300	3.2	0.12	2.01	20	23	2.4	0.10	1.59
	3.5	350	3.4	0.13	2.12	19	22	2.7	0.10	1.68
	3.8	380	3.5	0.13	2.20	18	21	3.0	0.11	1.77
360° ●	2.1	200	2.6	0.14	2.38	22	25	1.8	0.11	1.78
	2.5	250	2.8	0.16	2.65	20	23	2.1	0.12	1.97
	2.8	280	3.0	0.18	2.95	20	23	2.4	0.13	2.12
	3.0	300	3.1	0.19	3.22	20	23	2.4	0.13	2.23
	3.5	350	3.3	0.20	3.33	19	21	2.7	0.14	2.38
	3.8	380	3.5	0.22	3.71	18	21	3.0	0.16	2.65

Bold = Recommended pressure

ECO-ROTATOR

Model	Description
ECO-04-800SR-90	10 cm pop-up, MP800SR 1.8 to 3.5 m radius, adjustable from 90° to 210°
ECO-04-800SR-360	10 cm pop-up, MP800SR 1.8 to 3.5 m radius, 360°
ECO-04-1090	10 cm pop-up, MP1000 2.5 to 4.5 m radius, adjustable from 90° to 210°
ECO-04-10360	10 cm pop-up, MP1000 2.5 to 4.5 m radius, 360°
ECO-04-2090	10 cm pop-up, MP2000 4.0 to 6.4 m radius, adjustable from 90° to 210°
ECO-04-20360	10 cm pop-up, MP2000 4.0 to 6.4 m radius, 360°
ECO-04-3090	10 cm pop-up, MP3000 6.7 to 9.1 m radius, adjustable from 90° to 210°
ECO-04-30360	10 cm pop-up, MP3000 6.7 to 9.1 m radius, 360°

Eco-Rotator



ECO-ROTATOR PERFORMANCE DATA

Arc	Pressure		ECO-04 MP1000 Radius: 2.5 to 4.5 m Adjustable Arc and Full-Circle ● Maroon: 90° to 210° ● Olive: 360°					ECO-04 MP2000 Radius: 4.0 to 6.4 m Adjustable Arc and Full-Circle ● Black: 90° to 210° ● Red: 360°					ECO-04 MP3000 Radius: 6.7 to 9.1 m Adjustable Arc and Full-Circle ● Blue: 90° to 210° ● Grey: 360°				
	bar	kPa	Radius m	Flow m ³ /hr	Flow l/min	Precip mm/hr ■ ▲	Radius m	Flow m ³ /hr	Flow l/min	Precip mm/hr ■ ▲	Radius m	Flow m ³ /hr	Flow l/min	Precip mm/hr ■ ▲			
90° ■	1.7	170	-	-	-	-	5.2	0.08	1.29	12	13	7.6	0.16	2.69	11	13	
	2.0	200	3.7	0.04	0.64	11	13	5.5	0.09	1.44	12	13	8.2	0.17	2.88	10	12
	2.5	250	4.0	0.04	0.72	11	13	5.8	0.09	1.52	11	13	8.5	0.19	3.11	10	12
	2.8	280	4.1	0.05	0.80	11	13	6.1	0.10	1.63	11	12	9.1	0.20	3.26	10	11
	3.0	300	4.3	0.05	0.87	11	13	6.4	0.11	1.74	10	12	9.1	0.21	3.41	10	12
	3.5	350	4.5	0.06	0.95	11	13	6.4	0.11	1.78	11	12	9.1	0.22	3.60	11	12
3.8	380	4.5	0.06	1.02	12	14	6.4	0.11	1.82	11	12	9.1	0.23	3.83	11	13	
180° ■	1.7	170	-	-	-	-	4.9	0.14	2.27	11	13	7.6	0.33	5.46	11	13	
	2.0	200	3.7	0.08	1.29	11	13	5.2	0.15	2.43	11	13	8.2	0.36	5.99	11	12
	2.5	250	4.0	0.09	1.44	11	13	5.5	0.16	2.69	11	12	8.5	0.39	6.44	11	12
	2.8	280	4.1	0.10	1.59	11	13	5.8	0.18	2.92	11	12	9.1	0.42	6.90	10	12
	3.0	300	4.3	0.10	1.67	11	13	6.1	0.20	3.22	11	12	9.1	0.44	7.31	11	12
	3.5	350	4.5	0.12	1.90	11	13	6.4	0.21	3.45	10	12	9.1	0.47	7.73	11	13
3.8	380	4.5	0.12	1.93	12	13	6.4	0.22	3.60	11	12	9.1	0.49	8.07	12	14	
210° ■	1.7	170	-	-	-	-	4.9	0.17	2.73	12	14	7.6	0.39	6.37	11	13	
	2.0	200	3.7	0.09	1.52	12	13	5.2	0.17	2.84	11	13	8.2	0.42	6.97	11	12
	2.5	250	4.0	0.10	1.71	11	13	5.5	0.19	3.07	11	12	8.5	0.46	7.54	11	13
	2.8	280	4.1	0.11	1.86	11	13	5.8	0.20	3.26	10	12	9.1	0.49	8.03	10	12
	3.0	300	4.3	0.12	1.93	11	13	6.1	0.21	3.45	10	11	9.1	0.52	8.53	11	12
	3.5	350	4.5	0.13	2.16	11	13	6.4	0.23	3.71	9	11	9.1	0.55	8.98	11	13
3.8	380	4.5	0.14	2.24	11	13	6.4	0.23	3.83	10	11	9.1	0.57	9.44	12	14	
360° ●	1.7	170	-	-	-	-	4.9	0.28	4.55	11	13	7.6	0.66	10.92	11	13	
	2.0	200	3.7	0.16	2.62	12	13	5.2	0.29	4.85	11	13	8.2	0.72	11.94	11	12
	2.5	250	4.0	0.18	2.92	11	13	5.5	0.32	5.19	10	12	8.5	0.78	12.89	11	12
	2.8	280	4.1	0.19	3.18	11	13	5.8	0.34	5.61	10	12	9.1	0.84	13.80	10	12
	3.0	300	4.3	0.20	3.34	11	13	6.1	0.36	5.95	10	11	9.1	0.89	14.63	11	12
	3.5	350	4.5	0.23	3.71	11	13	6.4	0.39	6.37	9	11	9.1	0.94	15.43	11	13
3.8	380	4.5	0.23	3.83	11	13	6.4	0.40	6.59	10	11	9.1	0.98	16.18	12	14	

Bold = Recommended pressure

MP ROTATOR®

Radius: 2.5 to 10.7 m

10
mm/hr

The MP Rotator Nozzle is the most trusted high-efficiency solution on the market, offering up to 30% water savings over traditional spray nozzles.

KEY BENEFITS

- Lowest precipitation rate in the industry of approximately 10 mm/hr
- Matched precipitation for simplified irrigation design and flexibility
- Double-pop feature protects the nozzle from external debris
- High distribution uniformity for a healthy landscape with maximum water efficiency

ADDITIONAL FEATURES

- Wind-resistant, multi-stream technology prevents misting
- For vandal resistance, the arc is adjustable only when the MP Rotator is running
- Removable filter screen prevents nozzle from clogging
- Colour-coded for easy identification

OPERATING SPECIFICATIONS

- Radius reduction up to approximately 25% on all models
- Recommended operating pressure: 2.8 bar; 280 kPa
- Minimum radius setting achieved at 2.1 bar; 210 kPa
- Warranty period: 3 years

OPTIONS

- Pair with Pro-Spray™ PRS40 Sprinkler Body for pressure regulation to 2.8 bar; 280 kPa for nominal radius settings
- Pair with Pro-Spray PRS30 Sprinkler Body for pressure regulation to 2.1 bar; 210 kPa for minimum radius settings

MP ROTATOR - SPECIFICATION BUILDER: ORDER 1 + 2

1 Model	2 Options
MP1000-90 = 2.5 to 4.5 m radius, adjustable from 90° to 210°	(blank) = No option HT = Male threaded version <i>(Not available in 3500 and 1000-210)</i>
MP1000-210 = 2.5 to 4.5 m radius, adjustable from 210° to 270°	
MP1000-360 = 2.5 to 4.5 m radius, 360°	
MP2000-90 = 4.0 to 6.4 m radius, adjustable from 90° to 210°	
MP2000-210 = 4.0 to 6.4 m radius, adjustable from 210° to 270°	
MP2000-360 = 4.0 to 6.4 m radius, 360°	
MP3000-90 = 6.7 to 9.1 m radius, adjustable from 90° to 210°	
MP3000-210 = 6.7 to 9.1 m radius, adjustable from 210° to 270°	
MP3000-360 = 6.7 to 9.1 m radius, 360°	
MP3500-90 = 9.4 to 10.7 m radius, adjustable from 90° to 210°	
MPLCS-515 = Left corner strip, 1.5 m x 4.6 m	
MPRCS-515 = Right corner strip, 1.5 m x 4.6 m	
MPSS-530 = Side strip, 1.5 m x 9.1 m	
MP-CORNER = 2.5 to 4.5 m radius, adjustable from 45° to 105°	

MP1000: 2.5 to 4.5 m radius



MP1000-90
90° to 210°



MP1000-210
210° to 270°



MP1000-360
360°

MP2000: 4.0 to 6.4 m radius



MP2000-90
90° to 210°



MP2000-210
210° to 270°



MP2000-360
360°

MP3000: 6.7 to 9.1 m radius



MP3000-90
90° to 210°



MP3000-210
210° to 270°



MP3000-360
360°

MP3500: 9.4 to 10.7 m radius



MP3500-90
90° to 210°

MP ROTATOR PERFORMANCE DATA

MP1000

Radius: 2.5 to 4.5 m
Adjustable Arc and Full-Circle
● Maroon: 90° to 210°
● Lt. Blue: 210° to 270°
● Olive: 360°

MP2000

Radius: 4.0 to 6.4 m
Adjustable Arc and Full-Circle
● Black: 90° to 210°
● Green: 210° to 270°
● Red: 360°

MP3000

Radius: 6.7 to 9.1 m
Adjustable Arc and Full-Circle
● Blue: 90° to 210°
● Yellow: 210° to 270°
● Grey: 360°

Arc	Pressure		MP1000		MP2000		MP3000		Precip mm/hr		MP1000		MP2000		MP3000		Precip mm/hr	
	bar	kPa	Radius m	Flow m ³ /hr	Flow l/min	Radius m	Flow m ³ /hr	Flow l/min	Radius m	Flow m ³ /hr	Flow l/min	■ ▲	■ ▲	■ ▲	■ ▲	■ ▲	■ ▲	
90° 	1.7	170	-	-	-	-	-	-	5.2	0.08	1.29	12	13	7.6	0.16	2.69	11	13
	2.0	200	3.7	0.04	0.64	11	13	5.5	0.09	1.44	12	13	8.2	0.17	2.88	10	12	
	2.5	250	4.0	0.04	0.72	11	13	5.8	0.09	1.52	11	13	8.5	0.19	3.11	10	12	
	2.8	280	4.1	0.05	0.80	11	13	6.1	0.10	1.63	11	12	9.1	0.20	3.26	10	11	
	3.0	300	4.3	0.05	0.87	11	13	6.4	0.11	1.74	10	12	9.1	0.21	3.41	10	12	
	3.5	350	4.5	0.06	0.95	11	13	6.4	0.11	1.78	11	12	9.1	0.22	3.60	11	12	
	3.8	380	4.5	0.06	1.02	12	14	6.4	0.11	1.82	11	12	9.1	0.23	3.83	11	13	
180° 	1.7	170	-	-	-	-	-	-	4.9	0.14	2.27	11	13	7.6	0.33	5.46	11	13
	2.0	200	3.7	0.08	1.29	11	13	5.2	0.15	2.43	11	13	8.2	0.36	5.99	11	12	
	2.5	250	4.0	0.09	1.44	11	13	5.5	0.16	2.69	11	12	8.5	0.39	6.44	11	12	
	2.8	280	4.1	0.10	1.59	11	13	5.8	0.18	2.92	11	12	9.1	0.42	6.90	10	12	
	3.0	300	4.3	0.10	1.67	11	13	6.1	0.20	3.22	11	12	9.1	0.44	7.31	11	12	
	3.5	350	4.5	0.12	1.90	11	13	6.4	0.21	3.45	10	12	9.1	0.47	7.73	11	13	
	3.8	380	4.5	0.12	1.93	12	13	6.4	0.22	3.60	11	12	9.1	0.49	8.07	12	14	
210° 	1.7	170	-	-	-	-	-	-	4.9	0.17	2.73	12	14	7.6	0.39	6.37	11	13
	2.0	200	3.7	0.09	1.52	12	13	5.2	0.17	2.84	11	13	8.2	0.42	6.97	11	12	
	2.5	250	4.0	0.10	1.71	11	13	5.5	0.19	3.07	11	12	8.5	0.46	7.54	11	13	
	2.8	280	4.1	0.11	1.86	11	13	5.8	0.20	3.26	10	12	9.1	0.49	8.03	10	12	
	3.0	300	4.3	0.12	1.93	11	13	6.1	0.21	3.45	10	11	9.1	0.52	8.53	11	12	
	3.5	350	4.5	0.13	2.16	11	13	6.4	0.23	3.71	9	11	9.1	0.55	8.98	11	13	
	3.8	380	4.5	0.14	2.24	11	13	6.4	0.23	3.83	10	11	9.1	0.57	9.44	12	14	
270° 	1.7	170	-	-	-	-	-	-	4.9	0.20	3.30	11	13	7.6	0.50	8.30	12	13
	2.0	200	3.7	0.11	1.82	11	12	5.2	0.22	3.60	11	12	8.2	0.55	8.98	11	12	
	2.5	250	4.0	0.12	2.01	10	12	5.5	0.24	3.90	10	12	8.5	0.59	9.66	11	12	
	2.8	280	4.1	0.14	2.39	11	13	5.8	0.25	4.17	10	12	9.1	0.63	10.35	10	12	
	3.0	300	4.3	0.15	2.54	11	13	6.1	0.27	4.43	10	11	9.1	0.66	10.95	11	12	
	3.5	350	4.5	0.17	2.73	11	13	6.4	0.28	4.66	9	11	9.1	0.70	11.60	11	13	
	3.8	380	4.5	0.17	2.84	11	13	6.4	0.30	4.93	10	11	9.1	0.74	12.20	12	14	
360° 	1.7	170	-	-	-	-	-	-	4.9	0.28	4.55	11	13	7.6	0.66	10.92	11	13
	2.0	200	3.7	0.16	2.62	12	13	5.2	0.29	4.85	11	13	8.2	0.72	11.94	11	12	
	2.5	250	4.0	0.18	2.92	11	13	5.5	0.32	5.19	10	12	8.5	0.78	12.89	11	12	
	2.8	280	4.1	0.19	3.18	11	13	5.8	0.34	5.61	10	12	9.1	0.84	13.80	10	12	
	3.0	300	4.3	0.20	3.34	11	13	6.1	0.36	5.95	10	11	9.1	0.89	14.63	11	12	
	3.5	350	4.5	0.23	3.71	11	13	6.4	0.39	6.37	9	11	9.1	0.94	15.43	11	13	
	3.8	380	4.5	0.23	3.83	11	13	6.4	0.40	6.59	10	11	9.1	0.98	16.18	12	14	

Bold = Optimal pressure for the MP Rotator is 2.8 bar; 280 kPa. This can easily be achieved by using the MP Rotator with the Pro-Spray PRS40, pressure-regulated spray body at 2.8 bar; 280 kPa.

Works best with Pro-Spray PRS40



For Pro-Spray PRS40 information, see page 71



Smart WaterMark
Recognised as a responsible water-saving tool

Compatible with:



Pro-Spray PRS40
Page 71

MP ROTATOR PERFORMANCE DATA

MP3500
 Radius: 9.4 to 10.7 m
 Adjustable Arc
 ● Light Brown: 90° to 210°

Arc	Pressure		Radius m	Flow m ³ /hr	Flow l/min	Precip. mm/hr	
	bar	kPa				■	▲
90° ■	1.7	170	10.1	0.24	3.94	9	11
	2.0	200	10.4	0.26	4.28	10	11
	2.5	250	10.4	0.28	4.58	10	12
	2.8	280	10.7	0.29	4.84	10	12
	3.0	300	10.7	0.31	5.22	11	13
	3.5	350	10.7	0.33	5.41	11	13
	3.8	380	10.7	0.34	5.68	12	14
180° ●	1.7	170	10.1	0.50	8.36	10	11
	2.0	200	10.4	0.51	8.48	9	11
	2.5	250	10.4	0.60	10.03	11	13
	2.8	280	10.7	0.65	10.83	11	13
	3.0	300	10.7	0.70	11.73	12	14
	3.5	350	10.7	0.73	12.15	13	15
	3.8	380	10.7	0.75	12.41	13	15
210° ◐	1.7	170	10.1	0.59	9.80	10	12
	2.0	200	10.4	0.65	10.75	10	12
	2.5	250	10.4	0.70	11.66	11	13
	2.8	280	10.7	0.75	12.45	11	13
	3.0	300	10.7	0.80	13.40	12	14
	3.5	350	10.7	0.85	14.23	13	15
	3.8	380	10.7	0.90	14.91	13	16

MP3500



Bold = Optimal pressure for the MP Rotator is 2.8 bar; 280 kPa. This can easily be achieved by using the MP Rotator with the Pro-Spray PRS40, pressure-regulated spray body at 2.8 bar; 280 kPa.

MP ROTATOR PERFORMANCE DATA

● **MPLCS-515**: Ivory, MP Left Corner Strip
 ● **MPRCS-515**: Copper, MP Right Corner Strip
 ● **MPSS-530**: Brown, MP Side Strip

	Pressure		Radius m	Flow m ³ /hr	Flow l/min
	bar	kPa			
MP Left Corner Strip ■	1.7	170	1.1 x 4.2	0.04	0.67
	2.0	200	1.2 x 4.3	0.04	0.72
	2.5	250	1.4 x 4.5	0.05	0.79
	2.8	280	1.5 x 4.6	0.05	0.84
	3.0	300	1.6 x 4.7	0.06	0.87
	3.5	350	1.7 x 4.8	0.06	0.94
	3.8	380	1.8 x 4.9	0.06	0.99
MP Right Corner Strip ■	1.7	170	1.1 x 4.2	0.04	0.67
	2.0	200	1.2 x 4.3	0.04	0.72
	2.5	250	1.4 x 4.5	0.05	0.79
	2.8	280	1.5 x 4.6	0.05	0.84
	3.0	300	1.6 x 4.7	0.05	0.87
	3.5	350	1.7 x 4.8	0.06	0.94
	3.8	380	1.8 x 4.9	0.06	0.99
MP Side Strip ■	1.7	170	1.1 x 8.3	0.08	1.34
	2.0	200	1.2 x 8.6	0.09	1.43
	2.5	250	1.4 x 8.9	0.09	1.57
	2.8	280	1.5 x 9.1	0.10	1.66
	3.0	300	1.6 x 9.3	0.10	1.72
	3.5	350	1.7 x 9.6	0.11	1.87
	3.8	380	1.8 x 9.9	0.12	1.96

MP Strips



MPLCS-515
Left Corner Strip
1.5 x 4.6 m

MPRCS-515
Right Corner Strip
1.5 x 4.6 m

MPSS-530
Side Strip
1.5 x 9.1 m



Notes:

To match the precipitation rate of Standard MP Rotator models, use single-row or triangular spacing. To match the MP800, use rectangular spacing.

See **page 242** for precipitation rate calculation.

MP ROTATOR PERFORMANCE DATA

MP Corner
 Radius: 2.5 to 4.5 m
 Adjustable Arc
 ● Turquoise: 45° to 105°

Arc	Pressure		Radius m	Flow m ³ /hr	Flow l/min
	bar	kPa			
45°	1.7	170	--	--	--
	2.0	200	3.5	0.04	0.61
	2.5	250	4.0	0.04	0.68
	2.8	280	4.1	0.04	0.70
	3.0	300	4.3	0.04	0.73
	3.5	350	4.4	0.05	0.78
	3.8	380	4.5	0.05	0.81
90°	1.7	170	3.2	0.07	1.15
	2.0	200	3.5	0.08	1.27
	2.5	250	4.0	0.08	1.40
	2.8	280	4.1	0.09	1.44
	3.0	300	4.3	0.09	1.57
	3.5	350	4.4	0.10	1.67
	3.8	380	4.5	0.10	1.73
105°	1.7	170	3.2	0.08	1.34
	2.0	200	3.5	0.09	1.48
	2.5	250	4.0	0.10	1.63
	2.8	280	4.1	0.10	1.70
	3.0	300	4.3	0.11	1.83
	3.5	350	4.4	0.12	1.94
	3.8	380	4.5	0.12	2.00

MP Corner



MP-CORNER
 Corner
 2.5 to 4.5 m

Male Threaded



MP-HT
 Male Threaded

MP Accessories



MPTOOL
 Adjusts all MP Rotator
 Nozzles



MPSTICK
 Snaps onto any length of
 1" (25 mm) PVC to allow
 standing adjustment.
 PVC pipe not included.

MP Corner



MP Tool for easy adjustments



MP ROTATOR® 800

Radius: 1.8 to 4.9 m

20
mm/hr

The MP800 offers a higher precipitation rate perfect for small spaces and spray retrofits.

KEY BENEFITS

- Precipitation rate of approximately 20 mm/hr for spray retrofit applications
- Automatic matched precipitation for simplified irrigation design and flexibility
- Double-pop feature protects the nozzle from external debris
- High distribution uniformity for a healthy landscape with maximum water efficiency

ADDITIONAL FEATURES

- Wind-resistant, multi-stream technology prevents misting
- For vandal resistance, the arc is adjustable only when the MP Rotator is running
- Removable filter screen prevents nozzle clogging
- Colour-coded for easy identification

OPERATING SPECIFICATIONS

- Radius reduction up to approximately 25% on all models
- Recommended operating pressure: 2.8 bar; 280 kPa
- Minimum radius setting achieved at 2.1 bar; 210 kPa
- Filtration recommended on dirty water applications
- Warranty period: 3 years

OPTIONS

- Pair with Pro-Spray™ PRS40 Sprinkler Body for pressure regulation to 2.8 bar; 280 kPa for nominal radius settings
- Pair with Pro-Spray PRS30 Sprinkler Body for pressure regulation to 2.1 bar; 210 kPa for minimum radius settings

MP800SR: 1.8 m to 3.5 m radius



MP800SR-90
90° to 210°

MP800SR-360
360°

MP815: 2.5 m to 4.9 m radius



MP815-90
90° to 210°

MP815-210
210° to 270°

MP815-360
360°

Compatible with:



HY Filter
Page 163



PRS30 and PRS40
Page 70 and
Page 71

MP800SR-90







MP815-90



MP ROTATOR PERFORMANCE DATA

MP800SR

Radius: 1.8 to 3.5 m
Adjustable Arc and Full-Circle
● Orange and Grey: 90° to 210°
● Lime Green and Grey: 360°





MAX RADIUS							MIN RADIUS			
Arc	Pressure		Radius	Flow		Precip. mm/hr		Flow		
	bar	kPa	m	m ³ /hr	l/min	■	▲	m	m ³ /hr	l/min
90° 	2.1	200	2.6	0.04	0.61	22	25	1.8	0.03	0.49
	2.5	250	2.9	0.04	0.72	21	24	2.1	0.03	0.55
	2.8	280	3.1	0.05	0.87	21	24	2.4	0.04	0.61
	3.0	300	3.4	0.06	0.95	20	23	2.4	0.04	0.68
	3.5	350	3.5	0.06	1.02	20	23	2.7	0.04	0.72
	3.8	380	3.5	0.06	1.06	20	23	3.0	0.05	0.76
180° 	2.1	200	2.6	0.07	1.21	22	25	1.8	0.06	0.98
	2.5	250	2.8	0.08	1.40	21	24	2.1	0.07	1.10
	2.8	280	3.0	0.10	1.59	21	24	2.4	0.07	1.21
	3.0	300	3.3	0.10	1.74	19	22	2.4	0.08	1.36
	3.5	350	3.4	0.11	1.82	19	22	2.7	0.09	1.44
	3.8	380	3.5	0.11	1.89	18	21	3.0	0.09	1.51
210° 	2.1	200	2.6	0.08	1.40	22	25	1.8	0.07	1.15
	2.5	250	2.8	0.10	1.67	22	25	2.1	0.08	1.28
	2.8	280	3.0	0.11	1.85	21	24	2.4	0.08	1.41
	3.0	300	3.2	0.12	2.01	20	23	2.4	0.10	1.59
	3.5	350	3.4	0.13	2.12	19	22	2.7	0.10	1.68
	3.8	380	3.5	0.13	2.20	18	21	3.0	0.11	1.77
360° 	2.1	200	2.6	0.14	2.38	22	25	1.8	0.11	1.78
	2.5	250	2.8	0.16	2.65	20	23	2.1	0.12	1.97
	2.8	280	3.0	0.18	2.95	20	23	2.4	0.13	2.12
	3.0	300	3.1	0.19	3.22	20	23	2.4	0.13	2.23
	3.5	350	3.3	0.20	3.33	19	21	2.7	0.14	2.38
	3.8	380	3.5	0.22	3.71	18	21	3.0	0.16	2.65

Bold = Optimal pressure for the MP Rotator is 2.8 bar; 280 kPa. This can easily be achieved by using the MP Rotator with the Pro-Spray PRS40, pressure-regulated at 2.8 bar; 280 kPa.

MP ROTATOR PERFORMANCE DATA

MP815

Radius: 2.5 to 4.9 m
Adjustable Arc and Full-Circle
● Maroon and Grey: 90° to 210°
● Lt. Blue and Grey: 210° to 270°
● Olive and Grey: 360°

Arc	Pressure		Radius	Flow		Precip. mm/hr	
	bar	kPa	m	m ³ /hr	l/min	■	▲
90° 	2.1	210	4.3	0.10	1.59	21	24
	2.5	250	4.5	0.10	1.74	21	24
	2.8	280	4.6	0.11	1.85	21	24
	3.1	310	4.8	0.12	1.97	21	24
	3.5	350	4.9	0.12	2.08	21	24
	3.8	380	4.9	0.13	2.20	22	25
180° 	2.1	210	4.0	0.17	2.84	21	25
	2.5	250	4.3	0.20	3.26	21	24
	2.8	280	4.5	0.21	3.52	21	24
	3.1	310	4.6	0.22	3.63	21	24
	3.5	350	4.8	0.24	4.01	21	24
	3.8	380	4.9	0.25	4.20	21	24
210° 	2.1	210	4.0	0.20	3.33	21	25
	2.5	250	4.3	0.22	3.63	20	23
	2.8	280	4.5	0.25	4.16	21	24
	3.1	310	4.6	0.26	4.39	21	25
	3.5	350	4.8	0.28	4.69	21	24
	3.8	380	4.9	0.30	4.92	21	24
270° 	2.1	210	4.0	0.26	4.31	22	25
	2.5	250	4.3	0.28	4.69	20	23
	2.8	280	4.5	0.32	5.30	21	24
	3.1	310	4.6	0.33	5.56	21	24
	3.5	350	4.8	0.35	5.83	20	23
	3.8	380	4.9	0.37	6.09	20	23
360° 	2.1	210	4.0	0.35	5.75	22	25
	2.5	250	4.3	0.39	6.43	21	24
	2.8	280	4.5	0.42	7.08	21	24
	3.1	310	4.6	0.45	7.57	21	25
	3.5	350	4.8	0.48	8.06	21	24
	3.8	380	4.9	0.51	8.55	21	25

MP STAKE

Models: **Standard and Pressure-Regulating Staking Kits**

Designed for easy implementation with any water-efficient MP Rotator Nozzle, MP Stake Kits come preassembled for quick installation in the field.

KEY BENEFITS

- Pair with any high-efficiency MP Rotator Nozzle to simplify temporary irrigation
- Preassembled for fast and easy installation in the field
- Standard kit includes a 66 cm stake, nozzle adapter, 0.345" (9 mm) tubing, and ½" threaded male fitting for quick connection
- For maximum water savings, upgrade to a 2.8 bar (280 kPa) pressure regulator and Hunter Check Valve

OPERATING SPECIFICATIONS

- Operational pressure range: 2.1 to 4.8 bar (210 to 480 kPa)

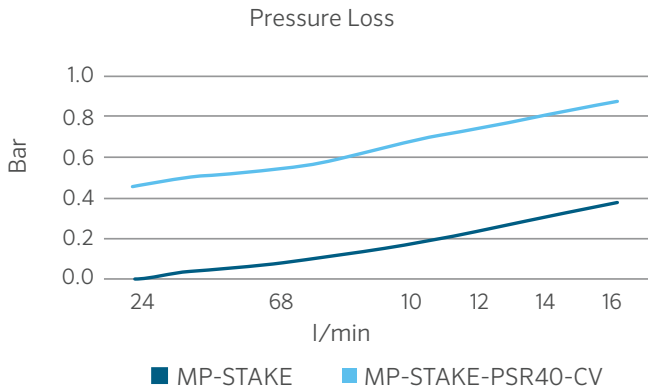

MP-STAKE

Total height: 71 cm
Male threaded connection: ½"

MP-STAKE-PSR40-CV

Total height: 86 cm
Male threaded connection: ½"

Compatible with:



All MP Rotator Nozzles
Page 54 and 58



Spray Nozzles
Page 74

MP-STAKE MODELS	
Model	Description
MP-STAKE	66 cm stake, 0.345" (9 mm) tubing to ½" male fitting, PROS-00 shrub adapter (total height: 71 cm)
MP-STAKE-PSR40-CV	66 cm stake, 0.345" (9 mm) tubing to ½" male fitting, Hunter Check Valve, PROS-00-PSR40 pressure-regulated shrub adapter (total height: 86 cm)

MP-STAKE-PSR40-CV Installation





ENGINEERED FOR *MAXIMUM EFFICIENCY*

DURABLE

With only one moving part, the MP Rotator is built with the highest-quality materials to ensure long-lasting performance in every installation.

FLEXIBLE

Matched precipitation across 1.5 m wide strips to 10.7 m radius allows the MP Rotator to fit a wide range of landscapes with uniform coverage for healthy plants.

EFFICIENT

The rotating streams of water cut through wind, reduce misting, and distribute water at a slow, even rate that soils can better absorb, preventing runoff.

RELIABLE

With more than 10 years of proven performance with Hunter Industries, the MP Rotator is the most trusted high-efficiency nozzle on the market.

SPRAYS & NOZZLES

SPRAYS

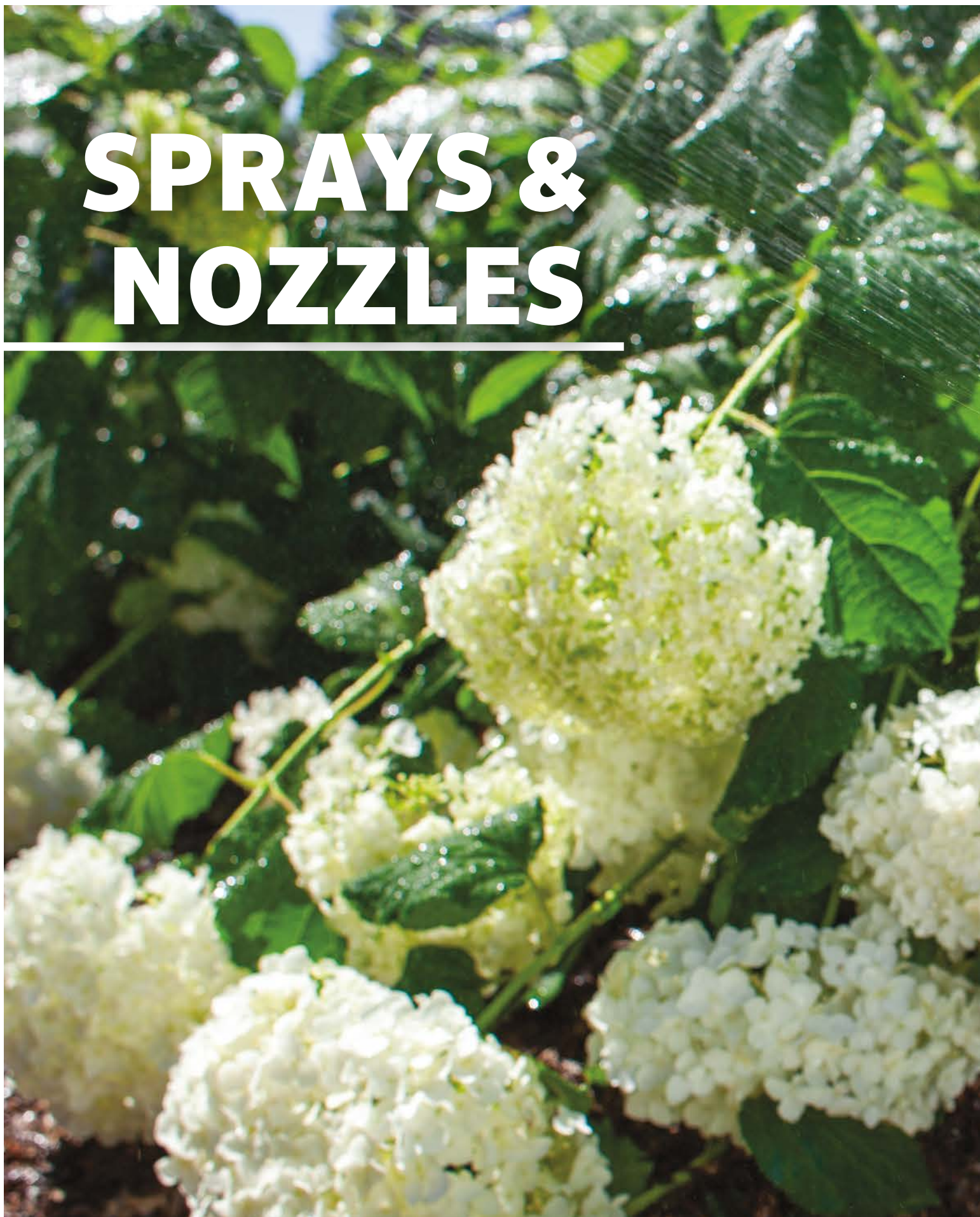



SPRAYS

ADVANCED FEATURES

STRENGTH & DURABILITY



CO-MOULDED WIPER SEAL

Moulded with two types of chemical- and chlorine-resistant materials, this multi-function wiper seal reduces flow-by, allowing more heads on one zone, and prevents debris from entering the seal, reducing riser stick-ups.

FLOGUARD™ TECHNOLOGY



In the event of a missing nozzle, FloGuard Technology reduces the flow of water from the riser to a 1.9 l/min (3 m tall) indicator stream, eliminating water waste and preventing landscape erosion while providing a visual indicator for repair.



HEAVY-DUTY SPRING

The industry's strongest spring offers positive retraction under any conditions.



CHECK VALVE

Optional field- or factory-installed check valves eliminate leaks and puddles at the lower heads, protecting landscapes from damage and erosion while reducing water waste.



PRESSURE-REGULATED TO 2.1 & 2.8 BAR

Pressure-regulated Pro-Spray Sprinkler Bodies optimise the performance of the nozzle, reducing flow rates and preventing misting. The PRS30 (brown) regulates pressures to 2.1 bar; 210 kPa for spray nozzles. The PRS40 (grey) is designed for the efficient MP Rotator Nozzle at 2.8 bar; 280 kPa.

INDUSTRY'S STRONGEST SPRAY BODY



The Pro-Spray line incorporates a heavy-duty ribbed body and durable cap engineered to withstand the harshest environments, including the rigors of foot traffic and the abuses of heavy machinery. In addition, the buttress thread design provides superior strength in cap-to-body gripping capacity, helping the head to withstand high inlet surge pressures.

PRO-SPRAY



COMPETITOR





INNOVATIVE SEAL DESIGN

Pedestrian traffic, landscape equipment, temperature changes, and cycling pressures can cause body caps to loosen. The Pro-Spray caps can withstand more than one full 360° turn and remain sealed at any pressure, preventing excess runoff.

Pro-Spray: Seal remains intact

Competitor: Significant leaking at the body cap

SPRAY BODY COMPARISON CHART

QUICK SPECS		 PS ULTRA	 PRO-SPRAY®	 PRS30	 PRS40
POP-UP HEIGHT	cm	Good 5, 10, 15	Better Shrub, 5, 7.5, 10, 15, 30	Best for Spray Nozzles Shrub, 10, 15, 30	Best for MP Rotator® Shrub, 10, 15, 30
PRESSURE-REGULATED	bar	N/A	N/A	2.1	2.8
	kPa	N/A	N/A	210	280
FEATURES					
PREINSTALLED NOZZLE		5SS, 8A, 10A, 12A, 15A, 17A	N/A	N/A	N/A
CAP COLOUR		Black	Black	Brown	Grey
CHECK VALVES		Field-Installed	Field-Installed or Factory-Installed	Field-Installed or Factory-Installed	Field-Installed or Factory-Installed
WARRANTY		2 Years	5 Years	5 Years	5 Years
ADVANCED FEATURES					
BODY STYLE		Slim Line	Rugged Body	Rugged Body	Rugged Body
SPRING		Standard	Heavy-Duty	Heavy-Duty	Heavy-Duty
CO-MOULDED WIPER SEAL			●	●	●
RECLAIMED CAP			●	●	●
PRESSURE REGULATION				●	●
FLOGUARD™ TECHNOLOGY				●	●
APPLICATIONS					
TURFGRASS		●	●	●	●
TURFGRASS: TALL MOWING HEIGHT		●	●	●	●
SHRUBS: SPRINKLERS ON RISERS			●	●	●
SHRUBS: TALL POP-UP SPRINKLERS			●	●	●
RESIDENTIAL		●	●	●	●
COMMERCIAL/MUNICIPALITIES			●	●	●
HIGH-TRAFFIC AREAS			●	●	●
RECLAIMED WATER			●	●	●

PS ULTRA

The PS Ultra is a compact, slim-line spray sprinkler with the option of preinstalled nozzles for faster installation.

KEY BENEFITS

- Enhanced cap for more durability, easier handling, and extended riser seal life
- Large inlet filter screen for increased debris resistance
- Check valve option eliminates low-head drainage
- Heavy-duty spring for consistent riser retraction

ADDITIONAL FEATURES

- Directional flush plug design for cleaner installation
- Two-piece ratcheting riser
- 5 cm and 10 cm models can retrofit into older style PS models
- Compatible with all female-threaded nozzles

OPERATING SPECIFICATIONS

- Operational pressure range: 1.4 to 4.8 bar; 140 to 480 kPa
- Warranty period: 2 years

FACTORY-INSTALLED OPTIONS

- Flush plug (large filter screen not included)
- Nozzles 2.4 m, 3.0 m, 3.7 m, 4.6 m, 5.2 m, 1.5 x 9.0 m side strip
- Large inlet filter screen included in 10 cm and 15 cm preinstalled nozzle models

USER-INSTALLED OPTIONS

- Check valve installs in filter screen for 10 cm and 15 cm models (up to 2 m of elevation; P/N 462237SP)
- Large inlet filter screen (P/N 162900SP)
- Shutoff nozzle (P/N 916400SP)



PSU-02

Retracted height: 12 cm
Pop-up height: 5 cm
Exposed diameter: 3 cm
Inlet size: ½"



PSU-04

Retracted height: 18 cm
Pop-up height: 10 cm
Exposed diameter: 3 cm
Inlet size: ½"



PSU-06

Retracted height: 24 cm
Pop-up height: 15 cm
Exposed diameter: 3 cm
Inlet size: ½"

PS ULTRA - SPECIFICATION BUILDER: ORDER 1 + 2 + 3 (OPTIONAL)

1 Model	2 Nozzles	3 Optional
PSU-02 = 5 cm pop-up	(blank) = Flush plug, no large filter screen	NFO = Nozzle filter only (available for 10 cm model only). Substitute standard installation of large inlet filter screen and receive unit with the nozzle filter only.
PSU-04 = 10 cm pop-up	8A = 2.4 m adjustable nozzle	
PSU-06 = 15 cm pop-up	10A = 3.0 m adjustable nozzle	
	12A = 3.7 m adjustable nozzle	
	15A = 4.6 m adjustable nozzle	
	17A = 5.2 m adjustable nozzle	
	5SS = 1.5 m x 9.1 m side strip (not available for PSU-06)	

Examples:

- PSU-04 - 15A = 10 cm pop-up, with a 4.6 m adjustable nozzle
- PSU-02 - 5SS = 5 cm pop-up, with a 1.5 m x 9.0 m side strip
- PSU-06 - 10A = 15 cm pop-up, with a 3.0 m adjustable nozzle
- PSU-04 - 12A - NFO = 10 cm pop-up, with a 3.7 m adjustable nozzle, nozzle filter only

PS ULTRA STANDARD NOZZLES PERFORMANCE DATA

8A 2.4 m radius
Adjustable from 0° to 360°
● Brown Trajectory: 15°

10A 3.0 m radius
Adjustable from 0° to 360°
● Red Trajectory: 15°

12A 3.7 m radius
Adjustable from 0° to 360°
● Green Trajectory: 28°







Arc	Pressure		Radius		Flow		Precip mm/hr		Radius		Flow		Precip mm/hr		Radius		Flow		Precip mm/hr																																																																					
	bar	kPa	m	m³/hr	l/min	■	▲	m	m³/hr	l/min	■	▲	m	m³/hr	l/min	■	▲	m	m³/hr	l/min	■	▲																																																																		
45° ▶	1.0	100	2.0	0.04	0.62	77	89	2.6	0.04	0.68	49	56	3.2	0.04	0.73	34	40	1.5	150	2.2	0.04	0.72	72	83	2.8	0.05	0.80	49	57	3.4	0.06	0.97	40	46	2.1	210	2.4	0.05	0.83	67	77	3.0	0.06	0.94	49	56	3.7	0.07	1.23	44	51	2.5	250	2.6	0.05	0.91	63	73	3.2	0.06	1.06	48	56	3.9	0.09	1.44	46	54	3.0	300	2.9	0.06	1.01	59	68	3.5	0.07	1.18	47	54	4.1	0.10	1.68	48	56			
	90° ◑	1.0	100	2.0	0.07	1.24	77	89	2.6	0.08	1.35	49	56	3.2	0.09	1.46	34	40	1.5	150	2.2	0.09	1.44	72	83	2.8	0.10	1.61	49	57	3.4	0.12	1.93	40	46	2.1	210	2.4	0.10	1.65	67	77	3.0	0.11	1.89	49	56	3.7	0.15	2.46	44	51	2.5	250	2.6	0.11	1.82	63	73	3.2	0.13	2.11	48	56	3.9	0.17	2.88	46	54	3.0	300	2.9	0.12	2.02	59	68	3.5	0.14	2.37	47	54	4.1	0.20	3.36	48	56		
		120° ◐	1.0	100	2.0	0.10	1.66	77	89	2.6	0.11	1.80	49	56	3.2	0.12	1.94	34	40	1.5	150	2.2	0.11	1.92	72	83	2.8	0.13	2.14	49	57	3.4	0.15	2.58	40	46	2.1	210	2.4	0.13	2.20	67	77	3.0	0.15	2.52	49	56	3.7	0.20	3.28	44	51	2.5	250	2.6	0.15	2.43	63	73	3.2	0.17	2.82	48	56	3.9	0.23	3.84	46	54	3.0	300	2.9	0.16	2.69	59	68	3.5	0.19	3.16	47	54	4.1	0.27	4.48	48	56	
			180° ◐	1.0	100	2.0	0.15	2.49	77	89	2.6	0.16	2.71	49	56	3.2	0.17	2.91	34	40	1.5	150	2.2	0.17	2.87	72	83	2.8	0.19	3.21	49	57	3.4	0.23	3.86	40	46	2.1	210	2.4	0.20	3.30	67	77	3.0	0.23	3.78	49	56	3.7	0.30	4.92	44	51	2.5	250	2.6	0.22	3.65	63	73	3.2	0.25	4.23	48	56	3.9	0.35	5.76	46	54	3.0	300	2.9	0.24	4.03	59	68	3.5	0.28	4.73	47	54	4.1	0.40	6.71	48	56
				240° ◑	1.0	100	2.0	0.20	3.32	77	89	2.6	0.22	3.61	49	56	3.2	0.23	3.88	34	40	1.5	150	2.2	0.23	3.83	72	83	2.8	0.26	4.28	49	57	3.4	0.31	5.15	40	46	2.1	210	2.4	0.26	4.40	67	77	3.0	0.30	5.03	49	56	3.7	0.39	6.56	44	51	2.5	250	2.6	0.29	4.86	63	73	3.2	0.34	5.64	48	56	3.9	0.46	7.68	46	54	3.0	300	2.9	0.32	5.38	59	68	3.5	0.38	6.31	47	54	4.1	0.54	8.95	48
270° ◑					1.0	100	2.0	0.22	3.73	77	89	2.6	0.24	4.06	49	56	3.2	0.26	4.37	34	40	1.5	150	2.2	0.26	4.31	72	83	2.8	0.29	4.82	49	57	3.4	0.35	5.80	40	46	2.1	210	2.4	0.30	4.95	67	77	3.0	0.34	5.66	49	56	3.7	0.44	7.38	44	51	2.5	250	2.6	0.33	5.47	63	73	3.2	0.38	6.34	48	56	3.9	0.52	8.65	46	54	3.0	300	2.9	0.36	6.05	59	68	3.5	0.43	7.10	47	54	4.1	0.60	10.07	48
	360° ●				1.0	100	2.0	0.30	4.97	77	89	2.6	0.32	5.41	49	56	3.2	0.35	5.83	34	40	1.5	150	2.2	0.34	5.75	72	83	2.8	0.39	6.43	49	57	3.4	0.46	7.73	40	46	2.1	210	2.4	0.40	6.61	67	77	3.0	0.45	7.55	49	56	3.7	0.59	9.84	44	51	2.5	250	2.6	0.44	7.29	63	73	3.2	0.51	8.45	48	56	3.9	0.69	11.53	46	54	3.0	300	2.9	0.48	8.07	59	68	3.5	0.57	9.47	47	54	4.1	0.81	13.43	48

Bold = Recommended pressure

PS ULTRA STANDARD NOZZLES PERFORMANCE DATA

15A 4.6 m radius
Adjustable from 0° to 360°
● Black Trajectory: 28°

17A 5.2 m radius
Adjustable from 0° to 360°
● Grey Trajectory: 28°

Arc	Pressure		Radius		Flow		Precip mm/hr		Radius		Flow		Precip mm/hr																																																		
	bar	kPa	m	m ³ /hr	l/min	■	▲	m	m ³ /hr	l/min	■	▲																																																			
45° 	1.0	100	4.0	0.08	1.27	38	43	4.6	0.10	1.68	38	43	1.5	150	4.3	0.09	1.51	39	45	4.9	0.12	1.94	38	44	2.1	210	4.6	0.11	1.79	40	46	5.2	0.13	2.23	39	45	2.5	250	4.9	0.12	2.00	40	46	5.5	0.15	2.46	39	45	3.0	300	5.2	0.14	2.25	40	46	5.8	0.16	2.72	39	45			
	90° 	1.0	100	4.0	0.15	2.53	38	43	4.6	0.20	3.36	38	43	1.5	150	4.3	0.18	3.03	39	45	4.9	0.23	3.88	38	44	2.1	210	4.6	0.21	3.57	40	46	5.2	0.27	4.45	39	45	2.5	250	4.9	0.24	4.01	40	46	5.5	0.30	4.92	39	45	3.0	300	5.2	0.27	4.50	40	46	5.8	0.33	5.44	39	45		
		120° 	1.0	100	4.0	0.20	3.38	38	43	4.6	0.27	4.48	38	43	1.5	150	4.3	0.24	4.03	39	45	4.9	0.31	5.17	38	44	2.1	210	4.6	0.29	4.76	40	46	5.2	0.36	5.94	39	45	2.5	250	4.9	0.32	5.34	40	46	5.5	0.39	6.56	39	45	3.0	300	5.2	0.36	6.00	40	46	5.8	0.43	7.25	39	45	
			180° 	1.0	100	4.0	0.30	5.07	38	43	4.6	0.40	6.71	38	43	1.5	150	4.3	0.36	6.05	39	45	4.9	0.47	7.75	38	44	2.1	210	4.6	0.43	7.14	40	46	5.2	0.53	8.91	39	45	2.5	250	4.9	0.48	8.02	40	46	5.5	0.59	9.83	39	45	3.0	300	5.2	0.54	9.00	40	46	5.8	0.65	10.87	39	45
				240° 	1.0	100	4.0	0.41	6.76	38	43	4.6	0.54	8.95	38	43	1.5	150	4.3	0.48	8.07	39	45	4.9	0.62	10.34	38	44	2.1	210	4.6	0.57	9.52	40	46	5.2	0.71	11.88	39	45	2.5	250	4.9	0.64	10.69	40	46	5.5	0.79	13.11	39	45	3.0	300	5.2	0.72	12.00	40	46	5.8	0.87	14.50	39
270° 					1.0	100	4.0	0.46	7.60	38	43	4.6	0.60	10.07	38	43	1.5	150	4.3	0.54	9.08	39	45	4.9	0.70	11.63	38	44	2.1	210	4.6	0.64	10.71	40	46	5.2	0.80	13.36	39	45	2.5	250	4.9	0.72	12.03	40	46	5.5	0.89	14.75	39	45	3.0	300	5.2	0.81	13.50	40	46	5.8	0.98	16.31	39
	360° 				1.0	100	4.0	0.61	10.13	38	43	4.6	0.81	13.43	38	43	1.5	150	4.3	0.73	12.10	39	45	4.9	0.93	15.51	38	44	2.1	210	4.6	0.86	14.28	40	46	5.2	1.07	17.82	39	45	2.5	250	4.9	0.96	16.03	40	46	5.5	1.18	19.67	39	45	3.0	300	5.2	1.08	18.00	40	46	5.8	1.30	21.75	39

Bold = Recommended pressure

STRIP PATTERN NOZZLE PERFORMANCE DATA

Model	Pressure		Width x Length m	Flow																					
	bar	kPa		m ³ /hr	l/min																				
 SS-530	1.0	100	1.2 x 8.5	0.21	3.5	1.5	150	1.5 x 9.0	0.25	4.2	2.0	200	1.5 x 9.0	0.29	4.9	2.1	210	1.5 x 9.1	0.30	5.0	2.5	250	1.5 x 9.1	0.33	5.5

Bold = Recommended pressure

PRO-SPRAY™

Meet the strongest, most versatile sprinkler body in the industry.

KEY BENEFITS

- Industry's strongest spray body for years of reliable performance
- Co-moulded wiper seal made from chemical- and chlorine-resistant materials
- Innovative seal design prevents cap-to-body leaks
- Heavy-duty spring for consistent riser retraction
- Check valve option eliminates low-head drainage

ADDITIONAL FEATURES

- Directional flush plug design for cleaner installation
- Interchangeable components for easier servicing, retrofits, and upgrades

OPERATING SPECIFICATIONS

- Operational pressure range: 1.0 to 7.0 bar; 100 to 700 kPa
- Warranty period: 5 years

FACTORY-INSTALLED OPTIONS

- Check valve available for 10 cm, 15 cm, and 30 cm models (up to 3 m of elevation)
- Reclaimed water ID cap

USER-INSTALLED OPTIONS

- Drain check valve (up to 3 m of elevation; P/N 437400SP)
- Reclaimed water ID cap (P/N 458520SP)
- Snap-on reclaimed cover (P/N PROS-RC-CAP-SP)
- Shutoff cap (P/N 213600SP)
- Shutoff nozzle (P/N 916400SP)



Pro-Spray Reclaimed

Pro-Spray models include optional factory-installed purple reclaimed caps.

PRO-SPRAY - SPECIFICATION BUILDER: ORDER 1 + 2

1 Model	2 Options
PROS-00 = Shrub adapter	(blank) = No option
PROS-02 = 5 cm pop-up	CV = Factory-installed drain check valve (Pop-up models only)
PROS-03 = 7.5 cm pop-up	R = Factory-installed reclaimed body cap (shrub moulded in purple)
PROS-04 = 10 cm pop-up	
PROS-06 = 15 cm pop-up (no side inlet)	
PROS-12 = 30 cm pop-up (no side inlet)	

PRO-SPRAY (SIDE INLET) MODELS

- PROS-06-SI** = 15 cm pop-up with side inlet
- PROS-12-SI** = 30 cm pop-up with side inlet

Examples:

- PROS-06-CV** = 15 cm pop-up, drain check valve
- PROS-12-CV-R** = 30 cm pop-up, drain check valve, reclaimed body cap



PROS-00

Retracted height: 4 cm
Inlet size: ½"



PROS-02

Retracted height: 10 cm
Pop-up height: 5 cm
Exposed diameter: 5.7 cm
Inlet size: ½"



PROS-03

Retracted height: 12.5 cm
Pop-up height: 7.5 cm
Exposed diameter: 5.7 cm
Inlet size: ½"



PROS-04

Retracted height: 15.5 cm
Pop-up height: 10 cm
Exposed diameter: 5.7 cm
Inlet size: ½"



[A] PROS-06-SI

[B] **PROS-06**
Retracted height: 22.5 cm
Pop-up height: 15 cm
Exposed diameter: 5.7 cm
Inlet size: ½"



[A] PROS-12-SI

[B] **PROS-12**
Retracted height: 41 cm
Pop-up height: 30 cm
Exposed diameter: 5.7 cm
Inlet size: ½"

PRS30

To maintain consistent performance and reduce water waste, the Pro-Spray PRS30 is pressure-regulated to an optimal pressure of 2.1 bar; 210 kPa.

KEY BENEFITS

- Industry's strongest spray body for years of reliable performance
- Pressure-regulated to 2.1 bar; 210 kPa for optimal nozzle performance
- Brown cap for easy field identification
- Co-moulded wiper seal made from chemical- and chlorine-resistant materials
- Innovative seal design prevents cap-to-body leaks, even with a loose cap
- FloGuard Technology option eliminates water waste in the event of a missing nozzle

ADDITIONAL FEATURES

- Directional flush plug design for cleaner installation
- Interchangeable components for easier servicing, retrofits, and upgrades
- Heavy-duty spring for consistent riser retraction
- Check valve option eliminates low-head drainage

OPERATING SPECIFICATIONS

- Operational pressure range: 1.0 to 7.0 bar; 100 to 700 kPa
- Warranty period: 5 years

FACTORY-INSTALLED OPTIONS

- Check valve available for 10 cm, 15 cm, and 30 cm models (up to 4.3 m of elevation)
- Reclaimed water identification
- FloGuard Technology available for check valve models

USER-INSTALLED OPTIONS

- Check valve (up to 4.3 m of elevation; P/N 437400SP)
- Reclaimed water ID cap (P/N 458560SP)
- Snap-on reclaimed cover (P/N PROS-RC-CAP-SP)
- Shutoff cap (P/N 213600SP)
- Shutoff nozzle (P/N 916400SP)



PRS30 Reclaimed

PRS30 models include optional factory-installed purple reclaimed caps.



PROS-00-PRS30
Retracted height: 11 cm
Inlet size: ½"



PROS-04-PRS30
Retracted height: 15.5 cm
Pop-up height: 10 cm
Exposed diameter: 5.7 cm
Inlet size: ½"



FloGuard Technology



[A] **PROS-06-SI-PRS30**
[B] **PROS-06-PRS30**
Retracted height: 22.5 cm
Pop-up height: 15 cm
Exposed diameter: 5.7 cm
Inlet size: ½"



[A] **PROS-12-SI-PRS30**
[B] **PROS-12-PRS30**
Retracted height: 41 cm
Pop-up height: 30 cm
Exposed diameter: 5.7 cm
Inlet size: ½"

PRO-SPRAY PRS30 - SPECIFICATION BUILDER: ORDER 1 + 2 + 3

1 Model	2 Feature Options	3 Specialty Options
PROS-00-PRS30 = 2.1 bar regulated shrub adapter	(blank) = No option	(blank) = No option
PROS-04-PRS30 = 2.1 bar regulated 10 cm pop-up	CV = Factory-installed drain check valve (pop-up models only)	R = Factory-installed reclaimed body cap
PROS-06-PRS30 = 2.1 bar regulated 15 cm pop-up		F = FloGuard Technology
PROS-12-PRS30 = 2.1 bar regulated 30 cm pop-up		F-R = FloGuard Technology with reclaimed body cap

PRO-SPRAY PRS30 (SIDE INLET) MODELS

PROS-06-SI-PRS30 = 2.1 bar regulated 15 cm pop-up with side inlet

PROS-12-SI-PRS30 = 2.1 bar regulated 30 cm pop-up with side inlet

Examples:

- PROS-06-SI-PRS30 = 15 cm pop-up with side inlet regulated at 2.1 bar; 210 kPa
- PROS-06-PRS30-CV = 15 cm pop-up regulated at 2.1 bar; 210 kPa, drain check valve
- PROS-12-PRS30-CV-F-R = 30 cm pop-up regulated at 2.1 bar; 210 kPa, drain check valve, and FloGuard Technology with reclaimed body cap

Compatible with:



Pro Adjustable Nozzles
Page 74
Pro-Spray Fixed Arc Nozzles
Page 78

PRS40

To optimise MP Rotator Nozzle performance, the Pro-Spray PRS40 is pressure-regulated to 2.8 bar; 280 kPa.

KEY BENEFITS

- Industry's strongest spray body for years of reliable performance
- Pressure-regulated to 2.8 bar; 280 kPa for the MP Rotator
- Grey cap for easy field identification
- Co-moulded wiper seal made from chemical- and chlorine-resistant materials
- Innovative seal design prevents cap-to-body leaks, even with a loose cap
- FloGuard Technology option eliminates water waste in the event of a missing nozzle

ADDITIONAL FEATURES

- Directional flush plug design for cleaner installation
- Interchangeable components for easier servicing, retrofits, and upgrades
- Heavy-duty spring for consistent riser retraction
- Check valve option eliminates low-head drainage

OPERATING SPECIFICATIONS

- Check valve available for 10 cm, 15 cm, and 30 cm models (up to 4.3 m of elevation)
- Operational pressure range: 1.0 to 7.0 bar; 100 to 700 kPa
- Warranty period: 5 years

FACTORY-INSTALLED OPTIONS

- Reclaimed water identification
- FloGuard Technology available for pop-up models

USER-INSTALLED OPTIONS

- Reclaimed water ID cap (P/N 458562SP)
- Snap-on reclaimed cover (P/N PROS-RC-CAP-SP)
- Shutoff cap (P/N 213600SP)
- Shutoff nozzle (P/N 916400SP)



PRS40 Reclaimed

PRS40 models include optional factory-installed purple reclaimed caps.



PROS-00-PRS40
Retracted height: 11 cm
Inlet size: ½"



PROS-04-PRS40-CV
Retracted height: 15.5 cm
Pop-up height: 10 cm
Exposed diameter: 5.7 cm
Inlet size: ½"



FloGuard Technology



PROS-06-PRS40-CV
Retracted height: 22.5 cm
Pop-up height: 15 cm
Exposed diameter: 5.7 cm
Inlet size: ½"



PROS-12-PRS40-CV
Retracted height: 41 cm
Pop-up height: 30 cm
Exposed diameter: 5.7 cm
Inlet size: ½"

PRO-SPRAY PRS40 – SPECIFICATION BUILDER: ORDER 1 + 2 + 3

1 Model	2 Feature Options	3 Specialty Options
PROS-00-PRS40 = 2.8 bar regulated shrub adapter PROS-04-PRS40 = 2.8 bar regulated 10 cm pop-up PROS-06-PRS40 = 2.8 bar regulated 15 cm pop-up PROS-12-PRS40 = 2.8 bar regulated 30 cm pop-up	(blank) = No option CV = Factory-installed drain check valve (<i>pop-up models only</i>)	(blank) = No option R = Factory-installed reclaimed body cap F = FloGuard Technology F-R = FloGuard Technology with reclaimed body cap

PRO-SPRAY PRS40 (SIDE INLET) MODELS

PROS-06-SI-PRS40 = 2.8 bar regulated 15 cm pop-up with side inlet

PROS-12-SI-PRS40 = 2.8 bar regulated 30 cm pop-up with side inlet

Examples:

PROS-06-SI-PRS40 = 15 cm pop-up with side inlet regulated at 2.8 bar; 280 kPa

PROS-06-PRS40-CV = 15 cm pop-up regulated at 2.8 bar; 280 kPa, drain check valve

PROS-12-PRS40-CV-F-R = 30 cm pop-up regulated at 2.8 bar; 280 kPa, drain check valve, and FloGuard Technology with reclaimed body cap

Compatible with:



MP Rotator Nozzles
Page 54 and Page 58

SPRAY ACCESSORIES

Spray accessories provide additional flexibility for installation and maintenance of spray systems.

SJ SWING JOINTS

Features

- Unique swivel ells on both ends for easy installation in any configuration
- Swing joints are built with air-tight connection points for long-term reliability

Models

- SJ-506: ½" threaded x 15 cm length
- SJ-512: ½" threaded x 30 cm length
- SJ-7506: ½" x ¾" threaded x 15 cm length
- SJ-7512: ½" x ¾" threaded x 30 cm length
- SJ-706: ¾" threaded x 15 cm length
- SJ-712: ¾" threaded x 30 cm length

Operating Specifications

- Pressure-rated to 10 bar; 1000 kPa
- Warranty period: 2 years



SJ Swing Joint

15 cm or 30 cm links

HUNTER SPIRAL BARB ELBOWS

Features

- Improved bigger, stronger design
- Spiral to barb design for easier installation
- Acetal material for sharp barbs
- Compatible with FlexSG and other brands for a customised swing joint

Models

- HSBE-050: ½" male x spiral barb elbow
- HSBE-075: ¾" male x spiral barb elbow

Operating Specifications

- Operating pressure: Up to 5.5 bar; 550 kPa
- Warranty period: 2 years



Spiral Barb Elbows

HSBE-050, HSBE-075

FLEXSG TUBING

Features

- Engineered to resist kinking
- Textured for easy grip
- Linear low-density polyethylene material
- Meets ASTM D2104, D2239, D2737

Models

- FLEXSG: 30 m roll
- FLEXSG-18: 45 cm pre-cut lengths

Operating Specifications

- Operating pressure: up to 5.5 bar; 550 kPa
- Warranty period: 2 years



FlexSG Tubing

30 m and 45 cm pre-cut lengths
Inside diameter: 1.2 cm

PRO-SPRAY SHUTOFF CAP

Features

- Caps off the Pro-Spray for maintenance or drip conversions
- Maintains a clean look to the landscape

Models

- 213600SP

SHUTOFF NOZZLE

Features

- Easy shutoff for spray systems
- Allows heads to pop-up for easy visibility
- Use with Pro-Spray and PS Ultra models

Models

- 916400SP



Pro-Spray Shutoff Cap

P/N 213600SP



Shutoff Nozzle

P/N 916400SP



NOZZLES

PRO ADJUSTABLE NOZZLES

Choose Pro Adjustable Nozzles for optimal landscape coverage in any setting.

KEY BENEFITS

- Adjustable from 0° to 360° for maximum design flexibility
- Easy-grip top for simple adjustment
- Strong edges for a defined pattern with better wind resistance
- Large water droplets minimise misting with better uniformity

ADDITIONAL FEATURES

- Matched precipitation rate on each nozzle from 8A to 17A
- Even distribution results in better coverage
- Colour-coded for easy field identification

OPERATING SPECIFICATIONS

- Recommended operating pressure: 2.1 bar; 210 kPa
- Pair with Pro-Spray PRS30 pop-up for pressure regulation to 2.1 bar; 210 kPa
- Warranty period: 2 years



4A Nozzle
Radius: 1.2 m



6A Nozzle
Radius: 1.8 m



8A Nozzle
Radius: 2.4 m



10A Nozzle
Radius: 3.0 m



12A Nozzle
Radius: 3.7 m



15A Nozzle
Radius: 4.6 m



17A Nozzle
Radius: 5.2 m

Pro Adjustable Nozzle



PRO ADJUSTABLE NOZZLES PERFORMANCE DATA



4A 1.2 m radius
Adjustable from 0° to 360°
● Lt. Green Trajectory: 0°

6A 1.8 m radius
Adjustable from 0° to 360°
● Lt. Blue Trajectory: 0°

8A 2.4 m radius
Adjustable from 0° to 360°
● Brown Trajectory: 15°

Arc	Pressure		Radius m	Flow		Precip mm/hr		Radius m	Flow		Precip mm/hr		Radius m	Flow		Precip mm/hr	
	bar	kPa		m ³ /hr	l/min	■	▲		m ³ /hr	l/min	■	▲		m ³ /hr	l/min	■	▲
45° ▶	1.0	100	0.9	0.02	0.31	187	216	1.5	0.03	0.54	117	136	2.0	0.04	0.62	77	89
	1.5	150	1.0	0.02	0.39	178	206	1.6	0.04	0.60	108	124	2.2	0.04	0.72	72	83
	2.1	210	1.2	0.03	0.48	167	193	1.8	0.04	0.65	98	114	2.4	0.05	0.83	67	77
	2.5	250	1.3	0.03	0.56	158	183	1.9	0.04	0.70	92	106	2.6	0.05	0.91	63	73
	3.0	300	1.4	0.04	0.64	149	172	2.1	0.05	0.75	86	99	2.9	0.06	1.01	59	68
90° ◑	1.0	100	0.9	0.04	0.72	213	246	1.5	0.06	1.08	116	134	2.0	0.07	1.24	77	89
	1.5	150	1.0	0.05	0.76	182	210	1.6	0.07	1.21	109	126	2.2	0.09	1.44	72	83
	2.1	210	1.2	0.05	0.83	139	160	1.8	0.08	1.35	102	118	2.4	0.10	1.65	67	77
	2.5	250	1.3	0.05	0.91	129	149	1.9	0.09	1.47	97	112	2.6	0.11	1.82	63	73
	3.0	300	1.4	0.06	0.95	116	134	2.1	0.10	1.61	92	106	2.9	0.12	2.02	59	68
120° ◐	1.0	100	0.9	0.06	0.97	221	255	1.5	0.08	1.26	102	118	2.0	0.10	1.66	77	89
	1.5	150	1.0	0.07	1.10	188	217	1.6	0.09	1.43	97	112	2.2	0.11	1.92	72	83
	2.1	210	1.2	0.07	1.25	162	187	1.8	0.10	1.61	91	105	2.4	0.13	2.20	67	77
	2.5	250	1.3	0.08	1.36	146	168	1.9	0.11	1.76	87	100	2.6	0.15	2.43	63	73
	3.0	300	1.4	0.09	1.49	131	151	2.1	0.12	1.93	82	95	2.9	0.16	2.69	59	68
180° ◓	1.0	100	0.9	0.07	1.18	178	206	1.5	0.10	1.70	92	106	2.0	0.15	2.49	77	89
	1.5	150	1.0	0.08	1.38	157	181	1.6	0.12	1.96	88	102	2.2	0.17	2.87	72	83
	2.1	210	1.2	0.10	1.60	139	160	1.8	0.13	2.24	84	97	2.4	0.20	3.30	67	77
	2.5	250	1.3	0.11	1.78	127	146	1.9	0.15	2.47	81	94	2.6	0.22	3.65	63	73
	3.0	300	1.4	0.12	1.98	115	133	2.1	0.16	2.72	78	90	2.9	0.24	4.03	59	68
240° ◒	1.0	100	0.9	0.12	1.94	220	254	1.5	0.15	2.44	99	114	2.0	0.20	3.32	77	89
	1.5	150	1.0	0.13	2.24	192	221	1.6	0.17	2.83	96	111	2.2	0.23	3.83	72	83
	2.1	210	1.2	0.16	2.59	168	194	1.8	0.20	3.28	92	107	2.4	0.26	4.40	67	77
	2.5	250	1.3	0.17	2.86	153	177	1.9	0.22	3.63	89	103	2.6	0.29	4.86	63	73
	3.0	300	1.4	0.19	3.17	139	160	2.1	0.24	4.03	86	99	2.9	0.32	5.38	59	68
270° ◑	1.0	100	0.9	0.13	2.09	211	244	1.5	0.18	3.08	111	128	2.0	0.22	3.73	77	89
	1.5	150	1.0	0.14	2.40	183	211	1.6	0.21	3.52	106	122	2.2	0.26	4.31	72	83
	2.1	210	1.2	0.16	2.75	159	183	1.8	0.24	4.02	101	116	2.4	0.30	4.95	67	77
	2.5	250	1.3	0.18	3.02	144	166	1.9	0.27	4.42	97	112	2.6	0.33	5.47	63	73
	3.0	300	1.4	0.20	3.33	130	150	2.1	0.29	4.87	92	107	2.9	0.36	6.05	59	68
360° ●	1.0	100	0.9	0.14	2.26	171	197	1.5	0.21	3.57	96	111	2.0	0.30	4.97	77	89
	1.5	150	1.0	0.16	2.60	148	171	1.6	0.24	4.07	92	106	2.2	0.34	5.75	72	83
	2.1	210	1.2	0.18	2.98	129	149	1.8	0.28	4.62	87	100	2.4	0.40	6.61	67	77
	2.5	250	1.3	0.20	3.29	117	135	1.9	0.30	5.06	83	96	2.6	0.44	7.29	63	73
	3.0	300	1.4	0.22	3.63	106	122	2.1	0.33	5.56	79	92	2.9	0.48	8.07	59	68

Bold = Recommended pressure

Note: The Pro-Spray PRS30's built-in pressure regulator controls output to a maximum of 2.1 bar; 210 kPa. Adjusting the radius reduction screw may be required to achieve catalogue radius and flow.

PRO ADJUSTABLE NOZZLES PERFORMANCE DATA



10A 3.0 m radius
Adjustable from 0° to 360°
● Red Trajectory: 15°



12A 3.7 m radius
Adjustable from 0° to 360°
● Green Trajectory: 28°



15A 4.6 m radius
Adjustable from 0° to 360°
● Black Trajectory: 28°

Arc	Pressure		Radius m	Flow		Precip mm/hr		Radius m	Flow		Precip mm/hr		Radius m	Flow		Precip mm/hr	
	bar	kPa		m ³ /hr	l/min	■	▲		m ³ /hr	l/min	■	▲		m ³ /hr	l/min	■	▲
45° ▶	1.0	100	2.6	0.04	0.68	49	56	3.2	0.04	0.73	34	40	4.0	0.08	1.27	38	43
	1.5	150	2.8	0.05	0.80	49	57	3.4	0.06	0.97	40	46	4.3	0.09	1.51	39	45
	2.1	210	3.0	0.06	0.94	49	56	3.7	0.07	1.23	44	51	4.6	0.11	1.79	40	46
	2.5	250	3.2	0.06	1.06	48	56	3.9	0.09	1.44	46	54	4.9	0.12	2.00	40	46
	3.0	300	3.5	0.07	1.18	47	54	4.1	0.10	1.68	48	56	5.2	0.14	2.25	40	46
90° ◐	1.0	100	2.6	0.08	1.35	49	56	3.2	0.09	1.46	34	40	4.0	0.15	2.53	38	43
	1.5	150	2.8	0.10	1.61	49	57	3.4	0.12	1.93	40	46	4.3	0.18	3.03	39	45
	2.1	210	3.0	0.11	1.89	49	56	3.7	0.15	2.46	44	51	4.6	0.21	3.57	40	46
	2.5	250	3.2	0.13	2.11	48	56	3.9	0.17	2.88	46	54	4.9	0.24	4.01	40	46
	3.0	300	3.5	0.14	2.37	47	54	4.1	0.20	3.36	48	56	5.2	0.27	4.50	40	46
120° ◑	1.0	100	2.6	0.11	1.80	49	56	3.2	0.12	1.94	34	40	4.0	0.20	3.38	38	43
	1.5	150	2.8	0.13	2.14	49	57	3.4	0.15	2.58	40	46	4.3	0.24	4.03	39	45
	2.1	210	3.0	0.15	2.52	49	56	3.7	0.20	3.28	44	51	4.6	0.29	4.76	40	46
	2.5	250	3.2	0.17	2.82	48	56	3.9	0.23	3.84	46	54	4.9	0.32	5.34	40	46
	3.0	300	3.5	0.19	3.16	47	54	4.1	0.27	4.48	48	56	5.2	0.36	6.00	40	46
180° ◒	1.0	100	2.6	0.16	2.71	49	56	3.2	0.17	2.91	34	40	4.0	0.30	5.07	38	43
	1.5	150	2.8	0.19	3.21	49	57	3.4	0.23	3.86	40	46	4.3	0.36	6.05	39	45
	2.1	210	3.0	0.23	3.78	49	56	3.7	0.30	4.92	44	51	4.6	0.43	7.14	40	46
	2.5	250	3.2	0.25	4.23	48	56	3.9	0.35	5.76	46	54	4.9	0.48	8.02	40	46
	3.0	300	3.5	0.28	4.73	47	54	4.1	0.40	6.71	48	56	5.2	0.54	9.00	40	46
240° ◓	1.0	100	2.6	0.22	3.61	49	56	3.2	0.23	3.88	34	40	4.0	0.41	6.76	38	43
	1.5	150	2.8	0.26	4.28	49	57	3.4	0.31	5.15	40	46	4.3	0.48	8.07	39	45
	2.1	210	3.0	0.30	5.03	49	56	3.7	0.39	6.56	44	51	4.6	0.57	9.52	40	46
	2.5	250	3.2	0.34	5.64	48	56	3.9	0.46	7.68	46	54	4.9	0.64	10.69	40	46
	3.0	300	3.5	0.38	6.31	47	54	4.1	0.54	8.95	48	56	5.2	0.72	12.00	40	46
270° ◔	1.0	100	2.6	0.24	4.06	49	56	3.2	0.26	4.37	34	40	4.0	0.46	7.60	38	43
	1.5	150	2.8	0.29	4.82	49	57	3.4	0.35	5.80	40	46	4.3	0.54	9.08	39	45
	2.1	210	3.0	0.34	5.66	49	56	3.7	0.44	7.38	44	51	4.6	0.64	10.71	40	46
	2.5	250	3.2	0.38	6.34	48	56	3.9	0.52	8.65	46	54	4.9	0.72	12.03	40	46
	3.0	300	3.5	0.43	7.10	47	54	4.1	0.60	10.07	48	56	5.2	0.81	13.50	40	46
360° ◕	1.0	100	2.6	0.32	5.41	49	56	3.2	0.35	5.83	34	40	4.0	0.61	10.13	38	43
	1.5	150	2.8	0.39	6.43	49	57	3.4	0.46	7.73	40	46	4.3	0.73	12.10	39	45
	2.1	210	3.0	0.45	7.55	49	56	3.7	0.59	9.84	44	51	4.6	0.86	14.28	40	46
	2.5	250	3.2	0.51	8.45	48	56	3.9	0.69	11.53	46	54	4.9	0.96	16.03	40	46
	3.0	300	3.5	0.57	9.47	47	54	4.1	0.81	13.43	48	56	5.2	1.08	18.00	40	46

Bold = Recommended pressure

Note: The Pro-Spray PRS30's built-in pressure regulator controls output to a maximum of 2.1 bar; 210 kPa. Adjusting the radius reduction screw may be required to achieve catalogue radius and flow.

PRO ADJUSTABLE NOZZLES PERFORMANCE DATA



17A 5.2 m radius
Adjustable from 0° to 360°
● Grey Trajectory: 28°

Arc	Pressure		Radius m	Flow		Precip mm/hr	
	bar	kPa		m ³ /hr	l/min	■	▲
45° ▶	1.0	100	4.6	0.10	1.68	38	43
	1.5	150	4.9	0.12	1.94	38	44
	2.1	210	5.2	0.13	2.23	39	45
	2.5	250	5.5	0.15	2.46	39	45
	3.0	300	5.8	0.16	2.72	39	45
90° ◑	1.0	100	4.6	0.20	3.36	38	43
	1.5	150	4.9	0.23	3.88	38	44
	2.1	210	5.2	0.27	4.45	39	45
	2.5	250	5.5	0.30	4.92	39	45
	3.0	300	5.8	0.33	5.44	39	45
120° ◐	1.0	100	4.6	0.27	4.48	38	43
	1.5	150	4.9	0.31	5.17	38	44
	2.1	210	5.2	0.36	5.94	39	45
	2.5	250	5.5	0.39	6.56	39	45
	3.0	300	5.8	0.43	7.25	39	45
180° ◕	1.0	100	4.6	0.40	6.71	38	43
	1.5	150	4.9	0.47	7.75	38	44
	2.1	210	5.2	0.53	8.91	39	45
	2.5	250	5.5	0.59	9.83	39	45
	3.0	300	5.8	0.65	10.87	39	45
240° ◔	1.0	100	4.6	0.54	8.95	38	43
	1.5	150	4.9	0.62	10.34	38	44
	2.1	210	5.2	0.71	11.88	39	45
	2.5	250	5.5	0.79	13.11	39	45
	3.0	300	5.8	0.87	14.50	39	45
270° ◓	1.0	100	4.6	0.60	10.07	38	43
	1.5	150	4.9	0.70	11.63	38	44
	2.1	210	5.2	0.80	13.36	39	45
	2.5	250	5.5	0.89	14.75	39	45
	3.0	300	5.8	0.98	16.31	39	45
360° ●	1.0	100	4.6	0.81	13.43	38	43
	1.5	150	4.9	0.93	15.51	38	44
	2.1	210	5.2	1.07	17.82	39	45
	2.5	250	5.5	1.18	19.67	39	45
	3.0	300	5.8	1.30	21.75	39	45

Bold = Recommended pressure

Note: The Pro-Spray PRS30's built-in pressure regulator controls output to a maximum of 2.1 bar; 210 kPa. Adjusting the radius reduction screw may be required to achieve catalogue radius and flow.

PRO-SPRAY™ FIXED ARC NOZZLES

Pro-Spray Fixed Arc Nozzles are designed for high accuracy within a variety of landscape shapes and sizes.

KEY BENEFITS

- Clean edges for a defined pattern with better wind resistance
- Large water droplets minimise misting with better uniformity
- Sturdy construction ensures reliable performance
- Colour-coded for easy field identification

OPERATING SPECIFICATIONS

- Recommended operating pressure: 2.1 bar; 210 kPa
- Pair with Pro-Spray PRS30 pop-up for pressure regulation to 2.1 bar; 210 kPa
- Warranty period: 2 years

PRO-SPRAY FIXED ARC NOZZLES						
ARC	5	8	10	12	15	17
Q						
T	Use 4A/6A Nozzle					Use 17A Nozzle
H						
TT	Use 4A/6A Nozzle	Use 8A Nozzle	Use 10A Nozzle			Use 17A Nozzle
TQ	Use 4A/6A Nozzle	Use 8A Nozzle	Use 10A Nozzle			Use 17A Nozzle
F						Use 17A Nozzle
	(1.5 m)	(2.4 m)	(3.0 m)	(3.7 m)	(4.6 m)	(5.2 m)

PRO-SPRAY FIXED ARC NOZZLES PERFORMANCE DATA



5 1.5 m radius
Fixed: ¼, ½, Full
● Blue Trajectory: 0°

8 2.4 m radius
Fixed: ¼, ½, Full
● Brown Trajectory: 15°

10 3.0 m radius
Fixed: ¼, ½, Full
● Red Trajectory: 15°

Arc	Position	Pressure		Radius m	Flow		Precip mm/hr		Radius m	Flow		Precip mm/hr		Radius m	Flow		Precip mm/hr				
		bar	kPa		m ³ /hr	l/min	■	▲		m ³ /hr	l/min	■	▲		m ³ /hr	l/min	■	▲			
90°	Q	1.0	100	1.1	0.02	0.30	60	69	1.8	0.04	0.62	46	53	2.4	0.07	1.08	45	52			
		1.5	150		0.02	0.38	54	62		2.1	0.05	0.84	46		53	2.7	0.08	1.33	44	51	
		2.1	210		0.03	0.46	49	57		2.4	0.05	0.91	38		44	3.0	0.09	1.57	42	48	
		2.5	250		0.03	0.51	42	49		2.7	0.06	0.98	32		37	3.3	0.10	1.71	38	44	
		3.0	300		0.03	0.53	39	45		2.7	0.06	1.10	36		42	3.4	0.11	1.85	38	44	
120°	T	1.0	100	1.1	0.04	0.60	60	69	1.8	0.05	0.83	46	53	2.4	0.09	1.44	45	52			
		1.5	150							Use 4A or 6A Nozzle	2.1	0.07	1.10		45	52	2.7	0.11	1.77	44	50
		2.1	210								2.4	0.07	1.21		38	44	3.0	0.13	2.09	42	48
		2.5	250								2.7	0.08	1.32		33	38	3.3	0.14	2.31	38	44
		3.0	300								2.7	0.09	1.44		36	41	3.4	0.15	2.50	39	45
180°	H	1.0	100	1.1	0.04	0.60	60	69	1.8	0.08	1.33	49	57	2.4	0.13	2.17	45	52			
		1.5	150	1.3	0.05	0.76	54	62	2.1	0.10	1.63	44	51	2.7	0.16	2.65	44	50			
		2.1	210	1.5	0.06	0.87	49	57	2.4	0.11	1.80	38	43	3.0	0.19	3.14	42	48			
		2.5	250	1.7	0.06	0.95	42	49	2.7	0.12	1.93	32	37	3.3	0.22	3.60	40	46			
		3.0	300	1.8	0.06	1.04	39	44	2.7	0.13	2.10	35	40	3.4	0.23	3.90	40	47			
240°	TT	1.0	100	1.1	0.04	0.60	60	69	1.8	0.08	1.33	49	57	2.4	0.13	2.17	45	52			
		1.5	150																Use 4A or 6A Nozzle	Use 8A Nozzle	Use 10A Nozzle
		2.1	210																		
		2.5	250																		
		3.0	300																		
270°	TQ	1.0	100	1.1	0.04	0.60	60	69	1.8	0.08	1.33	49	57	2.4	0.13	2.17	45	52			
		1.5	150																Use 4A or 6A Nozzle	Use 8A Nozzle	Use 10A Nozzle
		2.1	210																		
		2.5	250																		
		3.0	300																		
360°	F	1.0	100	1.1	0.07	1.20	60	69	1.8	0.16	2.67	49	57	2.4	0.26	4.33	45	52			
		1.5	150	1.3	0.09	1.52	54	62	2.1	0.20	3.33	45	52	2.7	0.32	5.31	44	50			
		2.1	210	1.5	0.11	1.85	49	57	2.4	0.22	3.67	38	44	3.0	0.38	6.28	42	48			
		2.5	250	1.7	0.12	2.04	42	49	2.7	0.24	4.01	33	38	3.3	0.41	6.85	38	44			
		3.0	300	1.8	0.12	2.10	39	45	2.7	0.26	4.35	36	41	3.4	0.42	6.97	36	42			

Bold = Recommended pressure

PRO-SPRAY FIXED ARC NOZZLES PERFORMANCE DATA



12 3.7 m radius
Fixed: ¼, ⅓, ½, ⅔, ¾, Full
● Green Trajectory: 28°

15 4.6 m radius
Fixed: ¼, ⅓, ½, ⅔, ¾, Full
● Black Trajectory: 28°

17 5.2 m radius
Fixed: ¼, ½
● Grey Trajectory: 28°

Arc	Position	Pressure		Radius m	Flow		Precip mm/hr		Radius m	Flow		Precip mm/hr		Radius m	Flow		Precip mm/hr	
		bar	kPa		m ³ /hr	l/min	■	▲		m ³ /hr	l/min	■	▲		m ³ /hr	l/min	■	▲
90°	Q	1.0	100	3.0	0.10	1.58	42	49	3.9	0.15	2.50	39	46	4.7	0.19	3.17	34	40
		1.5	150	3.4	0.12	2.00	42	48	4.2	0.18	3.06	42	48	4.9	0.23	3.88	39	45
		2.1	210	3.7	0.15	2.43	43	49	4.6	0.22	3.62	41	47	5.2	0.28	4.59	41	47
		2.5	250	4.0	0.16	2.69	40	47	4.9	0.24	3.95	39	46	5.5	0.30	5.01	40	46
		3.0	300	4.0	0.18	2.95	44	51	5.2	0.26	4.32	38	44	5.8	0.32	5.30	38	44
120°	T	1.0	100	3.0	0.13	2.11	42	49	3.9	0.20	3.33	39	46	Use 17A Nozzle				
		1.5	150	3.4	0.16	2.67	42	48	4.2	0.24	4.08	42	48					
		2.1	210	3.7	0.19	3.25	43	49	4.6	0.29	4.83	41	47					
		2.5	250	4.0	0.22	3.67	41	48	4.9	0.32	5.27	40	46					
		3.0	300	4.0	0.24	3.94	44	51	5.2	0.35	5.75	38	44					
180°	H	1.0	100	3.0	0.19	3.17	42	49	3.9	0.30	5.00	39	46	4.7	0.38	6.33	34	40
		1.5	150	3.4	0.24	4.01	42	48	4.2	0.37	6.12	42	48	4.9	0.47	7.76	39	45
		2.1	210	3.7	0.29	4.87	43	49	4.6	0.43	7.25	41	47	5.2	0.55	9.18	41	47
		2.5	250	4.0	0.32	5.39	40	47	4.9	0.47	7.91	40	46	5.5	0.60	10.01	40	46
		3.0	300	4.0	0.35	5.75	43	50	5.2	0.49	8.18	36	42	5.8	0.64	10.06	38	44
240°	TT	1.0	100	3.0	0.25	4.22	42	49	3.9	0.40	6.67	39	46	Use 17A Nozzle				
		1.5	150	3.4	0.32	5.34	42	48	4.2	0.49	8.16	42	48					
		2.1	210	3.7	0.39	6.49	43	49	4.6	0.58	9.66	41	47					
		2.5	250	4.0	0.43	7.18	40	47	4.9	0.63	10.54	40	46					
		3.0	300	4.0	0.46	7.68	43	50	5.2	0.65	10.90	36	42					
270°	TQ	1.0	100	3.0	0.29	4.75	42	49	3.9	0.45	7.50	39	46	Use 17A Nozzle				
		1.5	150	3.4	0.36	6.01	42	48	4.2	0.55	9.19	42	48					
		2.1	210	3.7	0.44	7.30	43	49	4.6	0.65	10.87	41	47					
		2.5	250	4.0	0.48	8.08	40	47	4.9	0.71	11.86	40	46					
		3.0	300	4.0	0.53	8.82	44	51	5.2	0.78	12.95	38	44					
360°	F	1.0	100	3.0	0.38	6.33	42	49	3.9	0.60	10.00	39	46	Use 17A Nozzle				
		1.5	150	3.4	0.48	8.01	42	48	4.2	0.73	12.25	42	48					
		2.1	210	3.7	0.58	9.74	43	49	4.6	0.87	14.49	41	47					
		2.5	250	4.0	0.65	10.78	40	47	4.9	0.95	15.81	40	46					
		3.0	300	4.0	0.70	11.73	44	51	5.2	0.99	16.50	37	42					

Bold = Recommended pressure

SHORT-RADIUS MICRO SPRAY NOZZLES

These highly accurate nozzles are perfect for small spaces and can support a robust micro spray system with Pro-Spray Sprinkler Bodies.

KEY BENEFITS



- Low flow for controlled irrigation of tight spaces
- Meets micro spray requirement of 114 l/hr max flow at 2.1 bar; 210 kPa
- Built to last for a robust overhead solution for small spaces

OPERATING SPECIFICATIONS



- Recommended operating pressure: 2.1 bar; 210 kPa
- Pair with Pro-Spray PRS30 pop-up for pressure regulation to 2.1 bar; 210 kPa

SHORT-RADIUS NOZZLES PERFORMANCE DATA



● Nozzle Lt. Brown

Arc	Pressure		Position	Radius m	Flow		*Precip mm/hr
	bar	kPa			l/min	l/hr	
90° 	1.0	100	2Q	0.6	0.34	20	57
	1.5	150		0.6	0.38	23	63
	2.1	210		0.6	0.42	25	70
	2.5	250		0.6	0.49	29	82
180° 	1.0	100	2H	0.6	0.53	32	44
	1.5	150		0.6	0.57	34	48
	2.1	210		0.6	0.76	46	63
	2.5	250		0.6	0.77	46	64
				0.6	0.80	48	67

● Nozzle Lt. Green

Arc	Pressure		Position	Radius m	Flow		*Precip mm/hr
	bar	kPa			l/min	l/hr	
90° 	1.0	100	4Q	1.2	0.68	41	28
	1.5	150		1.2	0.76	46	32
	2.1	210		1.2	0.76	46	32
	2.5	250		1.2	0.83	50	35
180° 	1.0	100	4H	1.2	1.25	75	26
	1.5	150		1.2	1.29	77	27
	2.1	210		1.2	1.51	91	31
	2.5	250		1.2	1.52	91	32
				1.2	1.67	100	35

● Nozzle Lt. Blue

Arc	Pressure		Position	Radius m	Flow		*Precip mm/hr
	bar	kPa			l/min	l/hr	
90° 	1.0	100	6Q	1.8	0.83	50	15
	1.5	150		1.8	0.91	55	17
	2.1	210		1.8	1.14	68	21
	2.5	250		1.8	1.14	68	21
180° 	1.0	100	6H	1.8	1.52	91	14
	1.5	150		1.8	1.67	100	15
	2.1	210		1.8	1.90	114	18
	2.5	250		1.8	1.97	118	18
				1.8	2.05	123	19

Bold = Recommended pressure

*Precipitation rate shown without overlap



2Q Nozzle
Radius: 0.6 m



2H Nozzle
Radius: 0.6 m



4Q Nozzle
Radius: 1.2 m



4H Nozzle
Radius: 1.2 m



6Q Nozzle
Radius: 1.8 m



6H Nozzle
Radius: 1.8 m

Short-Radius Micro Spray Nozzle



STRIP PATTERN NOZZLES

Irrigate narrow turf and planter areas accurately with fixed arc Strip Pattern Nozzles.

KEY BENEFITS

- Designed for accurate coverage of strip areas
- Available in a variety of models for unique, rectangular spaces
- Built to last in harsh conditions

OPERATING SPECIFICATIONS

- Recommended operating pressure: 2.1 bar; 210 kPa
- Pair with Pro-Spray PRS30 pop-up for pressure regulation to 2.1 bar; 210 kPa
- Warranty period: 2 years



Left Corner Strip
Rectangle: 1.5 m x 4.5 m



Right Corner Strip
Rectangle: 1.5 m x 4.5 m



Side Strip
Rectangle: 1.5 m x 9.1 m



Side Strip
Rectangle: 2.7 m x 5.5 m









Center Strip
Rectangle: 1.5 m x 9.1 m



End Strip
Rectangle: 1.5 m x 4.5 m

STRIP PATTERN NOZZLE PERFORMANCE DATA

Arc	Pressure		Width x Length m	Flow	
	bar	kPa		m ³ /hr	l/min
LCS-515 	1.0	100	1.2 x 4.2	0.10	1.7
	1.5	150	1.2 x 4.3	0.13	2.1
	2.1	210	1.5 x 4.5	0.15	2.5
	2.5	250	1.5 x 4.5	0.16	2.7
	3.0	300	1.5 x 4.5	0.17	2.8
RCS-515 	1.0	100	1.2 x 4.2	0.10	1.7
	1.5	150	1.2 x 4.3	0.13	2.1
	2.1	210	1.5 x 4.5	0.15	2.5
	2.5	250	1.5 x 4.5	0.16	2.7
SS-530 	1.0	100	1.2 x 8.5	0.21	3.5
	1.5	150	1.5 x 9.0	0.25	4.2
	2.1	210	1.5 x 9.1	0.30	5.0
	2.5	250	1.5 x 9.1	0.33	5.5
SS-918 	1.0	100	2.4 x 5.2	0.27	4.5
	1.5	150	2.7 x 5.5	0.33	5.5
	2.1	210	2.7 x 5.5	0.39	6.5
	2.5	250	2.7 x 5.5	0.43	7.1
CS-530 	1.0	100	1.2 x 8.5	0.21	3.5
	1.5	150	1.5 x 9.0	0.25	4.2
	2.1	210	1.5 x 9.1	0.30	5.0
	2.5	250	1.5 x 9.1	0.33	5.5
ES-515 	1.0	100	1.1 x 4.2	0.10	1.7
	1.5	150	1.2 x 4.3	0.13	2.1
	2.1	210	1.5 x 4.5	0.15	2.5
	2.5	250	1.5 x 4.5	0.16	2.7
	3.0	300	1.5 x 4.5	0.17	2.8

Bold = Recommended pressure

RCS-515



NOZZLES

STREAM NOZZLES

Prevent runoff for slope, groundcover, and shrub applications with the low precipitation rate of these adjustable arc Stream Nozzles.



KEY BENEFITS

- Low application rate to avoid runoff
- Ideal for slopes, ground cover, and shrub applications
- Multiple streams provide even coverage
- Adjustable arc from 25° to 360° for design flexibility

OPERATING SPECIFICATIONS



- Recommended operating pressure: 2.1 bar; 210 kPa
- Pair with Pro-Spray PRS30 pop-up for pressure regulation to 2.1 bar; 210 kPa
- Warranty period: 2 years

MODEL S-8A STREAM SPRAY NOZZLE PERFORMANCE DATA

Arc	Pressure		Radius m	Flow		Precip mm/hr	
	bar	kPa		m ³ /hr	l/min	■	▲
90° 	1.0	100	2.1	0.05	0.9	49	57
	1.5	150	2.2	0.07	1.1	55	63
	2.1	210	2.4	0.09	1.4	58	67
	2.5	250	2.6	0.10	1.6	57	66
	3.0	300	2.7	0.12	2.0	66	76
180° 	1.0	100	2.1	0.12	1.9	52	60
	1.5	150	2.2	0.13	2.1	52	60
	2.1	210	2.4	0.14	2.3	48	55
	2.5	250	2.6	0.15	2.4	43	49
	3.0	300	2.7	0.15	2.5	41	48
360° 	1.0	100	2.1	0.24	4.0	54	63
	1.5	150	2.2	0.25	4.2	52	60
	2.1	210	2.4	0.26	4.4	46	53
	2.5	250	2.6	0.27	4.5	40	46
	3.0	300	2.7	0.28	4.6	38	44

Bold = Recommended pressure

MODEL S-16A STREAM SPRAY NOZZLE PERFORMANCE DATA

Arc	Pressure		Radius m	Flow		Precip mm/hr	
	bar	kPa		m ³ /hr	l/min	■	▲
90° 	1.0	100	4.3	0.08	1.4	18	21
	1.5	150	4.6	0.10	1.6	18	21
	2.1	210	5.0	0.11	1.9	18	21
	2.5	250	5.3	0.12	2.1	18	21
	3.0	300	5.5	0.13	2.2	17	20
180° 	1.0	100	4.3	0.14	2.3	15	17
	1.5	150	4.6	0.17	2.8	16	18
	2.1	210	5.0	0.20	3.4	16	19
	2.5	250	5.3	0.23	3.8	16	19
	3.0	300	5.5	0.24	4.0	16	18
360° 	1.0	100	4.3	0.23	3.9	13	15
	1.5	150	4.6	0.30	5.0	14	16
	2.1	210	5.0	0.38	6.3	15	17
	2.5	250	5.3	0.43	7.2	15	18
	3.0	300	5.5	0.45	7.5	15	17

Bold = Recommended pressure



S-8A
Radius: 2.1 m to 2.6 m



S-16A
Radius: 4.3 m to 5.3 m

S-8A

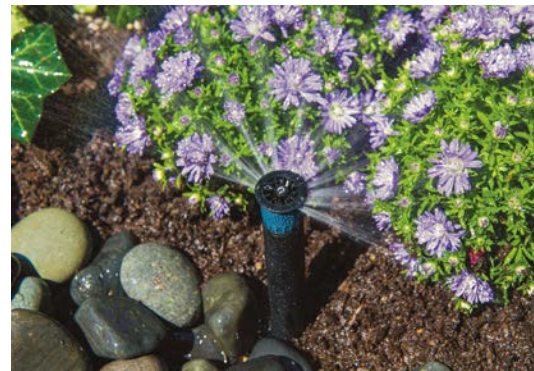



BUBBLER NOZZLES

Deliver a consistent flow regardless of inlet pressure with pressure-compensating Bubbler Nozzles.

KEY BENEFITS

- Pressure-compensating for constant water flow at any pressure
- Designed for deep watering of planted areas
- Nozzle threaded for use with Pro-Spray
- Warranty period: 2 years

MULTI-STREAM BUBBLER PERFORMANCE DATA

Arc	Model	Flow		Radius m
		m ³ /hr	l/min	
	MSBN-25Q	0.06	0.9	0.30
	MSBN-50Q	0.11	1.9	0.46
	MSBN-50H	0.11	1.9	0.30
	MSBN-10H	0.23	3.8	0.46
	MSBN-10F	0.23	3.8	0.30
	MSBN-20F	0.45	7.6	0.46

Multi-Stream Bubbler



Notes:

Typical spacing 0.6 to 1.2 m. Flows shown for pressures between 1.0 and 4.8 bar; 100 and 480 kPa.



MSBN Installed on PROS-04

Combining Hunter Bubbler Nozzles with the Pro-Spray provides the watering precision of pressure-compensating bubblers paired with the benefit of retracting the nozzle out of sight.

PCN PERFORMANCE DATA

	Model	Flow		Pattern Type
		m ³ /hr	l/min	
	25	0.06	0.9	Trickle
	50	0.11	1.9	Trickle
	10	0.23	3.8	Umbrella
	20	0.46	7.6	Umbrella

PCN



Notes:

Typical spacing 0.3 to 0.9 m. Flows shown for pressures between 1.0 and 4.8 bar; 100 and 480 kPa.

5-CST-B BUBBLER NOZZLE PERFORMANCE DATA

	Pressure		Radius m	Flow	
	bar	kPa		m ³ /hr	l/min
	1.0	100	1.5	0.07	1.1
	1.5	150	1.5	0.07	1.2
	2.0	200	1.5	0.09	1.4
	2.1	210	1.5	0.09	1.5
	2.5	250	1.5	0.10	1.6

5-CST-B



MULTI-STREAM BUBBLER NOZZLES



MSBN-25Q
Flow: 0.06 m³/hr;
0.9 l/min



MSBN-50Q/50H
Flow: 0.11 m³/hr;
1.9 l/min



MSBN-10H/10F
Flow: 0.23 m³/hr;
3.8 l/min



MSBN-20F
Flow: 0.45 m³/hr;
7.6 l/min

PCN BUBBLER NOZZLES



PCN-25
Flow: 0.06 m³/hr;
0.9 l/min



PCN-50
Flow: 0.11 m³/hr;
1.9 l/min



PCN-10
Flow: 0.23 m³/hr;
3.8 l/min



PCN-20
Flow: 0.46 m³/hr;
7.6 l/min

DUAL-STREAM BUBBLER NOZZLE



5-CST-B

NOZZLES

BUBBLERS

Ensure consistent flow regardless of pressure with above-ground, pressure-compensating Bubblers.

KEY BENEFITS

- Pressure-compensating for constant water flow at any pressure
- Designed for deep watering of planted areas
- ½" threaded inlet for easy installation on a ½" riser
- Warranty period: 2 years

PCB PERFORMANCE DATA

	Model	Flow		Pattern Type
		m ³ /hr	l/min	
	25	0.06	0.9	Trickle
	50	0.11	1.9	Trickle
	10	0.23	3.8	Umbrella
	20	0.45	7.6	Umbrella

Notes:

Typical spacing 0.6 to 1.2 m. Flows shown for pressures between 1.0 and 4.8 bar; 100 and 480 kPa.

PCB



PRESSURE-COMPENSATING BUBBLERS



PCB



PCB-R

AFB PERFORMANCE DATA

	Model	Flow		Pattern Type
		m ³ /hr	l/min	
	AFB	< 0.45	< 7.6	Trickle/ Umbrella

AFB



ADJUSTABLE FLOOD BUBBLER



AFB



VALVES



Look for this icon. All Hunter valves are 100% water-tested to ensure reliable operation once installed.

VALVE COMPARISON CHART

QUICK SPECS		1" PGV & JAR-TOP	PGV	ICV	ICV FILTER SENTRY	IBV FILTER SENTRY
SIZE		1" BSP (25 mm)	1½", 2" BSP (40, 50 mm)	1", 1½", 2", 3" BSP (25, 40, 50, 80 mm)	1", 1½", 2", 3" BSP (25, 40, 50, 80 mm)	1", 1½", 2", 3" BSP (25, 40, 50, 80 mm)
FLOW	(m³/hr)	0.05-9	0.05-34	0.05-68	0.05-68	0.05-68
	(l/min)	0.7-150	0.7-570	0.4-1135	0.4-1135	0.4-1135

FEATURES

CAPTIVE BONNET BOLTS		●	●	●	●	
EPDM DIAPHRAGM AND SEAT				Standard	Standard	Standard
WARRANTY		2 Years	2 Years	5 Years	5 Years	5 Years

ADVANCED FEATURES

FLOW CONTROL	Optional	●	●	●	●	
FILTER SENTRY™ MECHANISM				User-Installed	Factory-Installed	Factory-Installed
ACCU SYNC™ CAPABLE		●	●	●	●	●
RECLAIMED WATER ID HANDLE	User-Installed	User-Installed	User-Installed	User-Installed	User-Installed	
RECLAIMED WATER ID TAG				User-Installed	User-Installed	User-Installed

APPLICATIONS

RESIDENTIAL	●	●	●			
COMMERCIAL		●	●		●	●
POTABLE WATER	●	●	●		●	●
RECLAIMED WATER			●		●	●
SECONDARY WATER					●	●
PRESSURE REGULATION	●	●	●		●	●
HIGH-PRESSURE SYSTEMS			●		●	●
LOW-PRESSURE SYSTEMS	●	●	●		●	●
HIGH-TEMPERATURE LOCATIONS			●		●	●
USE AS MASTER VALVE		●	●		●	●

Advanced Features



ACCU SYNC PRESSURE REGULATORS

Available on:
PGV, ICV, IBV

Avoid sprinkler over-pressure conditions and gain significant water savings with Accu Sync Pressure Regulators. This option is available in adjustable or fixed pressure models.



FILTER SENTRY MECHANISM

For use with:
ICV, IBV

The Filter Sentry Mechanism scours the filter clean twice during each valve cycle. Since it is attached to the diaphragm, the Filter Sentry feature can be easily added after a valve has been installed.



1½" AND 2" PGV

These reliable valves provide long-lasting performance for larger systems.

KEY BENEFITS

- External/internal manual bleed allows for quick and easy activation at the valve
- Double-beaded diaphragm seal design ensures leak-free performance
- Captive bonnet screws eliminate the possibility of lost parts during disassembly
- Flow control maximises efficiency and prolongs the life of the system
- Triple-tool bonnet screws are compatible with standard or Phillips screwdrivers as well as a nut driver
- Each valve available with globe or angle configuration for convenient placement
- Encapsulated solenoid with captive plunger used on every Hunter valve provides hassle-free service

USER-INSTALLED OPTIONS

- Accu Sync™ Pressure Regulator at the valve*
- DC-Latching Solenoid for battery-operated controllers (P/N 458200)
- Reclaimed flow control handle (P/N 607105)

FACTORY-INSTALLED OPTIONS

- DC: DC-Latching Solenoid for battery-operated controllers; see page 261
- LS: Valve without solenoid

OPERATING SPECIFICATIONS

- Flow:
 - PGV-151: 5 to 27 m³/hr; 75 to 450 l/min
 - PGV-201: 5 to 34 m³/hr; 75 to 570 l/min
- Recommended pressure range: 1.5 to 10 bar; 150 to 1000 kPa
- Temperature rating: 66°C
- Warranty period: 2 years

SOLENOID SPECIFICATIONS

- 24 VAC solenoid
 - 350 mA inrush, 190 mA holding, 60 Hz
 - 370 mA inrush, 210 mA holding, 50 Hz

* Accu Sync product information on page 98



PGV-151
Inlet diameter: 1½" (40 mm)
Height: 19 cm
Length: 15 cm
Width: 11 cm

PGV-201
Inlet diameter: 2" (50 mm)
Height: 20 cm
Length: 17 cm
Width: 13 cm

VALVES

PGV Installed



PGV PRESSURE LOSS IN kPa

Flow l/min	1½" (40 mm) Globe	1½" (40 mm) Angle	2" (50 mm) Globe	2" (50 mm) Angle
75	20	22	4	9
95	20	21	5.5	9
115	21	21	7.5	9.5
135	22	21	9	10
150	25	23	12	11
200	27	24	14	12
325	47	41	26	19
400	65	59	33	24
500	96	92	43	32
625			56	45
775			74	64

PGV PRESSURE LOSS IN BAR

Flow m³/hr	1½" (40 mm) Globe	1½" (40 mm) Angle	2" (50 mm) Globe	2" (50 mm) Angle
4.5	0.2	0.2	0.1	0.1
5.5	0.2	0.2	0.1	0.1
6.5	0.2	0.2	0.1	0.1
8.0	0.2	0.2	0.1	0.1
9.0	0.2	0.2	0.1	0.1
11.0	0.3	0.2	0.1	0.1
13.5	0.3	0.3	0.1	0.1
18.0	0.4	0.4	0.2	0.1
22.5	0.6	0.5	0.3	0.2
27.0	0.8	0.8	0.4	0.3
30.5			0.6	0.5
34.0			0.7	0.6

PGV 1½" & 2" - SPECIFICATION BUILDER: ORDER 1 + 2 + 3 + 4			
1 Model	2 Standard Features	3 Feature Options	4 User-Installed Options
<p>PGV-151-B = 1½" (40 mm) BSP</p> <p>PGV-201-B = 2" (50 mm) BSP</p>	Globe / Angle valve with flow control	<p>(blank) = No option</p> <p>DC = DC-Latching Solenoid battery-operated controllers</p> <p>LS = Less solenoid</p>	<p>AS-ADJ = Accu Sync adjustable</p> <p>458200 = DC-Latching Solenoid for battery-operated controllers</p> <p>607105 = Reclaimed flow control handle</p> <p>LIT-700 = Reclaimed ID tag</p>

Examples:
PGV-201-B-AS-ADJ = 2" (50 mm) BSP PGV globe/angle valve with flow control, user-installed Accu Sync Pressure Regulator

1" PGV AND PGV JAR-TOP



These versatile and robust valves offer simple serviceability.

KEY BENEFITS

- External/internal manual bleed allows for quick and easy activation at the valve
- Double-beaded diaphragm seal design ensures leak-free performance
- Captive bonnet screws eliminate the possibility of lost parts during disassembly
- Triple-tool bonnet screws are compatible with standard or Phillips screwdrivers as well as a nut driver
- Jar-top models provide easy access without tools
- Encapsulated solenoid with captive plunger used on every Hunter valve provides hassle-free service
- Flow control maximises efficiency and prolongs the life of the system

USER-INSTALLED OPTIONS

- Accu Sync™ Pressure Regulator at the valve*
- DC-Latching Solenoid for battery-operated controllers (P/N 458200)

FACTORY-INSTALLED OPTIONS

- LS: Valve without solenoid
- DC: DC-Latching Solenoid for battery-operated controllers; **see page 261**
- JT: Jar-top models

OPERATING SPECIFICATIONS

- Flow: 0.05 to 9 m³/hr; 0.7 to 150 l/min
- Recommended pressure range: 1.5 to 10 bar; 150 to 1000 kPa
- Temperature rating: 66°C
- Warranty period: 2 years

SOLENOID SPECIFICATIONS

- 24 VAC solenoid
 - 350 mA inrush, 190 mA holding, 60 Hz
 - 370 mA inrush, 210 mA holding, 50 Hz

* Accu Sync product information on **page 98**



PGV-100G
Inlet diameter: 1" (25 mm)
Height: 13 cm
Length: 11 cm
Width: 6 cm



PGV-101G
Inlet diameter: 1" (25 mm)
Height: 13 cm
Length: 11 cm
Width: 6 cm



PGV-100JT-G
Inlet diameter: 1" (25 mm)
Height: 14 cm
Length: 11 cm
Width: 8 cm



PGV-101JT-G
Inlet diameter: 1" (25 mm)
Height: 14 cm
Length: 11 cm
Width: 8 cm

Double-Beaded Diaphragm



AC Solenoid
(P/N 606800)
Two red wires



DC-Latching Solenoid
(P/N 458200)
One black (common) wire
and one red (station) wire

PGV - SPECIFICATION BUILDER : ORDER 1 + 2 + 3 + 4 + 5

1 Model	2 Standard Features	3 Feature Options	4 Options	5 User-Installed Options
PGV-100 = 1" (25 mm)	Globe valve, without flow control, threaded inlet/outlet	G-B = BSP female threaded inlet/outlet	DC = DC-Latching Solenoid for battery-operated controllers	AS-ADJ = Accu Sync adjustable
PGV-101 = 1" (25 mm)	Globe valve, with flow control, threaded inlet/outlet	MM-B = BSP male threaded inlet/outlet	LS = Less solenoid	458200 = DC-Latching Solenoid for battery-operated controllers 269205 = Reclaimed flow control handle LIT-700 = Reclaimed ID tag

Example:

PGV-101-G-B-DC = 1" (25 mm) PGV globe valve, with flow control, with female BSP inlet and outlet, with DC-Latching Solenoid

PGV JAR-TOP - SPECIFICATION BUILDER : ORDER 1 + 2 + 3 + 4 + 5

1 Model	2 Standard Features	3 Feature Options	4 Options	5 User-Installed Options
PGV-100-JT = 1" (25 mm)	Globe valve, jar-top bonnet, without flow control, threaded inlet/outlet	G-B = BSP female threaded inlet/outlet	DC = DC-Latching Solenoid for battery-operated controllers	AS-ADJ = Accu Sync adjustable
PGV-101-JT = 1" (25 mm)	Globe valve, jar-top bonnet, with flow control, threaded inlet/outlet	MM-B = BSP male threaded inlet/outlet	LS = Less solenoid	458200 = DC-Latching Solenoid for battery-operated controllers 269205 = Reclaimed flow control handle LIT-700 = Reclaimed ID tag

Example:

PGV-101-JT-MM-B-DC = 1" (25 mm) PGV globe valve, with jar-top bonnet, with flow control, with male BSP inlet and outlet, with DC-Latching Solenoid

1" (25 MM) PGV VALVE	
Flow m ³ /hr	Pressure Loss bar
0.3	0.08
1.0	0.11
2.5	0.13
3.5	0.16
4.5	0.23
5.5	0.43
6.5	0.62
8.0	1.10
9.0	1.48

1" (25 MM) PGV VALVE	
Flow l/min	Pressure Loss kPa
4	8
20	11
40	13
55	16
75	23
95	43
115	62
135	110
150	148

PGV-100G Installed

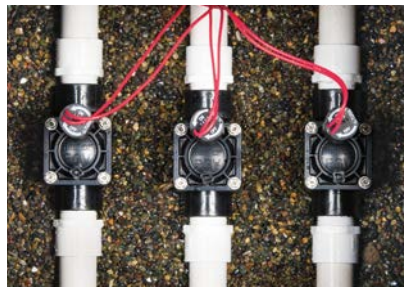

Captive Bonnet Bolts



This valve is the perfect choice for high-pressure systems and dirty water conditions.

KEY BENEFITS

- Optional Filter Sentry™ Mechanism scours the filter screen in dirty water conditions
- External/internal manual bleed allows for quick and easy activation at the valve
- Glass-filled nylon construction provides high pressure rating and reliability
- Double-beaded diaphragm seal design ensures leak-free performance
- Fabric-reinforced EPDM diaphragm and seat ensure greater performance in all water conditions
- Captive bonnet screws eliminate the possibility of lost parts during disassembly
- Triple-tool bonnet screws are compatible with standard or Phillips screwdrivers as well as a nut driver
- Encapsulated solenoid with captive plunger used on every Hunter valve provides hassle-free service
- Flow control maximises efficiency and prolongs the life of the system

USER-INSTALLED OPTIONS

- Accu Sync™ Pressure Regulator at the valve*
- DC-Latching Solenoid for battery-operated controllers (P/N 458200)
- Filter Sentry easily added to an installed valve

FACTORY-INSTALLED OPTIONS

- LS: Valve without solenoid
- DC: DC-Latching Solenoid for battery-operated controllers; **see page 261**
- FS: Filter Sentry
- FS-R: Reclaimed option with Filter Sentry, purple control knob, and purple chlorine-resistant diaphragm

OPERATING SPECIFICATIONS

- Flow:
 - ICV-101G: 0.03 to 9 m³/hr; 0.4 to 150 l/min
 - ICV-151G: 0.03 to 34 m³/hr; 0.4 to 568 l/min
 - ICV-201G: 0.03 to 45 m³/hr; 0.4 to 757 l/min
 - ICV-301: 0.03 to 68 m³/hr; 0.4 to 1,135 l/min
- Recommended pressure range: 1.5 to 15.0 bar; 150 to 1500 kPa
- Temperature rating: 66°C
- Warranty period: 5 years

SOLENOID SPECIFICATIONS

- 24 VAC solenoid
 - 350 mA inrush, 190 mA holding, 60 Hz
 - 370 mA inrush, 210 mA holding, 50 Hz

* Accu Sync product information on **page 98**



ICV-101G
Inlet diameter: 1" (25 mm)
Height: 14 cm
Length: 12 cm
Width: 10 cm



ICV-151G
Inlet diameter: 1½" (40 mm)
Height: 18 cm
Length: 17 cm
Width: 14 cm



ICV-201G
Inlet diameter: 2" (50 mm)
Height: 18 cm
Length: 17 cm
Width: 14 cm



ICV-301
Inlet diameter: 3" (80 mm)
Height: 27 cm
Length: 22 cm
Width: 19 cm



ICV-R
Inlet diameter: 1" (25 mm), 1½" (40 mm), 2" (50 mm), and 3" (80 mm)
Height: 18 cm
Length: 17 cm
Width: 14 cm

Double-Beaded Chlorine-Resistant Diaphragm

Filter Sentry Mechanism



ICV 1", 1½", 2" AND 3" - SPECIFICATION BUILDER: ORDER 1 + 2 + 3 + 4

1 Model	2 Standard Features	3 Feature Options	4 User-Installed Options
ICV-101-G-B = 1"(25 mm) BSP	Globe valve with flow control	(blank) = No option R = Filter Sentry purple reclaimed diaphragm and ID tag DC = DC-Latching Solenoid battery-operated controllers LS = Less solenoid	AS-ADJ = Accu Sync adjustable 458200 = DC-Latching Solenoid for battery-operated controllers 607105 = Reclaimed flow control handle (25, 40, 50 mm only) LIT-700 = Reclaimed ID tag
ICV-151-G-B = 1½" (40 mm) BSP			
ICV-201-G-B = 2" (50 mm) BSP			
ICV-301-B = 3" (80 mm) BSP	Globe / Angle valve with flow control		

Example:
ICV-201G-B-AS-ADJ = 2" (50 mm) BSP ICV globe valve with flow control, user-installed adjustable Accu Sync Pressure Regulator

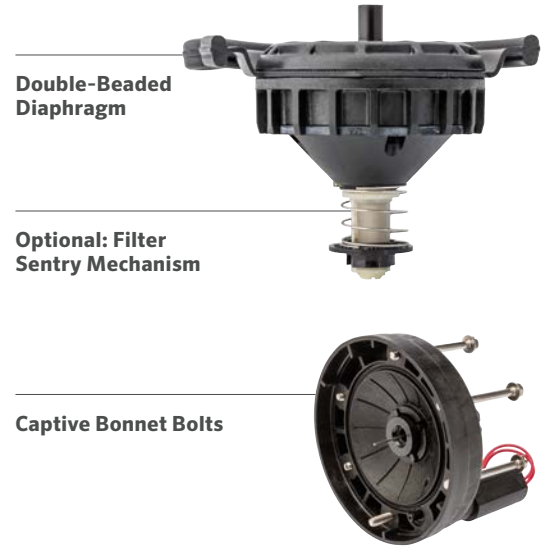

Flow m³/hr	1" (25 mm) Globe	1½" (40 mm) Globe	2" (50 mm) Globe	3" (80 mm) Globe	3" (80 mm) Angle
0.05	0.1				
0.1	0.1				
0.3	0.1				
1.0	0.2				
2.5	0.2				
3.5	0.2				
4.5	0.2	0.1			
7.0	0.4	0.1			
9.0	1.0	0.1	0.1		
11.0		0.2	0.1		
13.5		0.2	0.1		
17.0		0.3	0.1		
20.5		0.4	0.2		
23.0		0.5	0.3		
27.0		0.7	0.4		
30.5		0.9	0.5		
34.0		1.2	0.6	0.2	0.1
40.0			0.9	0.2	0.2
45.5			1.2	0.3	0.2
51.0				0.3	0.3
57.0				0.4	0.4
62.5				0.5	0.5
68.0				0.6	0.6

Flow l/min	1" (25 mm) Globe	1½" (40 mm) Globe	2" (50 mm) Globe	3" (80 mm) Globe	3" (80 mm) Angle
1	14				
2	14				
4	14				
20	17				
40	20				
60	20				
75	20	9.6			
115	62	10			
150	139	12	5.0		
190		15	7.0		
225		18	9.3		
280		26	14		
340		37	20		
380		46	26		
450		65	36		
510		84	47		
565		104	57	16	12
660			79	22	17
750			103	29	23
850				38	30
950				47	38
1,050				58	47
1,135				69	56



AC Solenoid
 (P/N 606800)
 Two red wires

DC-Latching Solenoid
 (P/N 458200)
 One black (common) wire and one red (station) wire

VALVES

Built of solid brass, this valve can power through the fiercest irrigation conditions.

KEY BENEFITS

- Factory-installed Filter Sentry™ Mechanism scours the filter screen in dirty water conditions
- External/internal manual bleed allows for quick and easy activation at the valve
- Heavy-duty brass construction provides high pressure rating and reliability
- Double-beaded diaphragm seal design ensures leak-free performance
- Fabric-reinforced EPDM diaphragm and seat ensure greater performance in all water conditions
- Triple-tool bonnet screws are compatible with standard or Phillips screwdrivers as well as a nut driver
- Encapsulated solenoid with captive plunger used on every Hunter valve provides hassle-free service
- Flow control maximises efficiency and prolongs the life of the system

USER-INSTALLED OPTIONS

- Accu Sync™ Pressure Regulator at the valve*
- DC-Latching Solenoid for battery-operated controllers (P/N 458200)

FACTORY-INSTALLED OPTIONS

- DC: DC-Latching Solenoid for battery-operated controllers; see page 261

OPERATING SPECIFICATIONS

- Flow rate:
 - IBV-101G-FS: 0.03 to 9 m³/hr; 0.4 to 150 l/min
 - IBV-151G-FS: 0.03 to 34 m³/hr; 0.4 to 568 l/min
 - IBV-201G-FS: 0.03 to 45 m³/hr; 0.4 to 757 l/min
 - IBV-301G-FS: 0.03 to 68 m³/hr; 0.4 to 1,135 l/min
- Recommended pressure range: 1.5 to 15 bar; 150 to 1500 kPa
- Temperature rating: 66°C
- Warranty period: 5 years

SOLENOID SPECIFICATIONS

- 24 VAC solenoid
 - 350 mA inrush, 190 mA holding, 60 Hz
 - 370 mA inrush, 210 mA holding, 50 Hz

* Accu Sync product information on page 98



IBV-101G-FS
Inlet diameter: 1" (25 mm)
Height: 14 cm
Length: 12 cm
Width: 8 cm



IBV-151G-FS
Inlet diameter: 1½" (40 mm)
Height: 17 cm
Length: 15 cm
Width: 15 cm



IBV-201G-FS
Inlet diameter: 2" (50 mm)
Height: 18 cm
Length: 15 cm
Width: 15 cm



IBV-301G-FS
Inlet diameter: 3" (80 mm)
Height: 23 cm
Length: 22 cm
Width: 18 cm

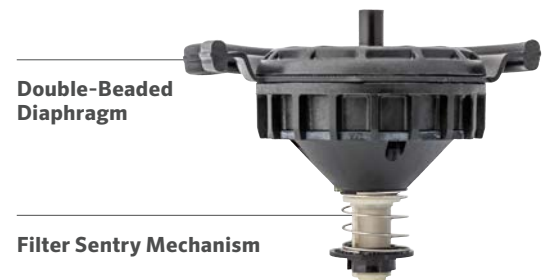

Double-Beaded Diaphragm

Filter Sentry Mechanism

IBV 1", 1½", 2" & 3" - SPECIFICATION BUILDER: ORDER 1 + 2 + 3 + 4

1	Model	2 Standard Features	3 Feature Options	4 User-Installed Options
	IBV-101G-B-FS = 1" (25 mm) BSP	Brass Globe valve with flow control, Filter Sentry diaphragm	(blank) = No Option R = Filter Sentry purple reclaimed diaphragm and ID tag DC = DC-Latching Solenoid for battery-operated controllers LS = Less solenoid	AS-ADJ = Accu Sync adjustable Pressure Regulator 458200 = DC-Latching Solenoid for battery-operated controllers 607105 = Reclaimed flow control handle LIT-700 = Reclaimed ID tag
	IBV-151G-B-FS = 1½" (40 mm) BSP			
	IBV-201G-B-FS = 2" (50 mm) BSP			
	IBV-301G-B-FS = 3" (80 mm) BSP			

Double-Beaded Chlorine-Resistant Diaphragm

Filter Sentry Mechanism



VALVES

Example:

IBV-201G-B-FS-AS-ADJ = 2" (50 mm) BSP IBV brass globe valve with flow control, Filter Sentry diaphragm, user-installed adjustable Accu Sync Pressure Regulator

IBV PRESSURE LOSS (AT OPTIMAL FLOWS) IN BAR				
Flow m ³ /hr	1" (25 mm) Globe	1½" (40 mm) Globe	2" (50 mm) Globe	3" (80 mm) Globe
0.05	0.1			
0.1	0.1			
0.3	0.1			
1.0	0.2			
2.5	0.2			
3.5	0.2			
4.5	0.2	0.1		
7.0	0.4	0.1		
9.0	1.0	0.1	0.1	
11.0		0.2	0.1	
13.5		0.2	0.1	
17.0		0.3	0.2	
20.5		0.4	0.2	
23.0		0.5	0.3	
27.0		0.7	0.4	
30.5		0.9	0.5	
34.0			0.6	0.2
40.0				0.2
45.5				0.3
51.0				0.3
57.0				0.4
62.5				0.5
68.0				0.6

IBV PRESSURE LOSS (AT OPTIMAL FLOWS) IN kPa				
Flow l/min	1" (25 mm) Globe	1½" (40 mm) Globe	2" (50 mm) Globe	3" (80 mm) Globe
0.1	14			
0.5	14			
4	14			
20	17			
40	20			
60	20			
75	20	9.6		
115	62	10		
150	139	12	5	
190		15	7	
225		18	9.3	
280		26	14	
340		37	20	
380		46	26	
450		65	36	
510		84	47	
565			57	16
660				22
750				29
850				38
950				47
1,050				58
1,135				69

QUICK COUPLERS

The sturdy red brass and stainless steel construction of Quick Couplers strengthens any project.

FEATURES

- 100% interchangeable with major brands
- Red brass and stainless steel construction
- Heavy-duty thermoplastic locking and non-locking covers
- Optional winged stabilisation and Acme key connection
- Stainless steel lug on 1" (25 mm) and 1¼" (32 mm) keys
- Spring-loaded covers with stainless steel springs for positive closing and protection of valve's sealing components
- Warranty period: 5 years



Quick Couplers

HQ QUICK COUPLER - SPECIFICATION BUILDER: ORDER 1 + 2 + 3

1 Model	2 Cover Options	3 Additional Options
HQ-3 = ¾" inlet, 1-piece body, 2 slots HQ-5 = 1" (25 mm) inlet, 1-piece body, 1 slot HQ-33D = ¾" inlet, 2-piece body, 2 slots HQ-44 = 1" (25 mm) inlet, 2-piece body, 1 slot or Acme	RC = Yellow rubber cover LRC = Yellow locking rubber cover <i>(Not available for HQ-3 body)</i>	(blank) = No option AW = Acme key with anti-rotation wings <i>(Only available for HQ-44 body)</i> BSP = BSP threads <i>(Only available for HQ-5 body)</i> R = Purple locking cover (reclaimed water ID; only available for LRC models)

Examples:

- HQ-3-RC = HQ-3 valve with rubber cover
- HQ-44-LRC = HQ-44 valve with locking rubber cover
- HQ-44-LRC-R = HQ-44 valve with locking rubber cover and purple locking cover
- HQ-44-LRC-AW-R = HQ valve, with locking rubber cover, Acme key socket, anti-rotation wings and purple locking cover
- HQ-5-LRC-BSP = HQ-5 valve with locking rubber cover and BSP threads



Reclaimed Water Option

All locking models have an optional purple cover for sites using reclaimed water.

HK KEYS

Key Model	Compatible Valve	Compatible Swivel
HK-33 = ¾" valve, ¾" key inlet	HQ-3, HQ-33	HS-0
HK-44 = 1" (25 mm) valve, 1" (25 mm) key inlet	HQ-44	HS-1, HS-2, HS-1-B, HS-2-B
HK-44A = 1" (25 mm) valve, Acme key inlet	HQ-44-AW	HS-1, HS-2, HS-1-B, HS-2-B
HK-55 = 1" (25 mm) valve, 1¼" (32 mm) key inlet	HQ-5	HS-1, HS-2, HS-1-B, HS-2-B

HS HOSE SWIVELS

Hose Swivel	Compatible Key
HS-0 = ¾" inlet, ¾" hose outlet	HK-33
HS-1 = 1" (25 mm) inlet, ¾" hose outlet	HK-44, HK-44A, HK-55
HS-2 = 1" (25 mm) inlet, 1" (25 mm) hose outlet	HK-44, HK-44A, HK-55
HS-1-B = 1" (25 mm) inlet, ¾" (20 mm) BSP outlet	HK-44, HK-44A, HK-55
HS-2-B = 1" (25 mm) inlet, 1" (25 mm) BSP outlet	HK-44, HK-44A, HK-55

QUICK COUPLER, KEY, AND HOSE SWIVEL CHARTS

Model	Inlet Threads	Slots	Body	Colour*	Locking	Key	Swivels
HQ-3-RC	¾"	2	1-piece	Yellow	No	HK-33	HS-0
HQ-33-DRC	¾"	2	2-piece	Yellow	No	HK-33	HS-0
HQ-33-DLRC	¾"	2	2-piece	Yellow	Yes	HK-33	HS-0
HQ-44-RC	1" (25 mm) NPT	1	2-piece	Yellow	No	HK-44	HS-1 or HS-2
HQ-44-LRC	1" (25 mm) NPT	1	2-piece	Yellow	Yes	HK-44	HS-1 or HS-2
HQ-44-RC-AW	1" (25 mm) NPT	Acme	2-piece wing**	Yellow	No	HK-44A	HS-1 or HS-2
HQ-44-LRC-AW	1" (25 mm) NPT	Acme	2-piece wing**	Yellow	Yes	HK-44A	HS-1 or HS-2
HQ-5-RC	1" (25 mm) NPT	1	1-piece	Yellow	No	HK-55	HS-1 or HS-2
HQ-5-LRC	1" (25 mm) NPT	1	1-piece	Yellow	Yes	HK-55	HS-1 or HS-2
HQ-5-RC-BSP	1" (25 mm) BSP	1	1-piece	Yellow	Yes	HK-55	HS-1 or HS-2
HQ-5-LRC-BSP	1" (25 mm) BSP	1	1-piece	Yellow	Yes	HK-55	HS-1 or HS-2

Notes:

* All locking cover models are available with purple covers for reclaimed water applications

** Anti-rotation stabilisation wings

HQ PRESSURE LOSS IN BAR					HQ PRESSURE LOSS IN kPa				
Flow m ³ /hr	HQ-3	HQ-33	HQ-44	HQ-5	Flow l/min	HQ-3	HQ-33	HQ-44	HQ-5
1	0.06	0.07			18.9	5.5	6.9		
2.3	1.12	0.14			37.9	12.4	13.8		
3.4	0.28	0.30	0.15		56.8	28.3	29.6	15.2	
4.5	0.50	0.52	0.30	0.07	75.7	49.6	52.4	30.3	6.9
6.8			0.79	0.21	113.6			79.3	20.7
9.1				0.43	151.4				43.4
11.4				0.63	189.3				63.4
13.6				0.90	227.1				89.6
15.9				1.37	265.0				136.5

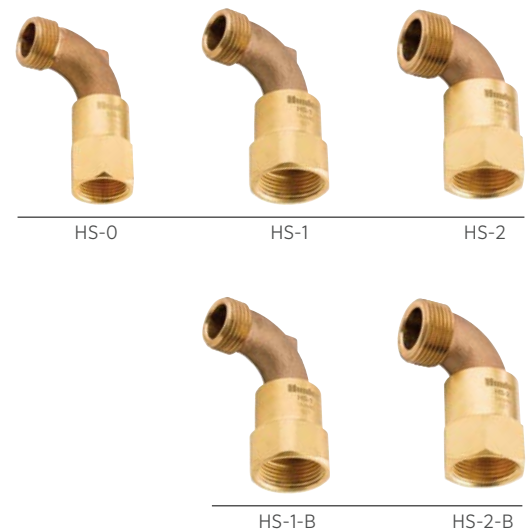

ACCU SYNC™ PRESSURE REGULATORS

Gain unparalleled pressure regulation for any Hunter valve.

OPERATING SPECIFICATIONS

- Regulation from 1.4 to 7.0 bar; 140 to 700 kPa
- Static pressure: 10 bar; 1,000 kPa
- Required dynamic pressure differential: 1.0 bar; 100 kPa
- Works with AC and DC-Latching Solenoids
- Works with any Hunter valve
- Warranty period: 2 years

ACCU SYNC VALVE RECOMMENDED FLOW RANGE

Valve	Flow	
	m ³ /hr	l/min
PGV-100/101	1.2-6.8	19-114
PGV-151	4.5-28	75-454
PGV-201	9.0-34	150-750
ICV-101	1.2-9.0	19-150
ICV-151	4.5-31	75-510
ICV-201	9.0-34	150-560
ICV-301	34-68	565-1135
IBV-101	1.2-9.0	19-150
IBV-151	4.5-31	75-510
IBV-201	9.0-46	150-560
IBV-301	34-68	565-1135

ACCU SYNC APPLICATIONS

- **Adjustable 1.4 to 7.0 bar** For full customisation, the adjustable Accu Sync can regulate pressure from 1.4 to 7.0 bar; 140 to 700 kPa
- **Fixed 2.1 bar** Ideal for spray systems, pressure-regulated to 2.1 bar; 210 kPa
- **Fixed 2.8 bar** Ideal for MP Rotator Nozzles and large in-line drip systems, pressure-regulated to 2.8 bar; 280 kPa

ACCU SYNC PRESSURE REGULATORS- SPECIFICATION BUILDER: ORDER 1 + 2

1 Model	2 Inlet/Outlet
ACCU SYNC	ADJ = Adjustable Pressure Regulator (1.4 to 7.0 bar) 30 = Fixed Pressure Regulator (2.1 bar) 40 = Fixed Pressure Regulator (2.8 bar)

Example:
 ICV-201G-B-AS-ADJ = 2" (50 mm) BSP ICV globe valve with flow control, user-installed adjustable Accu Sync Pressure Regulator

ADJUSTABLE



AS-ADJ
Height with solenoid: 8 cm

ADAPTER



SOLENOID ADAPTER

FIXED



AS-30
Height with solenoid: 8 cm



AS-40
Height with solenoid: 8 cm



Installation

Accu Sync shown installed on ICV and PGV Valves.



HUNTER VALVES

BUILT TO THRIVE UNDER PRESSURE

From residential to commercial applications, high pressure to low pressure, and clean water to dirty water, Hunter valves keep your system running flawlessly day in and day out.

ULTIMATE RELIABILITY

- Fewer parts means greater longevity and simple operation
- AC and DC models for flexibility
- Residential models handle up to 10 bar; 1000 kPa
- Commercial models handle up to 15 bar; 1500 kPa

SIMPLE PRESSURE REGULATION

- Regulating at the valve greatly enhances efficiency
- Accu Sync™ Pressure Regulators provide simple regulation from 1.4 to 7.0 bar; 140 to 700 kPa



CONTROLLERS



CONTROLLERS

CONTROLLER

SELECTION GUIDE

Platform

AC-Powered Controllers

STANDARD

Details on [page 104](#)

Button and dial-based controllers are standalone systems that offer water-saving features and convenient remote control operation for faster maintenance.

Eco Logic

Stations: 4, 6
page 106



X-Core™

Stations: 2, 4, 6, 8
page 107



X2™

Stations: 4, 6, 8, 14
page 108



Pro-C™

Stations: 4-32, 6, 12
page 109



HYDRAWISE®

Details on [page 110](#)

The Wi-Fi controller solution designed for contractors. Hydrowse is simple to set up, easy to use, and packed with helpful features, to help you remotely manage your customers' irrigation systems. Built-in system monitoring and a suite of powerful tools make saving water and managing customers or multiple sites easy.

HC

Stations: 6, 12
page 114



WAND for X2

Stations: 4, 6, 8, 14
page 115



Pro-HC

Stations: 6, 12, 24
page 116



HPC

Stations: 4-32
page 117



HCC

Stations: 8-54
page 118



CENTRALUS™

Details on [page 120](#)

Add cloud-based control and monitoring for ICC2 and ACC2 Controllers with the mobile-friendly Centralus Irrigation Management Platform.

ICC2

Stations: 8-54
page 123



ACC2

Stations: 12-54 conventional, 1-225 with two-wire
page 124



Use this guide to quickly compare Hunter controller power needs, station counts, and software platforms to ensure you choose the best controller for every installation.

Platform

Battery-Operated Controllers

INDEPENDENT

Details on [page 126](#)

Battery-operated controllers allow automatic irrigation for power-restricted valve locations and areas where hardscape blocks the ability to run wire affordably.

NODE
Stations: 1, 2, 4, 6
page 129



XC Hybrid
Stations: 6, 12
page 131



BLUETOOTH®

Details on [page 126](#)

Bluetooth enabled, battery-operated controllers have all the benefits of independent battery controllers with convenient, on-site wireless control from a smartphone.

BTT
Zones: 1, 2
page 128



NODE-BT
Stations: 1, 2, 4
page 130



With two-wire, you can easily expand the system as needed after installation.

STANDARD CONTROLLERS

STANDARD CONTROLLERS





Standard controllers are self-contained irrigation systems designed for simple installation and programming. They offer locally measured weather monitoring capabilities for automatic schedule adjustments, the option of modular station flexibility, and convenient remote control operation for faster maintenance.

STANDARD CONTROLLER COMPARISON CHART

CONTROLLER MODELS	MAXIMUM STATIONS	SENSOR INPUTS	TWO-WIRE	REMOTE CONTROL	WEB ACCESS
ECO LOGIC	6	1	N/A	N/A	N/A
X-CORE	8	1	N/A	ROAM, ROAM XL	N/A
X2	14	1	N/A	ROAM, ROAM XL, Hydrawise App	Hydrawise, Wi-Fi
PRO-C	32	1	EZDS	ROAM, ROAM XL	N/A

ECO LOGIC

The reliable Eco Logic Controller is the first choice for small residential areas and has the option for water-saving accessories.

KEY BENEFITS

- Number of stations:
 - 4 or 6 (fixed models)
- 2 programs with 4 start times each, and up to 4-hour run times
- QuickCheck™ Technology provides simple diagnostics of faulty field wiring
- Suspend irrigation up to 7 days during the off-season
- Short-circuit protection detects wiring faults and skips the station without system damage
- Seasonal adjustment for quicker schedule adjustments without changing run times

OPERATING SPECIFICATIONS

- Transformer input: 230 VAC
- Transformer output (24 VAC): 0.625 A
- Station output (24 VAC): 0.56 A
- P/MV output (24 VAC): 0.28 A
- Sensor inputs: 1
- Approvals: UL, cUL, FCC, CE, RCM, ISED
- Warranty period: 2 years

ECO LOGIC

Model	Description
ELC-401i-E	4-station indoor controller, 230 VAC wall adapter
ELC-601i-E	6-station indoor controller, 230 VAC wall adapter



Plastic Indoor

Height: 12.6 cm
Width: 12.6 cm
Length: 3.2 cm

Compatible with:



**Soil-Clik
Sensor**
Page 150



**Wind-Clik
Sensor**
Page 151

ECO LOGIC



X-CORE™

This simple irrigation controller offers optional on-site smart ET watering adjustments and handheld remote operation.

KEY BENEFITS

- Number of stations:
 - 2, 4, 6, or 8 (fixed models)
- Add a Solar Sync™ Sensor to save water based on local weather conditions
- Built-in key lock on outdoor models protects against vandalism
- 3 flexible programs with 4 start times each and up to 4-hour run times
- QuickCheck™ Technology provides simple diagnostics of faulty field wiring
- Hide Programs setting shows 1 program and 1 start time for simplification
- Suspend irrigation up to 99 days during the off-season
- Short-circuit protection detects wiring faults and skips the station without system damage
- Easy Retrieve™ Memory backs up the full irrigation schedule
- Delay Between Stations for slow-closing valves or pump recharge
- Cycle and Soak prevents water waste and runoff in areas with elevation changes or tight soils
- Seasonal adjustment for quicker schedule adjustments without changing run times

OPERATING SPECIFICATIONS

- Transformer input: 120 VAC or 230 VAC
- Transformer output (24 VAC): 1 A
- Station output (24 VAC): 0.56 A
- P/MV output (24 VAC): 0.28 A
- Sensor inputs: 1
- Approvals: Plastic IP54 (outdoor), UL, cUL, FCC, CE, RCM, ISED
- Warranty period: 2 years



Plastic Indoor

Height: 16.5 cm
Width: 14.6 cm
Depth: 5 cm



Plastic Outdoor

Height: 22 cm
Width: 17.8 cm
Depth: 9.5 cm

X-CORE - SPECIFICATION BUILDER: ORDER 1 + 2 + 3 + 4

1	Model	2	Transformer	3	Indoor/Outdoor	4	Plug
	XC-2 = 2-station (indoor only)		00 = 120 VAC		(blank) = Outdoor model		(blank) = American plug
	XC-4 = 4-station		01 = 230 VAC		i = Indoor model		E = European connections, no plug
	XC-6 = 6-station						A = Australian plug
	XC-8 = 8-station						

Examples:

XC-801i-E = 8-station controller, 230 VAC European wall adapter, indoor

XC-801-A = 8-station controller, 230 VAC internal transformer, outdoor with Australian plug

Compatible with:



**Solar Sync
Sensor**
Page 153



ROAM Remote
Page 140
ROAM XL Remote
Page 141

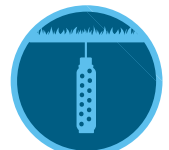

**Soil-Clik
Sensor**
Page 150



Smart WaterMark

Recognised as a responsible water-saving tool when used with a Solar Sync Sensor

X2™

This online-capable controller offers rapid schedule programming and advanced water-saving features.

KEY BENEFITS

- Number of stations:
 - 4, 6, 8, or 14 (fixed models)
- Wi-Fi capable controller automatically managed by Hydrawise® Software
- Backlit display provides optimal visibility in any light
- 3 flexible programs with 4 start times each and up to 6-hour run times
- QuickCheck™ Technology provides simple diagnostics of faulty field wiring
- Hide Programs option shows 1 program and 1 start time for simplification
- Suspend irrigation up to 99 days during the off-season
- Short-circuit protection detects wiring faults and skips the station without system damage
- Easy Retrieve™ Memory backups the full irrigation schedule
- Delay Between Stations for slow-closing valves or pump recharge
- Cycle and Soak prevents water waste and runoff in areas with elevation changes or tight soils
- Seasonal adjustment for quicker schedule adjustments without changing run times

WI-FI MODULE BENEFITS

- Provides online irrigation management with controller status and faulty wiring alerts
- Standard ABC programming allows for 3 independent programs with 6 start times per program and 24-hour maximum run times
- Predictive Watering™ provides precise weather adjustments for maximum water savings
- Compatibility with Amazon Alexa™, Control4®, and HomeSeer
- See complete WAND Wi-Fi Module benefits and specifications on [page 115](#)

OPERATING SPECIFICATIONS

- Transformer input: 120 VAC or 230 VAC
- Transformer output (24 VAC): 1 A
- Station output (24 VAC): 0.56 A
- P/MV output (24 VAC): 0.28 A
- Sensor inputs: 1
- Approvals (controller): Plastic IP55 (outdoor), UL, cUL, FCC, CE, RCM, ISED
- Approvals (module): Wi-Fi b/g/n, Bluetooth® 5.0, UL, cUL, FCC, CE, RCM, ISED
- Warranty period: 2 years



X2
Height: 23 cm
Width: 19 cm
Depth: 10 cm



WAND Bluetooth and Wi-Fi Module
Height: 2 cm
Width: 5 cm
Depth: 5 cm

Compatible with:



Hydrawise Software
Page 112



ROAM Remote
Page 140
ROAM XL Remote
Page 141



Rain-Click Sensor
Page 148



Smart WaterMark

Recognised as a responsible water-saving tool when used with the WAND Module

The Bluetooth® word mark and logos are registered trademarks owned by Bluetooth SIG Inc. and any use of such marks by Hunter Industries is under licence. Amazon Alexa is a trademark of Amazon.com Inc. or its affiliates. Control4 is a registered trademark of Control4 Corporation in the United States and/or other countries. HomeSeer is a trademark of HomeSeer Technologies LLC.

X2 - SPECIFICATION BUILDER: ORDER 1 + 2 + 3

1 Model	2 Transformer	3 Plug
X2-4 = 4-station	00 = 120 VAC	(blank) = American plug
X2-6 = 6-station	01 = 230 VAC	E = European connections, no plug
X2-8 = 8-station		A = Australian plug
X2-14 = 14-station		

Examples:

- X2-1401-E = 14-station controller, 230 VAC internal transformer with no plug
- X2-1401-A = 14-station controller, 230 VAC internal transformer with Australian plug

WAND MODULE

Model	Description
WAND	Bluetooth and Wi-Fi Module for Hydrawise Irrigation Management Platform

PRO-C™

Simple programming and flexible station expansion make Pro-C the professional's choice for residential and light commercial systems.

KEY BENEFITS

- Number of stations:
 - Modular Pro-C
 - Conventional wiring from 4 to 23 stations
 - Hybrid EZ Decoder option up to 32 total stations (28 stations max. if two-wire only)
 - Fixed PCC with 6- and 12-station options
- 3 independent irrigation programs (4 start times each) allow for customised scheduling
- 1 sensor input available for use with Solar Sync™ or any Klik sensors
- 1 P/MV output for pump start relay and master valve activation
- Add a Solar Sync™ Sensor to save water based on local weather conditions
- Easy Retrieve™ Memory allows for manual backup and retrieval of preferred settings and programming
- QuickCheck™ Technology provides simple diagnostics of faulty field wiring

OPERATING SPECIFICATIONS

- Transformer input: 120 VAC or 230 VAC
- Transformer output (24 VAC): 1 A
- Station output (24 VAC): 0.56 A
- P/MV output (24 VAC): 0.28 A
- Approvals: IP44 (outdoor), UL, cUL, FCC, CE, RCM, ISED
- Warranty period: 2 years



Plastic Indoor
Height: 22.9 cm
Width: 25.4 cm
Depth: 11.4 cm



Plastic Outdoor
Height: 22.9 cm
Width: 25.4 cm
Depth: 11.4 cm

PRO-C - SPECIFICATION BUILDER: ORDER 1 + 2 + 3 + 4

1	Model	2	Transformer	3	Indoor/Outdoor	4	Options
	PC-4 = 4-station base module controller		00 = 120 VAC		(blank) = Outdoor model (internal transformer)		(blank) = No option
	PCC-6 = 6-station		01 = 230 VAC		i = Indoor model (plug-in transformer)		E = 230 VAC with European connections, no plug
	PCC-12 = 12-station						A = 230 VAC with Australian connections (outdoor models have internal transformer with plug)

Examples:

PC-400 = Modular 4-station outdoor base unit, internal 120 VAC transformer, and plastic cabinet

PCC-601i-E = Fixed 6-station indoor controller, plug-in 230 VAC transformer with European connections, and plastic cabinet

PCC-1200 = Fixed 12-station outdoor controller, internal 120 VAC transformer, and plastic cabinet

PC-SERIES STATION EXPANSION

Modules	Description
PCM-300	3-station plug-in module
PCM-900	9-station plug-in module
PCM-1600	16-station plug-in module
PC-DM	EZ Decoder output module
PCM-1600-KIT	Upgrade kit for 16-station plug-in module
PC-DM-KIT	Upgrade kit for EZ Decoder output module

Compatible with:



Solar Sync Sensor
Page 153



ROAM Remote
Page 140
ROAM XL Remote
Page 141

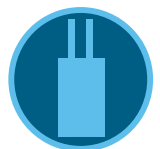

EZ Decoder System
Page 136



Smart WaterMark

Recognised as a responsible water-saving tool when used with a Solar Sync Sensor

HYDRAWISE[®] CONTROLLERS



PRO-HC Wi-Fi

Hunter[®]



A healthy, beautiful garden needs just the right amount of water to thrive. The Hydrawise Irrigation Management Platform automatically adjusts watering based on local weather data. Choose from a complete lineup of Hydrawise enabled controllers to maximise water and money savings in any setting.

HYDRAWISE CONTROLLER COMPARISON CHART

CONTROLLER MODELS	MAXIMUM STATIONS	SENSOR INPUTS	TWO-WIRE	REMOTE CONTROL	WEB ACCESS	FLOW
HC	12	2	N/A	Hydrawise App	Hydrawise: Wi-Fi	HC Flow Meter (wired or wireless)
WAND for X2	14	1	N/A	ROAM, ROAM XL, Hydrawise App	Hydrawise: Wi-Fi	N/A
PRO-HC	24	2	N/A	Hydrawise App	Hydrawise: Wi-Fi	HC Flow Meter (wired or wireless)
HPC	32	1	EZDS	ROAM, ROAM XL, Hydrawise App	Hydrawise: Wi-Fi	HC Flow Meter (wired or wireless)
HCC	54	2	EZDS	ROAM, ROAM XL, Hydrawise App	Hydrawise: Wi-Fi	HC Flow Meter (wired or wireless)

HYDRAWISE® SOFTWARE

As the industry's best Wi-Fi control solution, the Hydrowise Irrigation Management Platform allows for professional multi-site management and provides a range of helpful water-saving features for end users.



Save Water

PREDICTIVE WATERING™

Predictive Watering Technology uses past, current, and forecast weather data sourced from the internet to automatically adjust to local, real-time conditions and provide homeowners and end users with tremendous water savings.

VIRTUAL SOLAR SYNC™

Virtual Solar Sync uses daily ET measurements from your selected weather stations to supplement the Predictive Watering adjustments on your controller, working to save even more water.



Protect the Landscape

SYSTEM MONITORING

Flow rate and valve monitoring alert you in the event of a problem, so you can quickly prevent landscape degradation before significant damage occurs.

WEATHER MONITORING

Web-based climate monitoring automatically adjusts irrigation systems to local weather conditions, ensuring plants remain healthy — rain or shine.



Save Time and Labour

REMOTE MANAGEMENT

Make changes to a program and know the status of the controller and the irrigation plan without a site visit.

STORE CUSTOMER PLANS AND DESIGNS

Attach irrigation system layouts to your customers' controllers for quick reference in the field. Never forget the location of the pipes or valve box again.

ON-SITE REMOTE

Turn your smartphone into a remote control to make changes and check the irrigation system without visiting the controller.

All trademarks are property of their respective owners.



Build a Stronger Business

BUILD A STRONGER BUSINESS

Add services, grow revenue, increase customer satisfaction, and rest assured that Hydrowise has your back as you expand your business.

BUSINESS BRANDING

Gain instant recognition from your customers by including your business logo and details in your Hydrowise account.

MULTI-SITE MANAGER

Manage customers or multiple sites with our unique business tools.

- Summary of all controllers
- Map view of controllers
- List view of customers/sites
- Search for customers and controllers
- View all controller events and logs
- View all controller alerts
- Branded automatic email reporting to customers
- Global control settings
 - Alerts
 - Watering Schedules
 - Start Times
 - Watering Triggers
- Quick select controllers
- Generate job sheets
- Manage subcontractors or regions

BUSINESS ACCOUNT

Manage staff access with different levels of permission. Remove or add staff easily and quickly. Add and store files, irrigation plans, layouts, or other documents for access by your staff.

MESSAGING

Receive messages from and send messages to customers and staff through the Hydrowise App.



Manage from Anywhere

GLOBAL APP AND WEB ACCESS

Sit back and relax. With Hydrowise, everything you need is in the palm of your hand. Remote access allows you to view, manage, and monitor irrigation controllers from your smartphone, tablet, or computer at your convenience.

SMART-HOME COMPATIBILITY

Hydrowise integrates seamlessly with Amazon Alexa™, Control4®, and HomeSeer.

What's New with Hydrawise

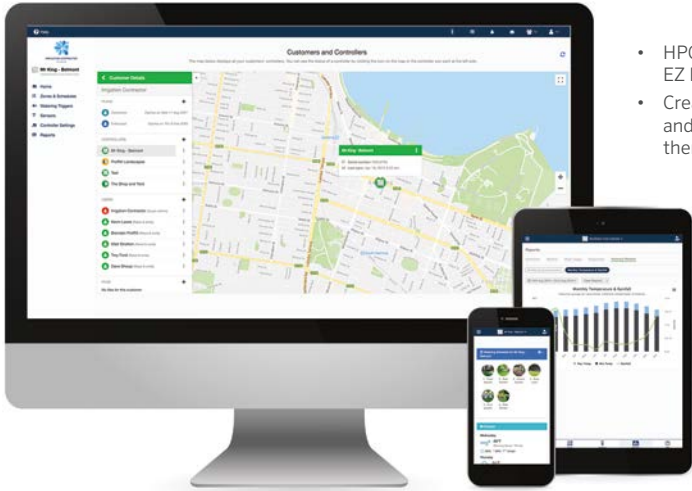

- HPC Controller now compatible with the EZ Decoder System up to 32 stations
- Create custom reports for water savings and forecasts and automatically email them to your customers
- WAND Module for X2 Controllers provides super-fast Bluetooth remote, Wi-Fi setup, and a convenient copy-paste function
- Nine new updates to the Contractor Portal
- Controller touchscreen enhancements



Smart WaterMark
Recognised as a responsible water-saving tool

 Access to Hydrawise Software is free for all users worldwide.
To learn more, visit hydrawise.com.



HC Controller
6- and 12-station count



X2 Controller with WAND Module
4-, 6-, 8-, and 14-station count



Pro-HC Controller
6-, 12-, and 24-station count



HPC Controller
4- to 32-station count, EZDS two-wire option



HCC Controller
8- to 54-station count, EZDS two-wire option



HC Flow Meter
Add an optional flow meter to receive flow alerts and monitor water consumption
Not available for X2

HC

The cost-effective solution for residential projects, the HC Controller provides smart water savings and remote irrigation management capabilities.

KEY BENEFITS

- Number of stations:
 - 6 or 12 (fixed models)
- Standard programming option allows for 6 independent irrigation programs and 6 start times per program
- Advanced programming option provides station-based programming with up to 6 total start times available
- 2 sensor inputs available for use with any Clik sensors and HC Flow Meter
- Station outputs can also be used to activate a pump start relay or master valve
- Wi-Fi enabled for quick connection to Hydrawise Software
- 7 cm full-colour touchscreen display for simple programming at the control panel
- Built-in milliamp sensor for wire fault detection and alerts (12-zone models)

OPERATING SPECIFICATIONS

- Transformer input: 120 VAC or 230 VAC
- Transformer output (24 VAC): 1 A
- Station output (24 VAC): 0.56 A
- P/MV output (24 VAC): 0.28 A
- 2.4 GHz (only) Wi-Fi router compatible, 802.11 b/g/n 20 MHz
- Supported security protocols: WPA/WPA2 Personal (only) TLS, SSL
- Approvals: UL, cUL, FCC, CE, RCM, ISED
- Warranty period: 2 years

USER-INSTALLED OPTIONS

- Wireless HC Flow Meter option permits wireless flow monitoring for Hydrawise enabled systems; **see page 155**

Try Hydrawise Software today, hardware-free at hydrawise.com



HC
(plastic indoor)
Height: 15.2 cm
Width: 17.8 cm
Depth: 3.3 cm

Compatible with:

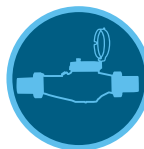

HC Flow Meter
Page 155



Soil-Clik Sensor
Page 150



Rain-Clik Sensor
Page 148

HC	
Model	Description
HC-600i	Fixed 6-station, plastic indoor wall mount, 120 VAC wall adapter
HC-601i-E	Fixed 6-station, plastic indoor wall mount, 230 VAC European wall adapter
HC-601i-A	Fixed 6-station, plastic indoor wall mount, 230 VAC Australian wall adapter
HC-1200i	Fixed 12-station, plastic indoor wall mount, 120 VAC wall adapter
HC-1201i-E	Fixed 12-station, plastic indoor wall mount, 230 VAC European wall adapter
HC-1201i-A	Fixed 12-station, plastic indoor wall mount, 230 VAC Australian wall adapter



Smart WaterMark
Recognised as a responsible water-saving tool

WAND FOR X2™

This Wi-Fi upgrade option equips X2 Controllers with remote management capabilities from anywhere with an internet connection.

Try Hydrawise Software today, hardware-free at hydrawise.com

KEY BENEFITS

- This simple, plug-in device enables Hydrawise irrigation management capabilities for any X2 Controller to provide maximum water savings
- Provides controller status updates and faulty wiring alerts to signify the need for maintenance before costly landscape damage occurs
- Standard programming allows for 3 independent programs with 6 start times per program and 24-hour maximum run times
- Transfer X2 programming to Hydrawise for faster software setup
- Rapid Programming™ allows an existing Hydrawise schedule to be copied to any standalone X2 Controller for full schedule set up in seconds without touching the dial or buttons
- Use your smartphone as a manual remote when Wi-Fi is unavailable or the controller is hard to access
- Compatible with Amazon Alexa™, Control4®, and HomeSeer
- See complete X2 Controller key benefits and specifications on **page 108**

OPERATING SPECIFICATIONS

- Flexible setup options: Bluetooth® Wi-Fi tether, Wi-Fi direct, or WPS push-button connection
- Bluetooth 5.0
- 2.4 GHz (only) Wi-Fi router compatible, 802.11 b/g/n 20 MHz
- Supported security protocols: WPA/WPA2 Personal (only) TLS, SSL
- Approvals: UL, cUL, FCC, CE, RCM, ISED
- Warranty period: 2 years



WAND Bluetooth and Wi-Fi Module
Height: 2 cm
Width: 5 cm
Depth: 5 cm



WAND Module installed in X2 Controller

WAND MODULE	
Model	Description
WAND	Bluetooth and Wi-Fi Module for Hydrawise Irrigation Management Platform
X2	See page 108 for model chart

WAND INSTALLATION



Compatible with:



X2 Controller
Page 108



ROAM Remote
Page 140
ROAM XL Remote
Page 141



Rain-Clik Sensor
Page 148



Smart WaterMark

Recognised as a responsible water-saving tool

The Bluetooth® word mark and logos are registered trademarks owned by Bluetooth SIG Inc. and any use of such marks by Hunter Industries is under licence. Amazon Alexa is a trademark of Amazon.com Inc. or its affiliates. Control4 is a registered trademark of Control4 Corporation in the United States and/or other countries. HomeSeer is a trademark of HomeSeer Technologies LLC.

PRO-HC

Use this rugged, professional-grade Wi-Fi controller for residential and light commercial applications.

KEY BENEFITS

- Number of stations:
 - 6, 12, or 24 (fixed models)
- Standard programming option allows for 6 independent irrigation programs and 6 start times per program
- Advanced programming option provides station-based programming with up to 6 total start times available
- 2 sensor inputs available for use with any Klik sensor and HC Flow Meter
- 1 P/MV output for pump start relay and master valve activation
- Wi-Fi enabled for quick connection to Hydrowise software
- 7 cm full-colour touchscreen display for simple programming at the control panel
- Built-in milliamp sensor for wire fault detection and alerts

OPERATING SPECIFICATIONS

- Transformer input: 120 VAC or 230 VAC
- Transformer output (24 VAC): 1 A
- Station output (24 VAC): 0.56 A
- P/MV output (24 VAC): 0.28 A
- 2.4 GHz (only) Wi-Fi router compatible, 802.11 b/g/n 20 MHz
- Supported security protocols: WPA/WPA2 Personal (only) TLS, SSL
- Approvals: IP44 (outdoor), UL, cUL, FCC, CE, RCM, ISED
- Warranty period: 2 years

USER-INSTALLED OPTIONS

- Wireless HC Flow Meter option permits wireless flow monitoring for Hydrowise enabled systems; [see page 155](#)

Try Hydrowise Software today, hardware-free at hydrowise.com



Pro-HC
(plastic indoor)
Height: 21 cm
Width: 24 cm
Depth: 8.8 cm



Pro-HC
(plastic outdoor)
Height: 22.8 cm
Width: 25 cm
Depth: 10 cm

Compatible with:

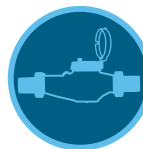

HC Flow Meter
[Page 155](#)



Soil-Clik Sensor
[Page 150](#)



Rain-Clik Sensor
[Page 148](#)

PRO-HC - SPECIFICATION BUILDER: ORDER 1 + 2 + 3 + 4							
1	Model	2	Transformer	3	Indoor/Outdoor	4	Options
	PHC-6 = 6-station controller PHC-12 = 12-station controller PHC-24 = 24-station controller		00 = 120 VAC 01 = 230 VAC		(blank) = Outdoor model (internal transformer) i = Indoor model (plug-in transformer)		(blank) = No option E = 230 VAC with European connections, no plug A = 230 VAC with Australian connections (outdoor model has internal transformer with plug)

Example:
PHC-2400 = 24-station, 120 VAC, outdoor plastic controller



Smart WaterMark
Recognised as a responsible water-saving tool

HPC

This smart and flexible control solution combines the modularity of the popular Pro-C™ Controller with the power of Hydrawise® Software.

Try Hydrawise Software today, hardware-free at hydrawise.com

KEY BENEFITS

- Number of stations:
 - Conventional wiring from 4 to 23 stations
 - Hybrid EZ Decoder option up to 32 total stations (28 stations maximum if two-wire only)
- Standard programming option allows for 6 independent irrigation programs and 6 start times per program
- Advanced programming option provides station-based programming with up to 6 total start times available
- 1 sensor input available for use with any Clik sensor or HC Flow Meter
- 1 P/MV output for pump start relay and master valve activation
- Wi-Fi enabled for quick connection to Hydrawise software
- 7 cm full-colour touchscreen display for simple programming at the control panel
- Built-in milliamp sensor for wire fault detection and alerts

OPERATING SPECIFICATIONS

- Transformer input: 120 or 230 VAC
- Transformer output (24 VAC): 1 A
- Station output (24 VAC): 0.56 A
- P/MV output (24 VAC): 0.28 A
- 2.4 GHz (only) Wi-Fi router compatible, 802.11 b/g/n 20 MHz
- Supported security protocols: WPA/WPA2 Personal (only) TLS, SSL
- Approvals: IP44 (outdoor), UL, cUL, FCC, CE, RCM, ISED
- Warranty period: 2 years

USER-INSTALLED OPTIONS

- Wireless HC Flow Meter option permits wireless flow monitoring for Hydrawise enabled systems; **see page 155**



HPC
(plastic indoor/outdoor)
Height: 22.9 cm
Width: 25.4 cm
Depth: 11.4 cm



HPC Face Panel

HPC	
Model	Description
HPC-400	4-station base: 120 VAC indoor/outdoor controller, and plug
HPC-401-E	4-station base: European 230 VAC indoor/outdoor controller, and plug
HPC-401-A	4-station base: Australian 230 VAC indoor/outdoor controller, and plug
HPC-FP	Hydrawise retrofit face panel for Pro-C Controllers (March 2014 or newer models)

PC-SERIES STATION EXPANSION	
Model	Description
PCM-300	3-station plug-in module
PCM-900	9-station plug-in module
PCM-1600	16-station plug-in module
PC-DM	EZ Decoder output module

Compatible with:

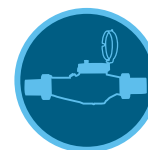

HC Flow Meter
Page 155



ROAM Remote
Page 140
ROAM XL Remote
Page 141

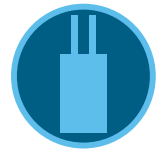

EZ Decoder System
Page 136



Smart WaterMark
Recognised as a responsible water-saving tool

HCC

Bring the power of Hydrawise® to residential, commercial, and public-sector projects with this affordable powerhouse.

Try Hydrawise Software today, hardware-free at hydrawise.com

KEY BENEFITS

- Number of stations:
 - Conventional: 8 to 38 (plastic), 8 to 54 (metal and pedestals)
 - With two-wire EZDS: up to 54 (all enclosure options)
- Any 2 programs or stations can operate simultaneously
- 2 sensor inputs available for use with any Klik sensors and HC Flow Meter
- 1 P/MV output for pump start relay and master valve activation
- 8 cm full-colour touchscreen display for simple programming at the control panel
- Built-in milliamp sensor for wire fault detection and alerts

OPERATING SPECIFICATIONS

- Transformer input: 120/230 VAC
- Transformer output (24 VAC): 1.4 A
- Station output (24 VAC): 0.56 A
- P/MV output (24 VAC): 0.56 A
- 2.4 GHz (only) Wi-Fi router compatible, 802.11 b/g/n 20 MHz
- Supported security protocols: WPA/WPA2 Personal (only) TLS, SSL
- Approvals: Plastic Wall Mount IP55 (outdoor), Plastic Pedestal IP24, UL, cUL, FCC, CE, RCM, ISED
- Warranty period: 2 years

USER-INSTALLED OPTIONS

- Wireless HC Flow Meter option permits wireless flow monitoring for Hydrawise enabled systems; **see page 155**
- Compatible with ROAM Remote and ROAM XL Remote; **see pages 140 and 141**



Plastic
Height: 30.5 cm
Width: 35 cm
Depth: 12.7 cm

Metal
(grey or stainless)
Height: 40.6 cm
Width: 33 cm
Depth: 12.7 cm



Metal Pedestal
(metal/stainless)
Height: 91.4 cm
Width: 29.2 cm
Depth: 12.7 cm



Plastic Pedestal
Height: 99 cm
Width: 61 cm
Depth: 43 cm

HCC	
Model	Description
HCC-800-PL	8-station base model, plastic outdoor, wall mount
HCC-800-M	8-station base model, grey metal outdoor, wall mount
HCC-800-SS	8-station base model, stainless steel, wall mount
HCC-800-PP	8-station base model, plastic pedestal
HCC-FPUP	Retrofit upgrade kit for ICC and ICC2
ICC-PED	Grey pedestal for metal wall mount cabinet
ICC-PED-SS	Stainless steel pedestal for stainless wall mount
ICC-PWB	Optional pedestal wiring board for metal pedestals
ANT-EXT-KIT	Universal antenna extension kit

HCC SERIES STATION EXPANSION	
Model	Description
ICM-400	4-station plug-in module with enhanced surge protection
ICM-800	8-station plug-in module with enhanced surge protection
ICM-2200	22-station expansion module (maximum one per controller)
EZDS	See page 136 for model chart

Compatible with:

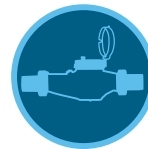

HC Flow Meter
Page 155

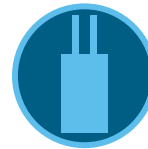

EZ Decoder System
Page 136



Rain-Klik Sensor
Page 148



Smart WaterMark
Recognised as a responsible water-saving tool

WI-FI SYSTEM OVERVIEW

Wi-Fi Controller
HPC

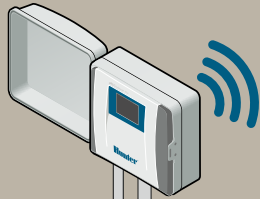

Rain Sensor
Rain-Clik™



Wi-Fi Range Extender
(if necessary)

Wi-Fi Router



Multi-Site
Manager Dashboard



OR



Remote Access with Mobile
Device or ROAM Remote

Solenoid Valves being
Monitored by Controller

Monitoring Flow
HC Flow Meter

CENTRALUS™ CONTROLLERS

CENTRALUS CONTROLLERS



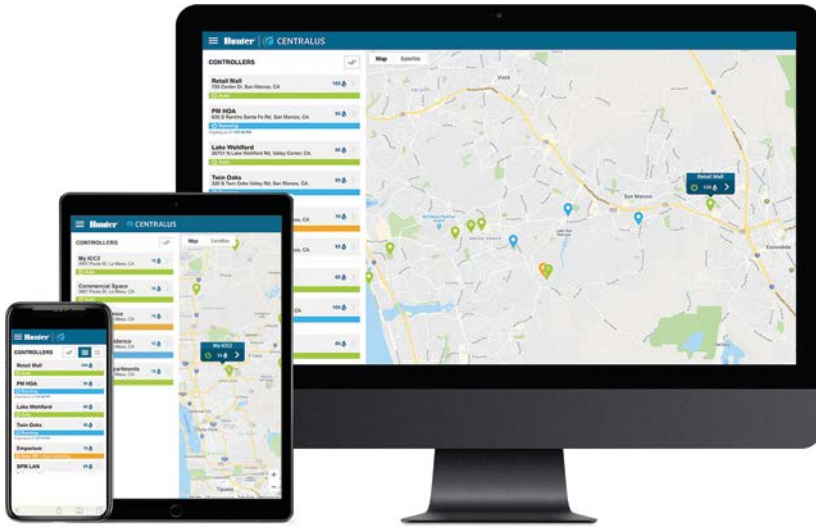

Centralus Software

Enable ICC2 and ACC2 Controllers with next-generation management technology. To learn more, visit centralus.hunterindustries.com



Smart WaterMark

Recognised as a responsible water-saving tool

Mobile-Friendly

The mobile-friendly Centralus Irrigation Management Platform provides highly secure, comprehensive cloud-based control and monitoring features. The connectivity allows you to view a controller's status, change settings, view forecasts, save water, and receive instant notification of important system alarms.

User-Friendly

The addition of internet access brings dial-based ICC2 and ACC2 Controllers seamlessly into the world of next-generation irrigation control. From the intuitive Centralus dashboard, it is now easier than ever before to add alarm monitoring, location information, remote operation, and scheduling to ICC2 and ACC2 Controllers.

Easy to Upgrade

To upgrade to Centralus control, add a simple Wi-Fi, Ethernet (LAN), or Cellular communication module to the controller:

- ICC2: Add WIFIKIT, LANKIT, or CELLKIT
- ACC2: A2C-WIFI, A2C-LAN, or A2C-CELL-E

CENTRALUS CONTROLLER COMPARISON CHART

CONTROLLER MODELS	MAXIMUM STATIONS	SENSOR INPUTS	TWO-WIRE	FLOW	REMOTE CONTROL	WEB ACCESS
ICC2	54	1 Clik or Solar Sync™	EZDS, 54 stations	Flow-Clik™ for catastrophic high-flow shutdown	ROAM, ROAM XL, Smartphone	Centralus: Wi-Fi, LAN, Cellular
ACC2	54, 225 two-wire	3 Clik, 1 Solar Sync 6 Flow	ICD, 225 stations	HFS, WFS	ROAM, ROAM XL, Smartphone	Centralus: Wi-Fi, LAN, Cellular

CENTRALUS™ SOFTWARE

Add cloud-based control and monitoring for ICC2 and ACC2 Controllers with the mobile-friendly Centralus Irrigation Management Platform.

KEY BENEFITS

- Browser-based programming and communication software
- Highly secure cloud access
- Map-based navigation and status
- Instant remote control from mobile device
- Flow monitoring and reporting
- Alarm reporting and detailed irrigation history reports
- Responsive web design configures for your device, allowing the same controls from your smartphone, tablet, or desktop
- Wi-Fi, Ethernet, or cellular connectivity options
- Manage Solar Sync™ adjustments and delay settings for greater water savings
- Organise maintenance teams and their controllers into management groups

OPERATING SPECIFICATIONS

- Operates in most modern browsers
- Secure internet connection for web-hosted application

USER-INSTALLED OPTIONS

- ET-based Solar Sync Sensor (one per controller); **see page 153**
- Flow sensors including Flow-Sync, WFS, and other approved equals
- Connected controllers are compatible with licence-free ROAM/ROAM XL Remotes (pre-wired controller connection)

COMMUNICATION OPTIONS

- Ethernet with RJ-45 connection, low data requirements
- 2.4 GHz (only) Wi-Fi router compatible, 802.11 b/g/n 20 MHz
- Supported security protocols: WPA/WPA2 Personal (only) TLS, SSL
- Cellular connectivity with ICC2 and ACC2 Controllers

COMMUNICATIONS	
Model	Description
WIFIKIT	ICC2 Wi-Fi connection
LANKIT	ICC2 LAN (Ethernet) connection
CELLKIT	ICC2 cellular connection (service plan required)
A2C-WIFI	ACC2 Wi-Fi connection
A2C-LAN	ACC2 LAN (Ethernet) connection
A2C-CELL-E	Cellular communication module for ACC2 (service plan required)

COMMUNICATIONS ACCESSORIES	
Model	Description
ANT-EXT-KIT	Universal Antenna Extension Kit



WIFIKIT
Height: 10.8 cm
Width: 6.4 cm (installed)
Depth: 3.5 cm



LANKIT
Height: 10.8 cm
Width: 6.4 cm (installed)
Depth: 3.5 cm

View Centralus Software today, at centralus.hunterindustries.com

ACC2 COMMUNICATION MODULE INSTALLATION



A2C Communication Modules are installed behind the ACC2 facepack

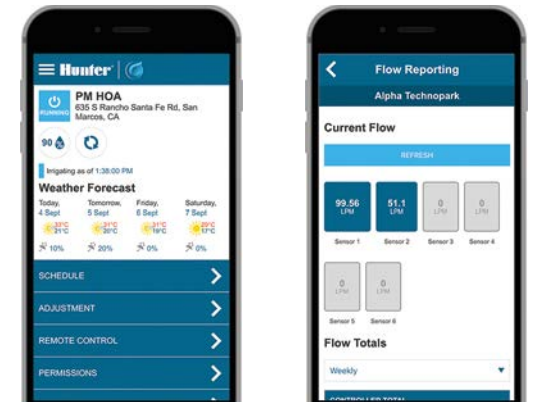

Manage and monitor controllers from anywhere

ICC2 WIFIKIT INSTALLATION



ICC2

This flexible control system can run any combination of conventional or two-wire outputs with the option to upgrade to cloud-based Centralus™ control.

View Centralus Software today, at centralus.hunterindustries.com

KEY BENEFITS

- Number of stations:
 - Conventional: 8 to 38 (plastic), 8 to 54 (metal and pedestal)
 - With two-wire EZDS: up to 54 (all enclosure options)
- 4 independent irrigation programs (8 start times each)
- Any 2 programs can operate simultaneously
- 1 sensor input available for use with Solar Sync™ or any Clik sensors
- 1 P/MV output for pump start relay and master valve activation
- Upgradeable to Centralus Software for web-based central control options

OPERATING SPECIFICATIONS

- Transformer input: 120/230 VAC
- Transformer output (24 VAC): 1.4 A
- Station output (24 VAC): 0.56 A
- P/MV output (24 VAC): 0.56 A
- Approvals: Wall Mounts IP55 (outdoor), Plastic Pedestal IP24, UL, cUL, FCC, CE, RCM, ISED
- Warranty period: 5 years

USER-INSTALLED OPTIONS

- WIFIKIT, LANKIT, or CELLKIT communications for cloud-based Centralus control
- Compatible with Flow-Clik™ Sensor for catastrophic high-flow shutdown; see page 157
- Compatible with Solar Sync Sensor; see page 153



Plastic

Height: 30.5 cm
Width: 35 cm
Depth: 12.7 cm

Metal

(grey or stainless steel)
Height: 40.6 cm
Width: 33 cm
Depth: 12.7 cm



Metal Pedestal

(grey or stainless steel)
Height: 91.4 cm
Width: 29.2 cm
Depth: 12.7 cm



Plastic Pedestal

Height: 99 cm
Width: 61 cm
Depth: 43 cm

ICC2	
Model	Description
I2C-800-PL	8-station base model, plastic outdoor wall mount
I2C-800-M	8-station base model, grey metal outdoor, wall mount
I2C-800-SS	8-station base model, stainless steel, wall mount
I2C-800-PP	8-station base model, plastic pedestal
ICC-FPUP2	ICC2 Retrofit Kit for original ICC Controllers
ICC-PED	Grey pedestal for metal controller mount
ICC-PED-SS	Stainless steel pedestal for stainless controller mount
ICC-PWB	Optional pedestal wiring board for metal pedestals

ICC2 SERIES STATION EXPANSION

Model	Description
ICM-400	4-station plug-in module with enhanced surge suppression
ICM-800	8-station plug-in module with enhanced surge suppression
ICM-2200	22-station expansion module (one per controller)
EZDS	See page 136 for model chart

Compatible with:



ROAM Remote
Page 140
ROAM XL Remote
Page 141

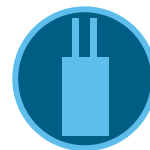

EZ Decoder System
Page 136



Solar Sync Sensor
Page 153



Smart WaterMark

Recognised as a responsible water-saving tool when used with a Solar Sync Sensor

ACC2

The multi-flow monitoring and management capabilities of ACC2, with the option to upgrade to cloud-based Centralus control, make it the best choice for complex projects.

KEY BENEFITS

- Number of stations:
 - 12 to 225, for large projects
- Up to 6 flow sensor inputs and 6 P/MV outputs
- 32 automatic programs (10 start times each) for precise plant management
- Block function to group stations and consolidate large systems
- Add a Solar Sync™ Sensor to save water based on local weather conditions
- Real-time flow monitoring detects and diagnoses leaks in up to 6 flow zones
- Flow management optimises watering at safe velocities
- High-visibility, full-colour display with reversible facepack
- Conditional Response “if/then” programming for active responses to sensor inputs
- User management password protection, with two levels of access
- Optional plug-in communications modules for cloud or network control
- Detailed alarm logs in plain language
- Extreme service lightning protection
- Easy Retrieve™ Memory programming backup and restore
- Non-Water Windows to inhibit accidental irrigation

OPERATING SPECIFICATIONS

- Transformer input: 120/230 VAC
- Maximum AC current draw: 120 VAC, 2 A/230 VAC, 1 A
- Transformer output: 24 VAC, ~3 A
- P/MV outputs (24 VAC): Up to 6; 3 included, 0.8 A each
- Sensor inputs: 3 Clik, 1 Solar Sync, and up to 6 Flow sensors (3 included)
- Approvals: Wall Mounts IP55 (outdoor), Plastic Pedestal IP24, UL, cUL, FCC, CE, RCM, ISED
- Warranty period: 5 years

USER-INSTALLED OPTIONS

- Centralus central control available with Wi-Fi, LAN, and cellular connections

View Centralus Software today,
at centralus.hunterindustries.com



Metal Wall Mount
(grey or stainless steel)
Height: 40 cm
Width: 40 cm
Depth: 18 cm



Plastic Wall Mount
Height: 42 cm
Width: 42 cm
Depth: 17 cm



Metal Pedestals
(grey or stainless steel)
Height: 94 cm
Width: 39 cm
Depth: 13 cm



Plastic Pedestal
Height: 97 cm
Width: 55 cm
Depth: 40 cm

Compatible with:



**Solar Sync
Sensor**
Page 153



**Flow-Sync
Sensor**
Page 154
WFS Sensor
Page 156



ROAM Remote
Page 140
ROAM XL Remote
Page 141



Smart WaterMark

Recognised as a responsible water-saving tool when used with a Solar Sync sensor

ADDITIONAL SPECIFICATIONS BY MODEL

ACC2 CONVENTIONAL

- Number of stations:
 - 12 to 54, for large projects
- Simultaneous station operation: up to 14 solenoids
- Expands in 6-station increments
- Extreme service lightning protection, standard on all A2M-600 Output Modules
- Station outputs: 0.8 A each

ACC2 CONVENTIONAL MODELS	
Model	Description
A2C-1200-M	12-station base unit controller, expands to 54 stations, grey steel wall mount, outdoor
A2C-1200-P	12-station base unit controller, expands to 54 stations, plastic outdoor wall mount
A2C-1200-SS	12-station base unit controller, expands to 54 stations, stainless steel wall mount, outdoor
A2C-1200-PP	12-station base unit controller, expands to 54 stations, plastic pedestal
A2M-600	6-station plug-in module for use with the A2C-1200 series controllers

ACC2 ACCESSORIES FOR ALL MODELS

ACC2 ACCESSORIES	
Model	Description
A2C-F3	Optional flow meter expansion module (adds 3 inputs)
A2C-LEDKT	External status light shows controller status with door closed
A2C-WIFI	ACC2 Wi-Fi connection
A2C-LAN	ACC2 LAN (Ethernet) connection
A2C-CELL-E	ACC2 international cell connection (monthly service plan required)
ACC-PED	Grey pedestal for wall mount
PED-SS	Stainless steel pedestal for wall mount

ACC2 DECODER

- Number of stations:
 - 75, 150, or 225, for large projects
- Simultaneous station operation: up to 30 solenoids
- Operates Hunter's premium ICD Decoders over ID wire:
 - Up to 3 km (2 mm² wire)
 - Up to 4.5 km (3 mm² wire)
- See complete ICD Decoder key benefits and specifications on [page 134](#)
- Up to 3 two-wire paths per output module
- Diagnostics including decoder inventory, wire tracker, solenoid finder, and more

ACC2 DECODER MODELS	
Model	Description
A2C-75D-M	75-station base model, grey metal outdoor, wall mount
A2C-75D-P	75-station base model, plastic outdoor, wall mount
A2C-75D-SS	75-station base model, stainless steel, wall mount
A2C-75D-PP	75-station base model, plastic pedestal
A2C-D75	75-station decoder expansion module

ACC2 REVERSIBLE FACEPACK AND AUTOMATIC DIAGNOSTIC MODE





BATTERY-OPERATED CONTROLLERS



When locations are difficult to access, lack electrical power, or demand cost-prohibitive wire runs, battery-operated controllers can make irrigation effective and affordable. Unlike traditional irrigation systems, they save time and money because there's no need to run wire, obtain construction permits, or lease equipment to tunnel under concrete or other hardscape elements. Since these systems are less intrusive, they can also help you win bids where specifications are strict about AC power requirements.

BATTERY-OPERATED CONTROLLER COMPARISON CHART

CONTROLLER MODELS	MAXIMUM STATIONS	SENSOR INPUTS	REMOTE CONTROL	SOLAR
BTT	2	N/A	BTT Bluetooth App	N/A
NODE	6	1	N/A	SPNODE
NODE-BT	4	2	NODE-BT Bluetooth App	Coming 2022
XC HYBRID	12	1	N/A	SPXCH, XCH-600-SSP, XCH-1200-SSP

Take advantage of smartphone-controlled, above-ground irrigation for easier access to the hose tap.

KEY BENEFITS

- Number of zones:
 - 1 or 2 (fixed models)
- Battery-operated tap timer with Bluetooth® control
- 1 smartphone manages an unlimited number of controllers
- 1-second to 24-hour run time with 4 start times
- Cycling mode repeats continuously within user-defined water windows, perfect for drip systems or germinating seeds
- Suspend irrigation up to 99 days during the off-season, perfect for seasonal markets
- Manual push-button operation for quick operation without a smartphone
- Automatic water shutoff after 1 hour prevents water waste
- Blinking LED low-battery alert indicates battery replacement
- Alkaline batteries included for quicker installation
- Includes quick coupler adapter

OPERATING SPECIFICATIONS

- Two 1.5V AA alkaline batteries (included)
- Flow rate: 1.9 to 2,271 L/H
- Recommended pressure: 0.5 to 8 bar (50 to 800 kPa)
- See friction loss chart on **page 258**
- Bluetooth 4.0/4.2 (BLE)
- Approvals: Plastic IPX6 (outdoor), UL, cUL, FCC, CE, RCM, ISED
- Warranty period: 2 years

APP SPECIFICATIONS

- iOS® 9.0 or above, Android™ 4.4 or above
- Maximum communication distance: 10 m
- See all app features at hunter.info/BTT



BTT-101
 Inlet diameter: ¾" and 1"
 Outlet diameter: ¾"
 Height: 16.8 cm
 Width: 12 cm
 Depth: 6 cm



BTT-201
 Inlet diameter: ¾" and 1"
 Outlet diameter: ¾"
 Height: 15.7 cm
 Width: 13.5 cm
 Depth: 7.6 cm



BTT-LOC
 (optional)
 Inlet diameter: ¾"
 Outlet diameter: 16-18 mm
 dripline
 Height: 7 cm
 Width: 3 cm



Pressure Regulator
 (optional)
 Inlet diameter: ¾"
 Outlet diameter: ¾"
 Height: 7 cm
 Width: 4 cm

BTT



To control drip irrigation applications with BTT, use the BTT-LOC Drip Adapter, which connects BTT to HDL surface and subsurface systems.

Compatible with:

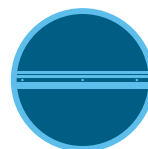

HDL Dripline
 Page 167

BTT	
Model	Description
BTT-101	1-zone Bluetooth Tap Timer, 1" BSP and ¾" hose thread, quick coupler adapter
BTT-201	2-zone Bluetooth Tap Timer, 1" BSP and ¾" hose thread, quick coupler adapter

BTT ACCESSORIES	
Model	Description
BTT-LOC	BTT adapter for 16-18 mm dripline
PRLG203FH3MH	1.4 bar (140 kPa) pressure regulator, ¾" hose thread
PRLG253FH3MH	1.7 bar (170 kPa) pressure regulator, ¾" hose thread
PRLG303FH3MH	2 bar (200 kPa) pressure regulator, ¾" hose thread
PRLG403FH3MH	2.8 bar (280 kPa) pressure regulator, ¾" hose thread

The Bluetooth® word mark and logos are registered trademarks owned by Bluetooth SIG Inc. and any use of such marks by Hunter Industries is under licence. iOS is a trademark or registered trademark of Cisco in the U.S. and other countries and is used under licence. Android is a trademark of Google LLC.

NODE

This battery-operated, waterproof controller offers automatic irrigation control for temporary irrigation and sites without electricity.

KEY BENEFITS

- Number of stations:
 - 1, 2, 4, or 6 (fixed models)
- Battery-operated controller for automatic irrigation
- Battery-life indicator for battery replacement
- Waterproof enclosure seal protects against water ingress
- 3 flexible programs with 4 start times each and up to 6-hour run times
- Suspend irrigation up to 99 days during the off-season
- Easy Retrieve™ Memory backs up the full irrigation schedule if ever changed
- Seasonal adjustment for quicker schedule adjustments without changing run times
- Solar panel provides maintenance-free operation
- Mounts to Hunter solenoids, pipes, flat surfaces, or inside the valve box

OPERATING SPECIFICATIONS

- One or two 9V alkaline batteries or 1800 mAh solar panel with charging cell
- Operates Hunter DC-Latching Solenoids; **see page 261**
- 30 m maximum wire runs, 1 mm² wire only
- Solar panel includes 12 m of direct-burial wire
- Station output: 9-11 VDC
- P/MV output: 9-11 VDC (multi-station models)
- Sensor inputs: 1 (wired rain, freeze, or wind only)
- Approvals: IP68 (submersible), UL, cUL, FCC, CE, RCM, ISED
- Warranty period: 2 years

NODE	
Model	Description
NODE-100	Single-station battery controller and DC-Latching Solenoid
NODE-100-LS	Single-station battery controller
NODE-200	2-station battery controller
NODE-400	4-station battery controller
NODE-600	6-station battery controller
NODE-100-VALVE	Single-station battery controller with PGV-101G Valve and DC-Latching Solenoid (NPT threads)
NODE-100-VALVE-B	Single-station battery controller with PGV-101G-B Valve and DC-Latching Solenoid (BSP threads)
SPNODE	Solar panel kit for NODE controllers
458200	DC-Latching Solenoid (for all Hunter valves)



NODE
Height: 6.4 cm
Diameter: 8.9 cm



SPNODE
Solar Panel Kit (optional)
Height: 8 cm
Length: 25 cm
Width: 8 cm
Controller to solar panel: 30 m maximum
1 mm² direct-burial wire

NODE



Compatible with:



**Mini-Clik
Sensor**
Page 149



**Freeze-Clik
Sensor**
Page 151



**Waterproof
Wire Connector**
Page 139

NODE-BT

Manage gardens, greenhouses, traffic medians, and temporary irrigation sites from a smartphone without opening the valve box.

KEY BENEFITS

- Number of stations:
 - 1, 2, or 4 (fixed models)
- Bluetooth® battery-operated controller for automatic irrigation
- 1 smartphone manages an unlimited number of controllers
- Waterproof enclosure seal protects against water ingress
- Active station LEDs and battery-life LED indicator for replacement
- 3 programs with 8 start times each and 1 second to 12-hour run times
- Suspend irrigation up to 99 days during the off-season
- Manual push-button operation for quick operation without a smartphone
- Delay Between Stations for slow-closing valves or pump recharge
- Soil moisture sensor prevents water waste; **see page 150**
- Cycle and Soak prevents water waste and runoff in areas with elevation changes or tight soils
- Monthly and global seasonal adjustment for quicker schedule adjustments without changing run times
- Solar recharging option available in 2022
- Mounts to Hunter solenoids, pipes, flat surfaces, or inside the valve box

OPERATING SPECIFICATIONS

- One or two 9V alkaline batteries
- Operates Hunter DC-Latching Solenoids; **see page 261**
- 30 m maximum wire runs, 1 mm² wire only
- Station output: 9-11 VDC
- P/MV output: 9-11 VDC (multi-station models)
- Sensor inputs: 2 (wired rain, freeze, or wind only)
- Bluetooth 5.0 (BLE)
- Approvals: IP68 (submersible), UL, cUL, FCC, CE, RCM, ISED
- Warranty period: 2 years

APP SPECIFICATIONS

- iOS® 9.0 or above, Android™ 5.0 or above
- Maximum communication distance: 15 m
- See all app features at hunter.info/NodeBT

NODE-BT	
Model	Description
NODE-BT-100	Single-station Bluetooth battery controller and DC-Latching Solenoid
NODE-BT-100-LS	Single-station Bluetooth battery controller
NODE-BT-200	2-station Bluetooth battery controller
NODE-BT-400	4-station Bluetooth battery controller
NODE-BT-100-VALVE	Single-station Bluetooth battery controller with PGV-101G Valve and DC-Latching Solenoid (NPT threads)
NODE-BT-100-VALVE-B	Single-station Bluetooth battery controller with PGV-101G-B Valve and DC-Latching Solenoid (BSP threads)
SC-PROBE	Soil probe for moisture sensing (module is not used)
458200	DC-Latching Solenoid

The Bluetooth® word mark and logos are registered trademarks owned by Bluetooth SIG Inc. and any use of such marks by Hunter Industries is under licence. iOS is a trademark or registered trademark of Cisco in the U.S. and other countries and is used under licence. Android is a trademark of Google LLC.



NODE-BT
Height: 8.3 cm
Diameter: 8.9 cm



SC-PROBE Soil Moisture Sensor Probe (optional)
Height: 8.3 cm
Diameter: 2.5 cm
Controller to probe: 30 m maximum
1 mm² direct-burial wire

NODE-BT

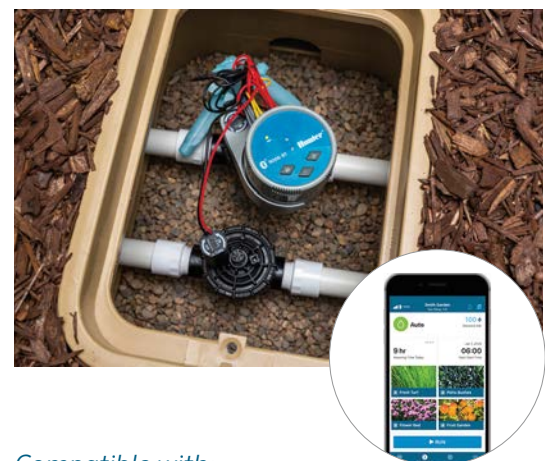

Compatible with:



**Mini-Clik
Sensor**
Page 149



**Freeze-Clik
Sensor**
Page 151



**Waterproof Wire
Connector**
Page 139

XC HYBRID

Effectively manage landscapes where electricity is unavailable with this economical battery-operated or solar-powered controller.

KEY BENEFITS

- Number of stations:
 - 6 or 12 (fixed models)
- 3 power options: AC power, battery, or solar panel compatible with ambient light
- Stainless steel enclosure protects against vandalism
- 3 programs with 4 start times each and up to 4-hour run times
- Suspend irrigation up to 99 days during the off-season
- Easy Retrieve™ Memory backs up the full irrigation schedule
- Delay Between Stations for slow-closing valves or pump recharge
- Seasonal adjustment for quicker schedule adjustments without changing run times
- Solar panel provides maintenance-free operation
- Mounts to flat surfaces or steel posts

OPERATING SPECIFICATIONS

- Plastic model operates six 1.5V AA alkaline batteries
- Stainless steel model operates six 1.5V C alkaline batteries
- Stainless steel solar model operates 1800 mAh solar panel with charging cell
- Solar panel includes 12 m of direct-burial wire
- Controller to solar panel: 30 m maximum 1 mm² direct-burial wire
- All models operate optional 24 VAC plug-in wall adapter:
 - 120 VAC P/N 526500
 - 230 VAC Australian P/N 545500
 - 230 VAC European P/N 545700
- Operates Hunter DC-Latching Solenoids; **see page 261**
- Station output: 9-11 VDC
- P/MV output: 9-11 VDC
- Sensor inputs: 1 (wired rain, freeze, or wind only)
- Approvals: Plastic IP54 (outdoor), Stainless Steel IP24 (outdoor), UL, cUL, FCC, CE, RCM, ISED
- Warranty period: 2 years



Plastic
Height: 22 cm
Width: 18 cm
Depth: 10 cm



Stainless Steel
Height: 25 cm
Width: 19 cm
Depth: 11 cm



Stainless Steel Solar
Height: 27 cm
Width: 19 cm
Depth: 11 cm



SPXCH
Solar Panel Kit (optional)
Height: 8 cm
Length: 25 cm
Width: 8 cm



XCHSPB
Mounting bracket and hardware only (optional)



XCHSPOLE
Pole-Mounting Kit (optional)
Height: 1.2 m

Compatible with:

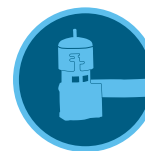

Mini-Clik Sensor
Page 149



Freeze-Clik Sensor
Page 151

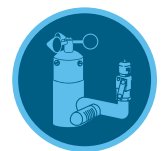

MWS Sensor
Page 152

XC HYBRID	
Model	Description
XCH-600	6-station battery controller
XCH-600-SS	6-station battery controller, stainless steel
XCH-600-SSP	6-station controller, stainless steel, with mounted solar panel
XCH-1200	12-station battery controller
XCH-1200-SS	12-station battery controller, stainless steel
XCH-1200-SSP	12-station controller, stainless steel, with mounted solar panel
DCREL2	Latching sensor relay switch for pumps
458200	DC-Latching Solenoid (for all Hunter valves)

MAXIMUM WIRE RUNS

Wire Size	Max. Distance (m)
1.0 mm ²	168
1.2 mm ²	265
1.6 mm ²	420
2.0 mm ²	670

CONTROLLER DECODERS & ACCESSORIES

CONTROLLER DECODERS & ACCESSORIES





ICD

Hunter's premium two-wire decoders for long-distance, high-station-count ACC2 applications include two-way communications and integrated surge protection.

KEY BENEFITS

- ICD Decoders are compatible with ACC2 Decoder Controllers and legacy ACC-99D Decoder Controllers
- 1-, 2-, 4-, and 6-station versions provide maximum flexibility
- Sensor decoders allow flow and Clk sensor monitoring via the two-wire paths
- Field-programmable decoders accept station numbers directly, and do not require entering serial numbers into the control panel
 - Decoders can be programmed before installation at the controller interface
 - Wireless programming with ICD-HP allows for decoder programming or re-programming after installation to the two-wire path
- Integrated surge protection eliminates the need for extra surge protection devices
- Colour-coded wiring connections simplify installation
- Industrial-grade DBRY-6 waterproof connectors included for two-wire path splices

OPERATING SPECIFICATIONS

- Maximum recommended distance, decoder to solenoid: 45 m
- Maximum distance to decoder via two-wire path:
 - 2 mm² wire path: 3 km
 - 3.3 mm² wire path: 4.5 km
- Approvals: UL, cUL, FCC, CE, RCM
- Decoder rating: IP68 (submersible)
- Warranty period: 5 years

USER-INSTALLED OPTIONS

- Wireless handheld ICD-HP Programmer; **see page 135**
- DECSTAKE10 Universal Decoder Stake Kit, 10-pack; **see page 138**



ICD-100, 200, ICD-SEN

Height: 92 mm
Width: 38 mm
Depth: 12.7 mm

ICD-400, 600

Height: 92 mm
Width: 46 mm
Depth: 38 mm

DECODER MODELS

Model	Description
ICD-100	Single-station decoder with surge suppression and ground wire
ICD-200	2-station decoder with surge suppression and ground wire
ICD-400	4-station decoder with surge suppression and ground wire
ICD-600	6-station decoder with surge suppression and ground wire
ICD-SEN	2-input sensor decoder with surge suppression and ground wire

ID WIRE MODEL GUIDE

2 mm ² Decoder Cable		3.3 mm ² Long-Range, Heavy-Duty Decoder Cable	
ID1GRY	Grey jacket	ID2GRY	Grey jacket
ID1PUR	Purple jacket	ID2PUR	Purple jacket
ID1YLW	Yellow jacket	ID2YLW	Yellow jacket
ID1ORG	Orange jacket	ID2ORG	Orange jacket
ID1BLU	Blue jacket	ID2BLU	Blue jacket
ID1TAN	Tan jacket	ID2TAN	Tan jacket

ID WIRE MAXIMUM WIRE RUNS

ID 1 Wire	ID 2 Wire
1500 m with legacy DUAL™ systems	2300 m with legacy DUAL systems
3 km with ICD systems	4.5 km with ICD systems

Compatible with:



**Waterproof
Splice Kit**
Page 139

ICD-HP PROGRAMMER

Gain wireless, handheld programming and diagnostic capabilities for Hunter ICD and DUAL™ Decoders.

KEY BENEFITS

- Program or re-program decoder stations, whether new or installed*
- Program any station numbers in any order, or skip stations for future expansion
- Simplifies setup and diagnostics for sensor decoders
- Sensor test functions for Clik and Flow sensors, plus built-in multimeter
- Communicates with decoder through plastic case: wireless electromagnetic induction saves waterproof connectors
- Compatible with Hunter ICD and legacy DUAL Decoders, as well as Pilot™ Two-Way Modules
- USB powered for shop or office use; 4 AA batteries for field use
- All test leads and cables included in durable, foam-padded carrying case
- Turn decoder stations on and view solenoid status, current in milliamps, and more
- Waterproof programming cup
- Backlit adjustable display
- 6 operating languages
- * **Note:** ICD-HP is not compatible with EZ-1 Decoders

ELECTRICAL SPECIFICATIONS

- Power input: 4 AA batteries, or standard USB connector (included)
- Communications: wireless induction, range 25 mm
- Fused test leads for unpowered decoder functions

APPROVALS

- UL, cUL, FCC, CE, RCM

ICD-HP	
Model	Description
ICD-HP	Wireless handheld decoder programmer, includes all test and power leads, programming cup, and rugged carrying case



ICD-HP

Height: 21 cm
Width: 9 cm
Depth: 5 cm

Packaged in an outdoor carrying case, this complete kit includes probes, induction cup, cable, USB power cable for bench use, and 4 AA batteries for fieldwork.

ICD-HP



EZ DECODER SYSTEM

Bring two-wire technology to more projects than ever before with the revolutionary, low-cost, and hassle-free EZ Decoder System for Pro-C™, HPC, ICC2, and HCC Controllers.

KEY BENEFITS

- Number of stations:
 - Pro-C/HPC: Up to 28, plus master valve
 - ICC2/HCC: Up to 54, plus master valve
- No special wire or connectors required
- No special grounding or surge arrestors required in-line
- Programmable decoders with no need to input individual serial numbers
- P/MV can activate via the two-wire path for distant installations
- EZ-1 Decoders have built-in status LED for positive diagnostics

OPERATING SPECIFICATIONS

- Electrical output on two-wire path: 24 VAC, 50/60 Hz
- Two-wire paths to the field:
 - EZ-DM: 2
 - PC-DM: 1
- Wire paths possible up to 1 km (see Wiring Table below)
- Each EZ-1 Decoder can activate two standard 24 VAC solenoids
- Operate any two decoders simultaneously for more efficient watering (ICC2 and HCC only)
- Approvals: UL, cUL, FCC, CE, RCM, ISED
- EZ-1 Decoders are IP68 rated, submersible
- Warranty period: 3 years

USER-INSTALLED OPTIONS

- Centralus™ with ICC2
- Hydrowise® with HPC and HCC
- EZ-DT EZ Decoder Diagnostic Tool for wireless diagnostics with EZ-1 Decoders
- DECSTAKE10 Universal Decoder Stake Kit, 10-pack; [see page 138](#)
- Compatible with Waterproof Wire Connector; [see page 139](#)

WIRING TABLE

International Wire Gauge (mm ²)	Distance, single solenoid (m)	Distance, 2 solenoids per output
0.5 mm ²	167	83
0.8 mm ²	267	133
1 mm ²	333	167
1.5 mm ²	500	250
2.5 mm ²	833	417
4 mm ²	1,333	667

Note

Distances in the Wiring Table are calculated based on 50 Hz with a wire temperature of 50°C and a 10% safety factor.

DECODER MODELS

Model	Description
EZ-DM	Decoder output module for ICC2 and HCC Controllers
PC-DM	Decoder output module for Pro-C and HPC Controllers
EZ-1	Single-station decoder with status LED
EZ-DT	EZ Decoder Diagnostic Tool



Single-Station Decoder

Height: 73 mm
Width: 42 mm
Depth: 16 mm

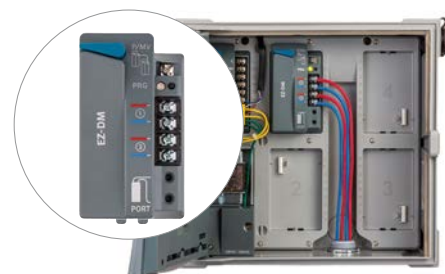

Decoder Output Module: EZ-DM

Height: 115 mm
Width: 64 mm
Depth: 42 mm



Decoder Output Module: PC-DM

Height: 76 mm
Width: 76 mm
Depth: 32 mm

Compatible with:



HCC Controller
Page 118



ICC2 Controller
Page 123

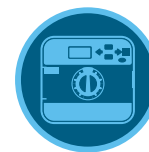

Pro-C Controller
Page 109

EZ-DT

Simplify maintenance of EZ Decoder Systems with the handheld, wireless EZ Decoder Diagnostic Tool.

KEY BENEFITS

- Wireless, handheld diagnostic tool for EZ-1 Decoders
- Detect faults and perform electrical troubleshooting in the field without uninstalling decoders
- Quickly read decoder status, station address, current draw, and two-wire voltage to simplify maintenance
- Program decoder station address via the wired connection to speed up installation and save time on-site
- Update controller facepack or decoder module firmware via ribbon cable connection for flexibility when updating systems
- Communicate in your preferred language using the multilingual user interface
- Work reliably and efficiently on the go with power supplied by 4 AAA batteries

OPERATING SPECIFICATIONS

- Power input: 4 x AAA batteries (included)
- Communications: Wireless induction, 25 mm range from decoder to EZ-DT
- 46 mm full-colour, backlit TFT display

USER-INSTALLED OPTIONS

- Centralus™ with ICC2
- Hydrowise® with HCC and HPC
- Pro-C™
- DECSTAKE10 Universal Decoder Stake Kit, 10-pack; see page 138

DECODER MODELS

Model	Description
EZ-DM	Decoder output module for ICC2 and HCC Controllers
PC-DM	Decoder output module for Pro-C and HPC Controllers
EZ-1	Single-station decoder with status LED
EZ-DT	EZ Decoder Diagnostic Tool



EZ Decoder Diagnostic Tool

Height: 197 mm
Width: 70 mm
Depth: 22 mm

EZ-DT DECODER DIAGNOSTIC TOOL



Compatible with:



HCC Controller
Page 118



ICC2 Controller
Page 123

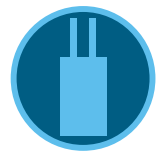

EZ Decoder System
Page 136

UNIVERSAL DECODER STAKE KIT

The Universal Decoder Stake Kit raises the decoder off the ground to keep two-wire installations organised, clean, and easily accessible during routine maintenance.

KEY BENEFITS

- Raises decoder off the ground, so contractors don't have to dig the device out of the mud
- Holds Hunter decoders in end-up position for convenient access and wireless programming without removal
- Works with all Hunter decoders and most other brands, so contractors only need to stock one item
- Zip ties conveniently included to secure the stake during installation
- Sturdy construction ensures the stake won't break or bend when hammered into the dirt
- Made primarily from recycled materials with minimal packaging to prevent waste and minimise carbon footprint

OPERATING SPECIFICATIONS

- Fits all Hunter decoders and most other brands
- Zip ties included
- Made of recycled materials

Universal Decoder Stake Kit

Height: 27.5 cm



UNIVERSAL DECODER STAKE KIT

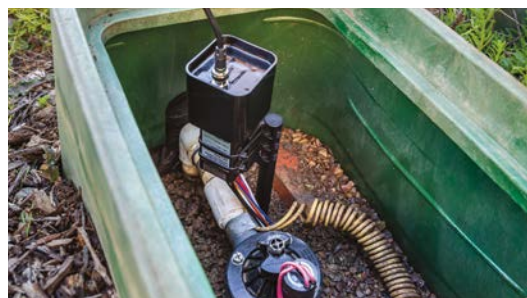

UNIVERSAL DECODER STAKE KIT

Model	Description
DECSTAKE10	Universal Decoder Stakes (10 per carton), zip ties included

ANTENNA EXTENSION KITS

Use these flexible Antenna Extension Kits when buildings, terrain, or other obstructions prevent reliable wireless communications.

KEY BENEFITS

- Universal Antenna Extension Kit option for Wi-Fi and cellular communications (ANT-EXT-KIT)
 - Wi-Fi: HCC Controller, A2C-WIFI
 - Cell: A2C-CELL-E
- For ROAM XL Remotes, extend the receiver antenna up to 7.6 m with a convenient extension cable (ROAMXL-EXT)
- Simplify Plastic Pedestal installations with a flexible pedestal lid mounting option (PED-LID-ANT-BRKT)



ROAMXL-EXT

ANTENNA EXTENSION OPTIONS

Model	Description
ANT-EXT-KIT	Universal Antenna Extension Kit for Wi-Fi and cellular communication hardware (2.7 m cable and mounting hardware)
ROAMXL-EXT	ROAM XL Antenna Extension Kit (7.6 m cable and mounting hardware)
PED-LID-ANT-BRKT	Plastic Pedestal Antenna Mount

WATERPROOF WIRE CONNECTOR

Use this approved waterproof connector for EZ Decoder and all above-grade solenoid and sensor wiring connections.

KEY BENEFITS

- 100% silicone-based sealant protects against moisture and corrosion
- Designed as a single-use only connection
- UL Listed for 600 V and 486G for use in damp/wet locations or above-grade applications
- Easy to apply, pre-filled twist-on wire connectors
- Eliminates the need for heat-shrink or excessive taping
- Not for use in continual submersion applications, use DBRY-6
- Approvals: UL, cUL, FCC, CE, RCM, RoHS, ISED

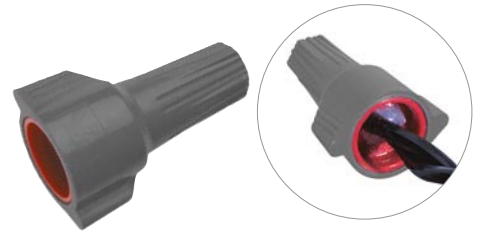

Waterproof Wire Connector

Height: 3.5 cm
 Minimum wire: 3 #0.8 mm²
 Maximum wire: 2 #6 mm² with 1 #3 mm²

WIRE CONNECTOR	
Model	Description
WC100	Bulk 100 connectors in canister

WC100 WIRE CONNECTOR



WATERPROOF SPLICE KIT

Use this approved splice kit for all direct-burial two-wire ICD and legacy DUAL™ Decoder wiring connections, as well as Pilot™ Two-Way Modules.

KEY BENEFITS

- UL Listed for 600 V and 486D for use in damp/wet location or direct-burial applications
- Waterproof, corrosion-proof, UV-rated, and impact resistant
- Snap-fit lid provides strain relief and three-wire exits
- Pre-filled with silicone that never hardens
- Two part system includes red/yellow winged wire connector and silicone-filled tube
- Compatible with EZ Decoder connections, but not a requirement
- Approvals: UL, cUL, FCC, CE, RCM, RoHS, ISED



Waterproof Splice Kit

Height: 9.5 cm
 Minimum wire: 2-7 #0.8 mm²
 Maximum wire: 2-3 #6 mm²

DBRY-6 SPLICE KIT	
Model	Description
DBRY100	Bulk 100 connectors (100 tubes loose in box, plus inner box with 100 Wire Nuts)
DBRY2X25	25 x 2-packs (2 tubes and 2 Wire Nuts in a plastic bag, x 25 units)

DBRY-6 WATERPROOF SPLICE KIT



ROAM REMOTE

Enable convenient controller management from a distance with this handheld wireless remote.

KEY BENEFITS

- Compatibility with Hunter X-Core™, X2™, Pro-C™, HPC, ICC2, HCC, ACC2, and legacy ACC and I-Core™ Controllers to enable remote management for projects of any size
- Manually start individual stations or programs for quick maintenance checks and troubleshooting
- 128 programmable addresses available prevents cross-communication between multiple remotes within close proximity of each other
- Programmable run times from 1 to 90 minutes, which will not overwrite regular automatic programming
- Manual operation up to 240 stations provides flexibility for larger projects

OPERATING SPECIFICATIONS

- Range: 300 m from transmitter to receiver
- Transmitter power source: 4 x AAA batteries included
- Receiver power source: 24 VAC, 0.010 A
- System operating frequency: 433 MHz
- SmartPort™ installation: Maximum 15 m from controller
- FCC and CE approved for use in the United States and internationally
- Warranty period: 2 years



ROAM XL Transmitter and Receiver

Height: 18 cm
Width: 6 cm
Depth: 3 cm



SmartPort

Hunter remotes require the installation of a SmartPort Wiring Harness. The SmartPort is a connector that is wired to the terminals on the controller, and allows quick connection to any Hunter receiver.



Wall-Mount Bracket for SmartPort

P/N 258200

ROAM	
Model	Description
ROAM-KIT	Transmitter, receiver, SmartPort Wiring Harness, and 4 AAA batteries included
ROAM-R	Receiver unit
ROAM-TR	Transmitter unit and 4 AAA batteries included

USER-INSTALLED OPTIONS	
Model	Description
ROAM-WH	SmartPort Wiring Harness (length: 1.8 m)
ROAM-SCWH	Shielded SmartPort Wiring Harness (length: 7.6 m)
258200	Wall-mount bracket for SmartPort

ROAM XL REMOTE

Add professional, licence-free remote control to projects of any size with this long-range remote.

KEY BENEFITS

- Compatibility with Hunter X-Core™, X2™, Pro-C™, HPC, ICC2, HCC, ACC2, and legacy ACC and I-Core™ Controllers to enable remote management for projects of any size
- Manually start individual stations or programs for quick maintenance checks and troubleshooting
- 128 programmable addresses available prevents cross-communication between multiple remotes within close proximity of each other
- Programmable run times from 1 to 90 minutes, which will not overwrite regular automatic programming
- Manual operation up to 240 stations provides flexibility for larger projects
- Rugged and water-resistant transmitter includes a large LCD display with simple push-button operation and a battery-life indicator

OPERATING SPECIFICATIONS

- Range: 3 km (line of sight) from transmitter to receiver
- Transmitter power source: 4 x AAA batteries included
- Receiver power source: 24 VAC, 0.010 A
- System operating frequency: 27 MHz
- SmartPort™ installation: Maximum 15 m from controller
- FCC approved (not available in EU and some other countries, check local regulations)
- Warranty period: 3 years

ROAM XL	
Model	Description
ROAMXL-KIT	Transmitter, receiver, SmartPort Wiring Harness, 4 AAA batteries and plastic carrying case included
ROAMXL-R	Receiver unit (SmartPort Wiring Harness included)
ROAMXL-TR	Handheld transmitter and 4 AAA batteries included

USER-INSTALLED OPTIONS

Model	Description
258200	Wall-mount bracket for SmartPort
ROAM-WH	SmartPort Wiring Harness (length: 1.8 m)
ROAM-SCWH	Shielded SmartPort Wiring Harness (length: 7.6 m)
ROAMXL-EXT	ROAM XL Antenna Extension Kit (7.6 m cable and mounting hardware included)



ROAM XL Transmitter and Receiver

(without antenna)

Height: 16 cm

Width: 8 cm

Depth: 3 cm



SmartPort

Hunter remotes require the installation of a SmartPort Wiring Harness. The SmartPort is a connector that is wired to the terminals on the controller, and allows quick connection to any Hunter receiver.



Wall-Mount Bracket for SmartPort

P/N 258200

PSR

This reliable and economical Pump Start Relay family is perfect for systems that require pump activation.

KEY BENEFITS

- Pump Start Relay family for a variety of voltage and power requirements
- 24 VAC flying leads make connection to the controller quick and easy
- Suitable for conventional wiring or two-wire decoder activation

OPERATING SPECIFICATIONS

- Recommended installation: Minimum 4.5 m from irrigation controller; see chart on **page 259** for maximum distances
- Approvals: IP44 (outdoor), UL, cUL, FCC, CE, RCM, ISED
- Warranty period: 2 years



Pump Start Relay

Height: 17 cm
Width: 19 cm
Depth: 12 cm

PUMP START RELAY

Model Description

PSR-22	Double-pole/single-throw Pump Start Relay for 120 VAC pumps up to 1.5 kW or 230 VAC pumps up to 2.2 kW
PSR-52	Double-pole/single-throw Pump Start Relay for 120 VAC pumps up to 2.2 kW or 230 VAC pumps up to 5.6 kW
PSR-53	Triple-pole/single-throw Pump Start Relay for 120 VAC pumps up to 2.2 kW, 230 VAC pumps up to 5.6 kW, or 230 VAC pumps up to 7.5 kW (3-phase)

PUMP START RELAY ELECTRICAL SPECIFICATIONS

Model	Single-Phase		3-Phase**	Max. Full Load AMPS	Max. Resistive AMPS	Coil VA				Coil VA			
	kW AT 120 VAC	kW AT 230 VAC				kW AT 230 VAC	INRUSH		AMPS		HOLDING		AMPS
				50 Hz	60 Hz	50 Hz	60 Hz	50 Hz	60 Hz	50 Hz	60 Hz	50 Hz	60 Hz
PSR-22	1.5*	2.2*	N/A	30	40	33	30	1.38	1.25	8	6.5	0.33	0.27
PSR-52	2.2	5.6	N/A	40	50	65	60	2.71	2.50	7.5	5	0.31	0.21
PSR-53	2.2	5.6	7.5	40	50	65	60	2.71	2.50	7.5	5	0.31	0.21

Note: *Approximate power

** 3-phase power at 230 VAC is not commonly available in some international markets. Check local electrical codes for compatibility.

PSR-B

For distant pump starts that require more power, choose the PSR-B.

KEY BENEFITS

- Provides a solution for pump start relay installations that have insufficient power to activate the pump
- Includes solid state relay and local 24 VAC transformer for simple PSR activation

OPERATING SPECIFICATIONS

- Primary AC power input: 120/230 VAC,
- Secondary AC power output: 24 VAC, 1.6 A
- Relay rating: Double-pole, double-throw solid state (10 A)
- Approvals: IP54 (outdoor), UL, cUL, FCC, CE, RCM, ISED
- Warranty period: 2 years



PSR-B Pump Start Relay Booster

Height: 22 cm
Width: 18 cm
Depth: 9.5 cm

PUMP START RELAY BOOSTER

Model Description

PSR-B	Use to boost controller output power for Pump Start Relays
-------	--

CONNECT YOUR WAY

Choose from a range of Wi-Fi, LAN (Ethernet), and cellular connection accessories to enable remote irrigation management on standalone controllers anytime, anywhere.

Controller

Compatible Accessories

X2



X2 Controller with WAND Module installed



WAND
Wi-Fi accessory for X2
Controllers, managed by
Hydrawise Software
page 115

ICC2

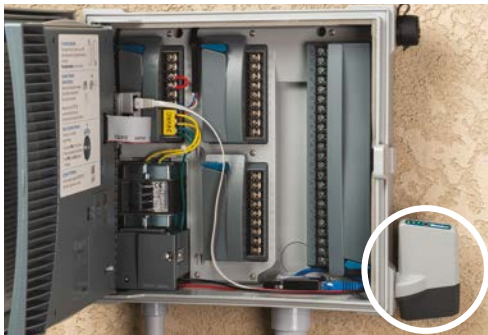

ICC2 Controller with LANKIT Module installed



WIFIKIT
Wi-Fi accessory for ICC2
Controllers, managed by
Centralus Software
page 122



LANKIT
Ethernet accessory for ICC2
Controllers, managed by
Centralus Software
page 122



CELLKIT
Cellular accessory for ICC2
Controllers, managed by
Centralus Software
page 122

ACC2



ACC2 Controller with A2C-CELL-E Module installed



A2C-WIFI
Wi-Fi accessory for ACC2
Controllers, managed by
Centralus Software
page 125



A2C-LAN
Ethernet accessory for ACC2
Controllers, managed by
Centralus Software
page 125



A2C-CELL-E
Cellular accessory for ACC2
Controllers, managed by
Centralus Software
page 125



SENSORS



SENSOR AND CONTROLLER COMPATIBILITY CHART

AC CONTROLLERS	SENSOR INPUTS	RAIN	SMART WEATHER ADJUST	FLOW	HIGH-FLOW SHUTOFF
ECO LOGIC page 106	1	Mini-Click, Rain-Click	N/A	N/A	Flow-Click
X-CORE page 107	1	Mini-Click, Rain-Click	Solar Sync	N/A	Flow-Click
X2 page 108	1	Mini-Click, Rain-Click	Hydrawise Software	N/A	Flow-Click
PRO-C page 109	1	Mini-Click, Rain-Click	Solar Sync	N/A	Flow-Click
HC page 114	2	Mini-Click, Rain-Click	Hydrawise Software	HC Flow Meter	HC Flow Meter
HPC page 117	1	Mini-Click, Rain-Click	Hydrawise Software	HC Flow Meter	HC Flow Meter
PRO-HC page 116	2	Mini-Click, Rain-Click	Hydrawise Software	HC Flow Meter	HC Flow Meter
HCC page 118	2	Mini-Click, Rain-Click	Hydrawise Software	HC Flow Meter	HC Flow Meter
ICC2 page 123	1	Mini-Click, Rain-Click	Centralus Software, Solar Sync	N/A	Flow-Click
ACC2 page 124	1 Solar Sync, 3 Click, 6 Flow	Mini-Click, Rain-Click	Centralus Software, Solar Sync	Flow-Sync, WFS, HC Flow Meter, Other (K-Factor or Scaled Pulse)	Built-in Real-Time Flow Monitoring
BATTERY-OPERATED CONTROLLERS					
NODE page 129	1	Mini-Click, Rain-Click	N/A	N/A	N/A
NODE-BT page 130	2	Mini-Click, Rain-Click	N/A	N/A	N/A
XC HYBRID page 131	1	Mini-Click, Rain-Click	N/A	N/A	N/A

SOIL MOISTURE	FREEZE	WIND
Soil-Clik	Freeze-Clik, WRF-Clik	Wind-Clik, MWS
Soil-Clik	Freeze-Clik, WRF-Clik	Wind-Clik, MWS
Soil-Clik	Freeze-Clik, WRF-Clik, Online Forecast Option	Wind-Clik, MWS, Online Forecast Option
Soil-Clik	Freeze-Clik, WRF-Clik	Wind-Clik, MWS
Soil-Clik	Freeze-Clik, WRF-Clik, Online Forecast Option	Wind-Clik, MWS, Online Forecast Option
Soil-Clik	Freeze-Clik, WRF-Clik, Online Forecast Option	Wind-Clik, MWS, Online Forecast Option
Soil-Clik	Freeze-Clik, WRF-Clik, Online Forecast Option	Wind-Clik, MWS, Online Forecast Option
Soil-Clik	Freeze-Clik, WRF-Clik, Online Forecast Option	Wind-Clik, MWS, Online Forecast Option
Soil-Clik	Freeze-Clik, WRF-Clik, Online Forecast Option	Wind-Clik, MWS
Soil-Clik	Freeze-Clik, WRF-Clik, Online Forecast Option	Wind-Clik, MWS
N/A	Freeze-Clik	N/A
SC-Probe	Freeze-Clik	N/A
N/A	Freeze-Clik	N/A



Rain-Clik™



Mini-Clik™



Soil-Clik™



Freeze-Clik™



Freeze-Clik™



MWS



Solar Sync™



Flow-Sync™



HC Flow Meter
Available wireless!



WFS



Flow-Clik™

RAIN-CLIK™

Sensor: Rain, Freeze

To prevent water waste, built-in Quick Response™ Technology instantly shuts down irrigation as soon as it starts raining.

KEY BENEFITS

- Quick Response Technology triggers instant rain shutoff
- Freeze sensing model halts system operation at 3°C
- Wireless sensor kit simplifies installation
- Maintenance-free design with integrated battery for wireless models
- Adjustable vent ring allows for shorter or longer reset period
- Includes gutter bracket and wall mount with wireless models
- Compatible with most normally open or normally closed irrigation controllers

OPERATING SPECIFICATIONS

- Quick Response Technology:
 - Time to turn off irrigation system: approximately 2 to 5 minutes for Quick Response
 - Time to reset Quick Response: approximately 4 hours under dry, sunny conditions
 - Time to reset when fully wet: approximately 3 days under dry, sunny conditions
- All models switch rating (24 VAC): 3 A
- Wired models include 7 m of 0.5 mm² sheathed, UL-approved wire
- Wireless model operating frequency: 433 MHz
- Wireless model range is 243 m line of sight from sensor to receiver
- Multiple wireless receivers can be operated from a single wireless sensor
- Approvals: UL, cUL, FCC, CE, RCM
- Warranty period: 5 years

USER-INSTALLED OPTIONS

- Optional Gutter Mount for wired models (included with WR-CLIK and WRF-CLIK)
- Vandal-resistant Wireless Sensor Guard for flat surfaces or pole mounting (order sensor separately)
- Vandal-resistant Wireless Receiver Guard for pedestal mounting (order receiver separately)

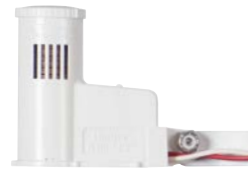

Wired Rain-Clík Sensor
(with mounting arm)
Height: 6 cm
Length: 18 cm
Width: 2.5 cm



SGM
Height: 1.2 cm
Length: 7.6 cm
Width: 1.2 cm



Wireless Rain-Clík Sensor
(with mounting arm)
Height: 7.6 cm
Length: 20 cm
Width: 2.5 cm



Wireless Receiver
(with wall mounting hardware)
Height: 8 cm
Length: 10 cm
Width: 3 cm



Wireless Sensor Guard
(with mounting hardware)
Height: 7 cm
Length: 9.5 cm
Width: 3.2 cm



Wireless Receiver Guard
(with mounting hardware)
Height: 12.7 cm
Length: 10.2 cm
Width: 3.2 cm

RAIN-CLIK	
Model	Description
RAIN-CLIK	Wired Rain-Clík Sensor
RAIN-CLIK-NO	Wired Rain-Clík Sensor, normally open switch
RFC	Wired Rain/Freeze-Clík Sensor
WR-CLIK	Wireless Rain-Clík Sensor and Receiver, and Gutter Mount
WRF-CLIK	Wireless Rain/Freeze-Clík Sensor and Receiver, and Gutter Mount

Compatible with:



Waterproof Wire Connector
Page 139



Smart WaterMark
Recognised as a responsible water-saving tool

MINI-CLITM

Sensor: **Rain, Freeze**

This sensor halts scheduled irrigation when it detects a preset level of rain has fallen to stop water waste.

KEY BENEFITS

- Shuts off irrigation automatically when the sensor detects rainfall from 3 mm to 19 mm
- Debris tolerant for reliable operation and no unnecessary shutdowns
- Compatible with most normally open or normally closed irrigation controllers

OPERATING SPECIFICATIONS

- Switch rating (24 VAC): 3 A
- Includes 7 m of 0.5 mm² sheathed, UL-approved wire
- Approvals: UL, cUL, FCC, CE, RCM
- Warranty period: 5 years

USER-INSTALLED OPTIONS

- Optional Gutter Mount (P/N SGM)



Mini-Click Sensor
(with mounting arm)
Height: 5 cm
Length: 15 cm
Width: 2.5 cm



Mini-Click Sensor
(with stainless steel enclosure)
Height: 13.9 cm
Length: 7.6 cm
Width: 10.1 cm

MINI-CLI TM	
Model	Description
MINI-CLI TM	Mini-Click Sensor
MINI-CLI TM -NO	Mini-Click Sensor, normally open switch
MINI-CLI TM -C	Mini-Click Sensor, conduit mount
SG-MC	Mini-Click Sensor in a stainless steel sensor enclosure

Compatible with:



Waterproof Wire Connector
Page 139

SOIL-CLIK™

Sensor: **Soil Moisture**

This sensor prevents water waste by measuring soil moisture and shutting off irrigation when a pre-set level is reached.

KEY BENEFITS

- View current soil moisture level and status at a glance
- One-touch override allows soil moisture bypass for special conditions
- Low-voltage outdoor enclosure powered by host controller
- Connect to Hunter sensor inputs, or use to interrupt common wires in virtually any 24 VAC irrigation system
- Use with Solar Sync™ Sensor for maximum water savings; [see page 153](#)

OPERATING SPECIFICATIONS

- Switch rating (24 VAC): 5 A
- Input power (24 VAC): 100 mA
- Normally closed dry-contact closure
- 2 m maximum distance from Soil-Clik module to controller
- 300 m maximum distance from Soil-Clik module to sensor probe for AC installations
- 30 m maximum distance for NODE-BT installations
- Sensor probe includes 80 cm of direct-burial wire
- Approvals: UL, cUL, FCC, CE, RCM
- Warranty period: 5 years

Soil-Clik Module

Height: 11.4 cm
Width: 8.9 cm
Length: 3.2 cm



Soil-Clik Probe

Height: 8.3 cm
Diameter: 2 cm

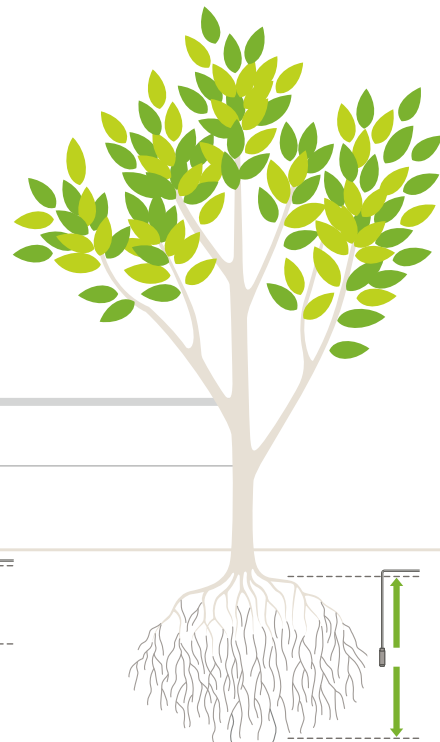

SOIL-CLIK

Model	Description
SOIL-CLIK	Soil-Clik moisture sensor module and probe
SC-PROBE	Soil moisture probe sensor for NODE-BT (module is not used)

Probe installed in root zone to monitor soil moisture

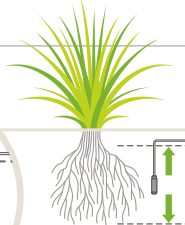
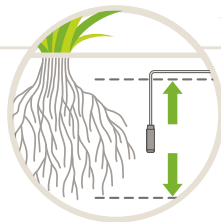
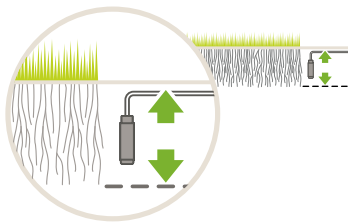

Compatible with:



Waterproof Wire Connector
Page 139



NODE-BT Controller
Page 130

In turf applications, the probe should be placed in the root zone, approximately 15 cm deep (adjust for actual turf conditions).

For shrubs or trees, select a deeper depth that matches the root zone. For new plantings, choose a spot halfway down the root ball, adjacent to native soil.

FREEZE-CLITM

Use this sensor to stop sprinklers from running during a freeze event and protect landscapes, walkways, and roadways from icy conditions.

KEY BENEFITS

- Automatically shuts off irrigation system when temperatures fall below 3°C
- Installs easily on automatic irrigation systems with no adjustments needed
- Use with other sensors to enhance overall efficiency of irrigation systems

Note: Not intended for agricultural applications

SPECIFICATIONS

- Switch rating (24 VAC): 5 A
- Includes 7 m of 0.5 mm² sheathed, two-conductor, UL-approved wire
- Approvals: UL, cUL, FCC, CE, RCM
- Warranty period: 5 years

FREEZE-CLI TM	
Model	Description
FREEZE-CLI TM	Wired freeze sensor

Sensor: **Freeze**



FREEZE-CLITM

Height: 5 cm
Length: 11 cm
Width: 3.5 cm

Compatible with:



Waterproof Wire Connector
Page 139

WIND-CLITM

This sensor keeps water coverage efficient and pedestrian paths and roadways safe by shutting down irrigation when wind speeds increase.

KEY BENEFITS

- Shuts off irrigation when winds are high
- Works well with fountains to eliminate overspray in windy conditions
- Installs easily on automatic irrigation systems with quick adjustments
- Compatible with most normally open or normally closed irrigation controllers

SPECIFICATIONS

- Switch rating (24 VAC): 5 A maximum
- Wind vane diameter: 13 cm
- Reset speed: 13 to 38 kph
- Mounts: Slip fits over 5 cm PVC pipe or attaches to 1 cm conduit with adapter (included)
- Approvals: UL, cUL, FCC, CE, RCM
- Warranty period: 5 years

WIND-CLI TM	
Model	Description
WIND-CLI TM	Wired wind sensor

Sensor: **Wind**



WIND-CLITM

Height: 10 cm
Wind vane diameter: 13 cm

Compatible with:



Waterproof Wire Connector
Page 139

MWS

This all-in-one wind, rain, and freeze sensor prevents water waste when any sensor triggers a stop to the system.

KEY BENEFITS

- Compact sensor with built-in wind, rain, and freeze sensors
- Installs easily on automatic irrigation systems with limited adjustment
- Set wind actuation speed shutdown from 13 to 38 kph
- Set system shutdown from 3 mm to 19 mm of rainfall
- Automatically shuts off system when temperatures fall below 3°C
- Mounts: Slip fits over 5 cm PVC pipe or attaches to 1 cm conduit with adapter (included)

OPERATING SPECIFICATIONS

- Switch rating (24 VAC): 5 A maximum
- Wind vane diameter: 13 cm
- Reset speed: 13 to 38 kph
- Approvals: UL, cUL, FCC, CE, RCM
- Warranty period: 5 years

Sensor: **Wind, Rain, Freeze**



MWS

Height: 20 cm
Wind vane diameter: 13 cm



MWS-FR

Height: 20 cm
Wind vane diameter: 13 cm

MWS

Model	Description
MWS	Weather station combines wind and rain sensors
MWS-FR	Weather station combines wind and rain sensors with a freeze sensor

Compatible with:



**Waterproof Wire
Connector**
Page 139

SOLAR SYNC™

Sensor: **ET, Rain, Freeze**

This sensor automatically adjusts controller run times daily based on local climate conditions to reduce water usage and improve plant health.

KEY BENEFITS

- Automatically adjusts irrigation run times based on weather conditions using on-site solar radiation and air temperature
- Quick Response™ Technology triggers instant rain shutoff
- Freeze sensing halts system operation at 3°C
- Wireless sensor kit simplifies installation
- Maintenance-free design with integrated battery for wireless models
- Adjustable vent ring allows for shorter or longer reset period
- Use with X-Core, Pro-C, ICC2, ACC2, and legacy ACC and I-Core™ Controllers
- Manage remotely with Centralus™ Software for ICC2 and ACC2 installations

OPERATING SPECIFICATIONS

- Solar Sync Technology:
 - Adjusts run times daily 3 minutes before midnight using the last 3 days of ET (evapotranspiration) data
- Quick Response Technology:
 - Time to turn off irrigation system: approximately 2 to 5 minutes for Quick Response
 - Time to reset Quick Response: approximately 4 hours under dry, sunny conditions
 - Time to reset when fully wet: approximately 3 days under dry, sunny conditions
- All models switch rating (24 VAC): 3 A
- Wired models include 7 m of 0.5 mm² sheathed, UL-approved wire
- Wireless model operating frequency: 433 MHz
- Wireless model range is 243 m line of sight from sensor to receiver
- Multiple wireless receivers can be operated from a single wireless sensor
- Approvals: UL, cUL, FCC, CE, RCM
- Warranty period: 5 years

USER-INSTALLED OPTIONS

- Vandal-resistant Wireless Sensor Guard for flat surfaces or pole mounting (order sensor separately)
- Vandal-resistant Wireless Receiver Guard for pedestal mounting (order receiver separately)

SOLAR SYNC	
Model	Description
SOLAR-SYNC-SEN	Wired Solar Sync Sensor and Gutter Mount
WSS-SEN	Wireless Solar Sync Sensor, Receiver, and Gutter Mount



Wired Solar Sync Sensor
(with mounting arm)
Height: 8 cm
Length: 22 cm
Width: 2 cm



Wireless Solar Sync Sensor
(with mounting arm)
Height: 11 cm
Length: 22 cm
Width: 2.5 cm



Wireless Solar Sync Receiver
(with wall-mounting kit)
Height: 14 cm
Length: 4 cm
Width: 4 cm



Wireless Sensor Guard
(with mounting hardware)
Height: 7 cm
Length: 9.5 cm
Width: 3.2 cm



Wireless Receiver Guard
(with mounting hardware)
Height: 12.7 cm
Length: 10.2 cm
Width: 3.2 cm

Compatible with:



Centralus Software
Page 122



Waterproof Wire Connector
Page 139



Smart WaterMark
Recognised as a responsible water-saving tool

FLOW-SYNC™

This cost-effective flow sensor is designed for use with commercial controllers.

Sensor: **Flow**

KEY BENEFITS

- Simple-insertion flow sensor for metering and reacting to real-time flow conditions
- Provides station-level flow monitoring for reaction to high- or low-flow conditions, helping to protect against flood damage and erosion
- Compatible with Hunter ACC2 and legacy ACC and I-Core™ Controllers, as well as ICD-SEN Sensor Decoders, for installation flexibility in a variety of settings
- Easy connection up to 300 m from controller or sensor decoder
- Sensor is pre-calibrated for K-factor and Offset based on pipe size, allowing for quick setup and programming within the controller

OPERATING SPECIFICATIONS

- Recommended pressure range: 1.5 to 15.0 bar; 150 to 1500 kPa
- Pressure loss: < 0.009 bar; 0.9 kPa
- Sensor wiring: 2 x direct burial, 0.75 mm² or greater, colour-coded or marked for polarity, up to 300 m from controller
- Warranty period: 5 years



Impeller-type flow meter, requires FCT fitting for pipe installation (order separately)

Compatible with:



**ACC2
Controllers**
Page 124

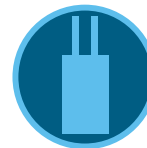

**ICD-SEN
Decoder**
Page 134



**Waterproof Wire
Connector**
Page 139

FLOW-SYNC

Model	Description
HFS	Hunter Flow-Sync Sensor for use with ACC2 and legacy ACC and I-Core Controllers; sensor requires FCT fitting for pipe installation

REQUIRED USER-INSTALLED OPTION (SPECIFY SEPARATELY)

Model	Description
FCT-100	1" (25 mm) Schedule 40 sensor receptacle tee
FCT-150	1½" (40 mm) Schedule 40 sensor receptacle tee
FCT-158	1½" (40 mm) Schedule 80 sensor receptacle tee
FCT-200	2" (50 mm) Schedule 40 sensor receptacle tee
FCT-208	2" (50 mm) Schedule 80 sensor receptacle tee
FCT-300	3" (80 mm) Schedule 40 sensor receptacle tee
FCT-308	3" (80 mm) Schedule 80 sensor receptacle tee
FCT-400	4" (100 mm) Schedule 40 sensor receptacle tee

BSP ADAPTERS FOR FCT FITTINGS

Diameter	Model
1" (25 mm)	795700
1½" (40 mm)	795800
2" (50 mm)	241400
3" (80 mm)	477800

FLOW RANGE

Pipe Diameter	Operating Range			
	Minimum		Suggested Maximum*	
	l/min	m ³ /hr	l/min	m ³ /hr
1" (25 mm)	7.6	0.45	64	3.84
1½" (40 mm)	19	1.14	132	8.0
2" (50 mm)	37.8	2.26	208	12.5
3" (80 mm)	106	6.36	450	27.0
4" (100 mm)	129	7.74	750	45.0

Notes:

* Good design practice dictates the maximum velocity not to exceed 1.5 m/sec. Suggested maximum velocity is based upon Class 200 IPS plastic pipe.

HC FLOW METER

Detect, monitor, and report critical flow zone data via wired or wireless connection with this robust and simple-to-install flow sensor.

KEY BENEFITS

- Compatible with Hydrawise® enabled HC, HPC, Pro-HC, and HCC Controllers
- Provides station-level flow rates and totals
- Sends automatic alerts in the event of high-flow, low-flow, or unscheduled flow conditions
- Flow reports within Hydrawise Software can display total system water use and individual station water use for accurate water budgeting and tracking
- Robust brass construction with union fittings for easy installation and removal for winterisation
- Analogue dial on the face of the meter displays daily flow totals and a leak detector

OPERATING SPECIFICATIONS

- Scaled pulse output is pre-calibrated based on the size of the meter
- When wired directly to the controller, the meter must be installed with shielded, minimum 0.75 mm² wire, up to 300 m from the controller
- Accuracy: ± 2% of reading at recommended flow
- HC Flow Meter pressure loss chart; [see page 258](#)
- Warranty period: 2 years

WIRELESS HC FLOW METER BENEFITS

- Add wireless communication to any HC Flow Meter (sensor sold separately)
- Send flow data wirelessly from the sensor to the controller, without the need to run wire or dig trenches

HC FLOW METER SPECIFICATIONS

	HC-075-FLOW-B (20 mm)	HC-100-FLOW-B (25 mm)	HC-150-FLOW-B (40 mm)	HC-200-FLOW-B (50 mm)
Minimum flow (l/min)	0.83	1.16	3.33	7.5
Maximum recommended flow (l/min)	60	110	250	400
Maximum flow rate (l/min)	80	130	330	500
Dial reading (m ³)	1 pulse per 1 litre	1 pulse per 10 litres	1 pulse per 10 litres	1 pulse per 10 litres

WIRELESS HC FLOW METER OPERATING SPECIFICATIONS

- 152 m range (line of sight) from transmitter to receiver
- Communication frequency: 868 MHz for international use; 915 MHz for use in Australia/New Zealand
- Transmitter power supply: 3 AA batteries
- Receiver power supply: 24 VAC from host controller
- Warranty period: 2 years

Sensor: **Flow**



HC-075-FLOW-B
(20 mm male BSP thread)
Height: 8 cm
Length: 23.2 cm
Depth: 8 cm
Weight: 0.9 kg

HC-150-FLOW-B
(40 mm male BSP thread)
Height: 16.2 cm
Length: 43.1 cm
Depth: 12.5 cm
Weight: 6.6 kg

HC-100-FLOW-B
(25 mm male BSP thread)
Height: 9.3 cm
Length: 26.2 cm
Depth: 8 cm
Weight: 1.4 kg

HC-200-FLOW-B
(50 mm male BSP thread)
Height: 16.2 cm
Length: 44.7 cm
Depth: 12.5 cm
Weight: 7.4 kg

WIRELESS HC FLOW METER



WIRELESS HC FLOW METER MODELS

Model	Description
W-HC-FLOW-INT	Wireless HC Flow Meter Kit, includes transmitter and receiver (international 868 MHz)
W-HC-FLOW-TR-INT	Wireless HC Flow Meter, transmitter only (international 868 MHz)
W-HC-FLOW-R-INT	Wireless HC Flow Meter, receiver only (international 868 MHz)
W-HC-FLOW-AU	Wireless HC Flow Meter Kit, includes transmitter and receiver (AU/NZ 915 MHz)
W-HC-FLOW-TR-AU	Wireless HC Flow Meter, transmitter only (AU/NZ 915 MHz)
W-HC-FLOW-R-AU	Wireless HC Flow Meter, receiver only (AU/NZ 915 MHz)
HC-075-FLOW-B	HC Flow Meter with 20 mm male BSP thread, m ³ reading
HC-100-FLOW-B	HC Flow Meter with 25 mm male BSP thread, m ³ reading
HC-150-FLOW-B	HC Flow Meter with 40 mm male BSP thread, m ³ reading
HC-200-FLOW-B	HC Flow Meter with 50 mm male BSP thread, m ³ reading

WFS

Use this sensor to retrofit flow to existing systems that cross under asphalt, concrete, or other hardscapes.

KEY BENEFITS

- Wireless flow sensor saves time, materials, and labour
- Simple-insertion flow sensor for monitoring and reacting to real-time flow conditions
- Provides station-level flow monitoring for reaction to high- or low-flow conditions, helping to protect against waste and damage from leaks
- Compatible with Hunter ACC2 and legacy ACC and I-Core™ Controllers for installation flexibility in a variety of settings
- Sensor is pre-calibrated for K-factor and Offset based on pipe size, allowing for quick setup and programming within the controller
- Multi-colour LED on the receiver indicates proper communication to the transmitter, as well as remaining battery life

OPERATING SPECIFICATIONS

- Recommended pressure range: 0 to 15.0 bar; 0 to 1500 kPa
- Pressure loss: < 0.009 bar; 0.9 kPa
- Maximum distance sensor to receiver: 152 m
- Operating frequency: 868 MHz
- FCC and CE approved
- Warranty period: 5 years

USER-INSTALLED OPTIONS

- FCT tee fittings for pipe installation

Sensor: **Flow**



WFS

Compatible with:



ACC2
Controllers
Page 124

WIRELESS FLOW SENSOR

Model	Description
WFS-INT	Wireless Flow Sensor Kit (international 868 MHz)
WFS-T-INT	Wireless Flow Sensor Kit transmitter only (international 868 MHz)
WFS-R-INT	Wireless Flow Sensor Kit receiver only (international 868 MHz)
WFS-ALKBATT	Wireless Flow Sensor alkaline battery with cage

FLOW RANGE

Wireless Flow Sensor Diameter	Operating Range			
	Minimum l/min	Minimum m ³ /hr	Suggested Max* l/min	Suggested Max* m ³ /hr
1" (25 mm)	7.6	0.45	64	3.84
1½" (40 mm)	19	1.14	132	8.0
2" (50 mm)	37.8	2.26	208	12.5
3" (80 mm)	106	6.36	450	27.0
4" (100 mm)	129	7.74	750	45.0

Notes:

* Good design practice dictates the maximum velocity not to exceed 1.5 m/sec. Suggested maximum velocity is based upon Class 200 IPS plastic pipe.

REQUIRED USER-INSTALLED OPTION (SPECIFY SEPARATELY)

Model	Description
FCT-100	1" (25 mm) Schedule 40 sensor (white) receptacle tee
FCT-150	1½" (40 mm) Schedule 40 sensor (white) receptacle tee
FCT-158	1½" (40 mm) Schedule 80 sensor (grey) receptacle tee
FCT-200	2" (50 mm) Schedule 40 sensor (white) receptacle tee
FCT-208	2" (50 mm) Schedule 80 sensor (grey) receptacle tee
FCT-300	3" (80 mm) Schedule 40 sensor (white) receptacle tee
FCT-308	3" (80 mm) Schedule 80 sensor (grey) receptacle tee
FCT-400	4" (100 mm) Schedule 40 sensor (white) receptacle tee



FLOW-CLITM

Sensor: **Flow**

Add high-flow shutoff capabilities to any irrigation controller with this simple, adjustable device.

KEY BENEFITS

- Automatically shuts down entire system if an overflow condition occurs, helping to protect against flood damage and erosion
- Single-button calibration to set highest flow rate
- User-adjustable timing and delay for sensor response
- Compatible with all Hunter AC-powered controllers for a variety of applications
- Multi-colour LED indicates system status and if flow is within limits

OPERATING SPECIFICATIONS

- Recommended pressure range: 1.5 to 15.0 bar; 150 to 1500 kPa
- Current draw (24 VAC): 0.025 A
- Switching current: 2 A maximum
- Sensor wiring: 2 x direct burial, 0.75 mm² or greater, colour-coded or marked for polarity, up to 300 m from the interface module
- Programmable start up delay: 0 to 300 seconds (allows for system hydraulics to stabilise and prevents false flow readings)
- Programmable interrupt period: 5 to 60 minutes (or option to reset manually)
- Warranty period: 5 years

USER-INSTALLED OPTIONS

- FCT fittings for 25 mm to 100 mm pipe diameters



Flow-Click Sensor and Module shown with required FCT fitting for pipe installation (sold separately)

Compatible with:



Waterproof Wire Connector
Page 139

SENSORS

FLOW-CLI TM	
Model	Description
FLOW-CLI TM	Standard kit for all 24 VAC controllers. <i>Includes sensor and interface module, sensor requires FCT for pipe installation.</i>
REQUIRED USER-INSTALLED OPTION (SPECIFY SEPARATELY)	
Model	Description
FCT-100	1" (25 mm) Schedule 40 sensor receptacle tee
FCT-150	1½" (40 mm) Schedule 40 sensor receptacle tee
FCT-158	1½" (40 mm) Schedule 80 sensor receptacle tee
FCT-200	2" (50 mm) Schedule 40 sensor receptacle tee
FCT-208	2" (50 mm) Schedule 80 sensor receptacle tee
FCT-300	3" (80 mm) Schedule 40 sensor receptacle tee
FCT-308	3" (80 mm) Schedule 80 sensor receptacle tee
FCT-400	4" (100 mm) Schedule 40 sensor receptacle tee

BSP ADAPTERS FOR FCT FITTINGS	
Diameter	Model
1" (25 mm)	795700
1½" (40 mm)	795800
2" (50 mm)	241400
3" (80 mm)	477800

FLOW RANGE				
Pipe Diameter	Operating Range			
	Minimum l/min	Minimum m ³ /hr	Suggested Maximum* l/min	Suggested Maximum* m ³ /hr
1" (25 mm)	7.6	0.45	64	3.84
1½" (40 mm)	19	1.14	132	8.0
2" (50 mm)	37.8	2.26	208	12.5
3" (80 mm)	106	6.36	450	27.0
4" (100 mm)	129	7.74	750	45.0

Notes:

* Good design practice dictates the maximum velocity not to exceed 1.5 m/sec. Suggested maximum velocity is based upon Class 200 IPS plastic pipe.



MICRO

MICRO

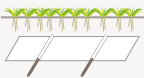
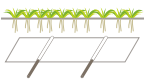

MICRO IRRIGATION SOLUTIONS

From ultra-durable Hunter Dripline to our innovative Root Zone Watering System, Hunter's micro irrigation solutions are designed to apply water efficiently and precisely where it's needed. Choose the combination of products best suited for your application and plant type using the chart below.

COMMON MICRO APPLICATIONS GUIDE		
APPLICATION	STANDARD DESIGN	ADVANCED DESIGN
TREES 	MLD, Emitters, Micro Sprays	HDL, PLD, Eco-Wrap, IH Risers, RZWS
MIXED PLANTINGS 	MLD, Micro Sprays, HDL, PLD, Single-Port Emitters	HDL-COP, Multi-Port Emitters, Eco-Wrap
SLOPED AREAS 	MLD, Micro Sprays, HDL-PC, HDL-R, Emitters, RZB	HDL-CV, Eco-Mat, Eco-Wrap, HDL-COP, IH Risers, RZWS
TURF 	HDL-COP	Eco-Wrap, Eco-Mat
SUBSURFACE 	HDL-COP	Eco-Wrap, Eco-Mat
SPARSE PLANTING 	Emitters, RZB	IH Risers
DENSE PLANTING 	Micro Sprays, HDL, PLD	HDL-COP, Eco-Wrap, Eco-Mat
GREEN ROOFS 	Eco-Mat	Eco-Mat
POTTED PLANTS 	Single-Port Emitters, Micro Sprays	MLD
RECLAIMED 	MLD, Micro Sprays, Emitters	HDL-R, IH Risers, RZWS

SOFT PIPE SYSTEMS

Using soft pipe to distribute irrigation water is acceptable in both commercial and residential applications. Polyethylene tubing is used in place of PVC and may be 1", ¾", or ½". Hunter offers a full suite of products that are compatible with soft pipe systems.

1 Tree and Shrub Rings:

- Convenient and efficient way to irrigate sparse plantings
- Use HDL or MLD to form the irrigation ring
- Connect with LOC Fittings for faster installation

2 6 mm PE Tubing:

- Use HDL-BLNK to distribute water
- Use 6 mm PE polyethylene (HQPE) or vinyl (HQV) to connect to emitters and micro sprays

3 Point-Source Emitters:

- Barbed emitters insert directly into PE tubing at the end of 6 mm vinyl/PE
- Colour-coded flows (2, 4, 8, 15, 23 l/hr)

4 Micro Spray Stakes:

- Use when higher flows are needed (0-114 l/hr)
- Throw water from 0-3.6 m

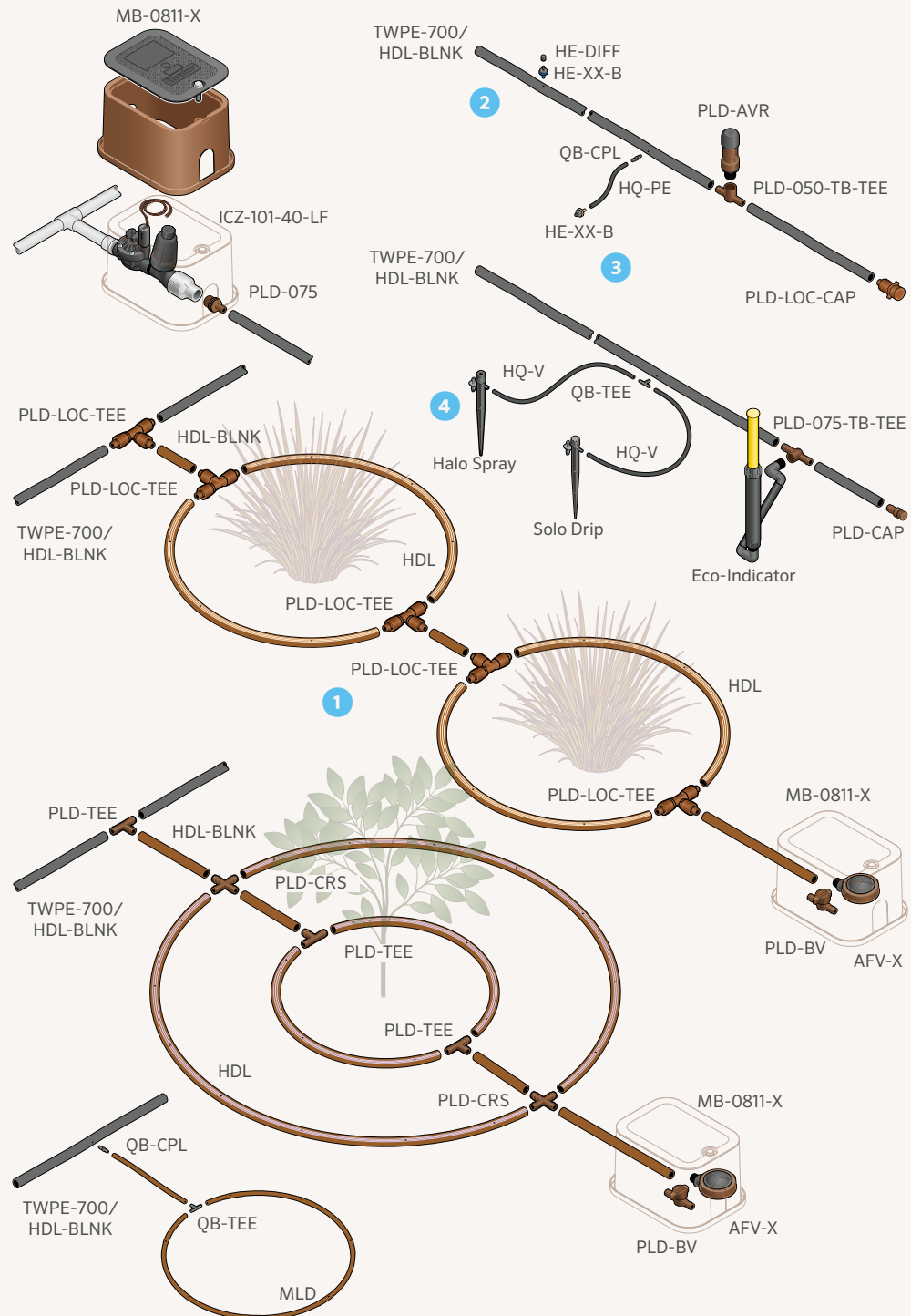

MICRO

HARD PIPE SYSTEMS

From multi-port emitters to micro sprays, Hunter offers a wide variety of products and accessories that are designed to complement hard pipe systems.

1 IH Risers:

- Ultra-durable point-to-point emitters
- Built-in check valve screen makes them great for slopes
- Wide variety of flows

2 Point-Source Emitters:

- Colour-coded flows (2, 4, 8, 23 l/hr)
- HEB (1/2" threaded emitter bubblers install directly onto 1/2" risers)
- HE-T (10-32 threaded emitters install onto rigid risers)

3 Multi-Port Emitters:

- Colour-coded flows (0-119 l/hr)
- Swivel barbs for directional flow
- Install directly onto 1/2" risers

4 Micro Sprays:

- Ideal for higher flows (0-114 l/hr)
- Diameter of throw (0-3.4 m)
- Install directly onto rigid risers or on 1/4" tubing

5 Root Zone Watering System:

- For deep root irrigating
- Allows oxygen to penetrate the soil
- Encourages healthier root growth

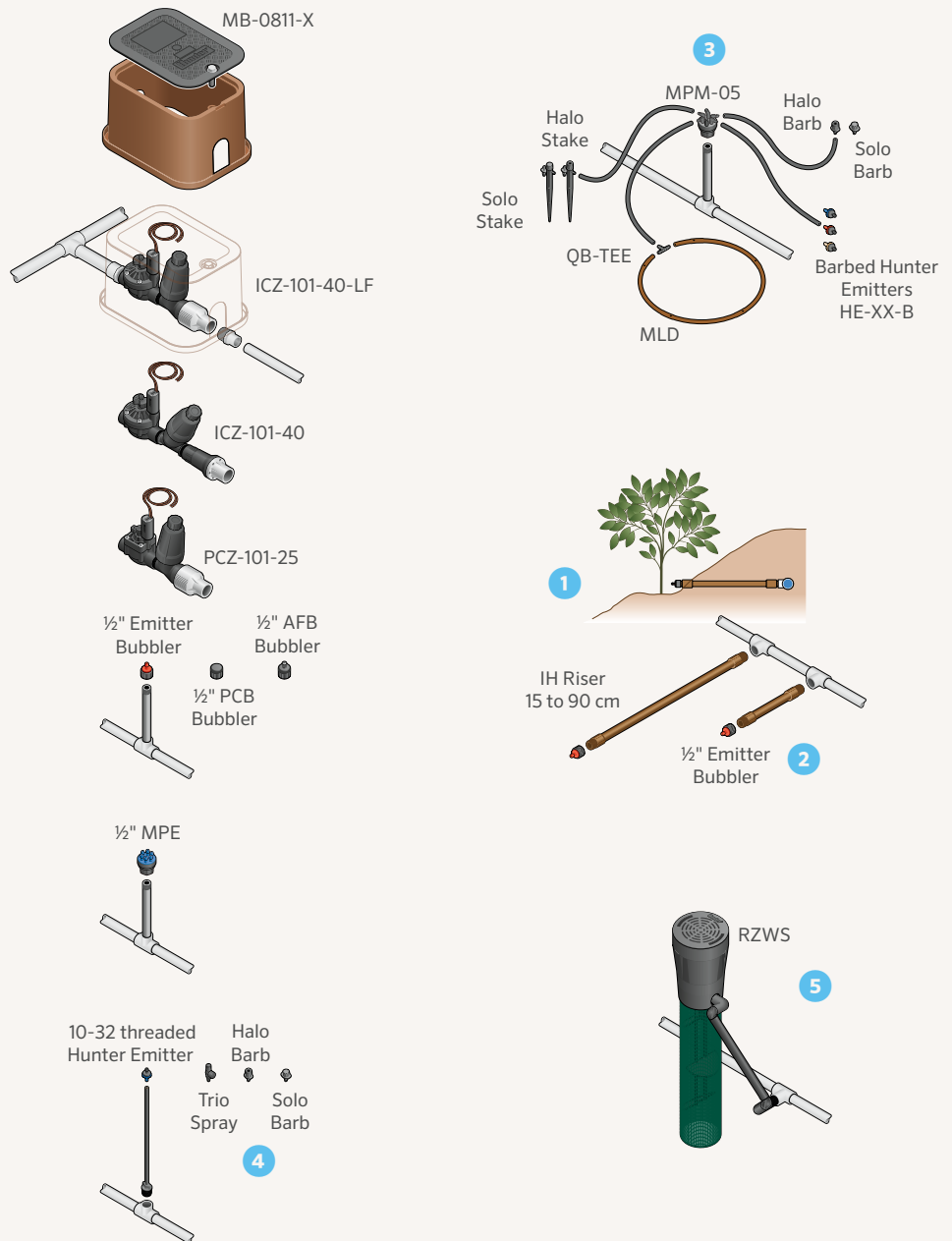

PCZ DRIP CONTROL ZONE KITS

Make installations quick and easy with this robust, preassembled kit with stainless steel filtration and pressure regulation.

KEY BENEFITS

- Factory-assembled for quick and easy installation
- Valves 100% water-tested to ensure dependable operation
- Senninger regulator provides precise regulation to protect system from high pressure
- 150 mesh (100 microns) stainless steel screen for years of reliable filtration

USER-INSTALLED OPTIONS

- Reclaimed water ID handle for PCZ-101 (P/N 269205)

OPERATING SPECIFICATIONS

- Pressure regulation: 1.7 or 2.8 bar; 170 or 280 kPa
- Flow: 2 to 55 l/min
- Operating pressure: 1.4 to 8.0 bar; 140 to 800 kPa
- Operating temperature: up to 66°C
- 150 mesh; 100 microns stainless steel screen

SOLENOID OPERATING SPECIFICATIONS

- Heavy-duty solenoid 24 VAC
 - 350 mA inrush current, 190 mA holding current, 60 Hz
 - 370 mA inrush current, 210 mA holding current, 50 Hz
- Warranty period: 2 years



PCZ-101

Height: 18 cm
 Width: 7 cm
 Length: 26 cm
 1" BSP (25 mm) inlet x 3/4" outlet

PCZ-101 Installed



DRIP CONTROL ZONE KITS	
Model	Description
PCZ-101-25-B	1" flow control PGV Valve with HFR; 1.7 bar; 170 kPa regulator, 3/4" outlet
PCZ-101-40-B	1" flow control PGV Valve with HFR; 2.8 bar; 280 kPa regulator, 3/4" outlet

PCZ CONTROL ZONE KITS: PRESSURE REQUIREMENTS BASED ON FLOW			
System Flow		PCZ-101-25-B (170 kPa outlet)	PCZ-101-40-B (280 kPa outlet)
I/min	m ³ /hr	Inlet pressure required to achieve desired outlet pressure (kPa)	
1.9	0.14	234	283
3.8	0.28	235	290
19.0	1.14	234	310
37.8	2.27	255	358
56.8	3.41	283	407

System Flow		PCZ-101-25-B (1.7 bar outlet)	PCZ-101-40-B (2.8 bar outlet)
I/min	m ³ /hr	Inlet pressure required to achieve desired outlet pressure (bar)	
1.9	0.14	2.3	2.8
3.8	0.28	2.3	2.9
19.0	1.14	2.3	3.1
37.8	2.27	2.6	3.6
56.8	3.41	2.8	4.1

MICRO

FILTERS & FILTER REGULATORS

Choose rugged filters and filter regulators with stainless steel screens for maximum performance.

KEY BENEFITS

- HFR-075 (Hunter Filter Regulator)
 - Compact, all-in-one filter and regulator minimise required valve box space
 - Senninger regulator provides precise regulation to protect system from high pressure
 - 150 mesh (100 microns) stainless steel screen for years of reliable filtration
 - Wide flow range covers most drip applications
- HY-075 (Hunter Y-Filter)
 - 150 mesh (100 microns) stainless steel screen for years of reliable filtration
 - Wide flow range covers most drip applications

OPERATING SPECIFICATIONS

- HFR-075
 - Pressure regulation: 1.7 or 2.8 bar; 170 or 280 kPa
 - Flow: 2 to 55 l/min
 - Operating pressure: 1.4 to 8.0 bar; 140 to 800 kPa
 - Operating temperature: up to 66°C
- HY-075
 - Flow: up to 75 l/min
 - Operating pressure: up to 8.0 bar; 800 kPa
 - Operating temperature: up to 66°C
- Warranty period: 2 years



HFR-075-25

HFR-075-40

Height: 18 cm
Width: 7 cm
Length: 16 cm
3/4" inlet x 3/4" outlet



HY-075

Height: 15 cm
Width: 7 cm
Length: 13 cm

HUNTER FILTERS

Model	Description
HFR-075-25	Filter regulator, 3/4" inlet/outlet, 1.7 bar; 170 kPa
HFR-075-40	Filter regulator, 3/4" inlet/outlet, 2.8 bar; 280 kPa
HY-075	3/4" filter with 3/4" inlet/outlet

PCZ-101 installed in a Multi-Purpose Box



SENNINGER™ PRESSURE REGULATORS

Choose the most consistent and reliable pressure regulators in the industry.

KEY BENEFITS

- Maintain consistent preset outlet pressure to prevent damage to system components
- 100% water-tested to ensure accuracy and dependable operation
- Install above or below ground for convenience of design
- Tamper-proof construction provides reliability and long life

OPERATING SPECIFICATIONS

- PRL (¾"):
 - Flow range: 2 to 30 l/min
 - Maximum inlet pressure*: 6.9 to 8.3 bar; 690 to 830 kPa
- PRLV (¾"):
 - Flow range: 2 to 68 l/min
 - Maximum inlet pressure: 8.6 bar; 860 kPa
- PRLG:
 - Flow range: 2 to 27 l/min
 - Maximum inlet pressure: 8.3 bar; 830 kPa
- Warranty period: 2 years

*Maximum recommended inlet pressure should not exceed 5.5 bar; 550 kPa above nominal model pressure



PRL - Pressure-Regulating Low-Flow

Width: 4.8 cm
Length: 11.4 cm
¾" FNPT inlet x ¾" FNPT outlet



PRLV - Pressure-Regulating Limit Valve Wide-Range Flow

Width: 6.4 cm
Length: 14.7 cm
¾" FNPT inlet x ¾" FNPT outlet



PRLG - Pressure-Regulating Low-Flow ¾" hose thread

Width: 4.8 cm
Length: 11.4 cm
¾" FNPT inlet x ¾" FNPT outlet

The pressure regulator will maintain the predetermined operating pressure provided that the inlet pressure is at least 0.35 bar; 35 kPa above the expected outlet pressure, but not exceeding the maximum operating pressure.

PRL (¾") USE FOR STANDARD LOW-FLOW IRRIGATION APPLICATIONS

Model	Outlet Pressure	Inlet	Outlet
PRL203F3F	1.38 bar; 138 kPa	¾" FNPT	¾" FNPT
PRL253F3F	1.72 bar; 172 kPa	¾" FNPT	¾" FNPT
PRL303F3F	2.07 bar; 207 kPa	¾" FNPT	¾" FNPT
PRL353F3F	2.41 bar; 241 kPa	¾" FNPT	¾" FNPT
PRL403F3F	2.76 bar; 276 kPa	¾" FNPT	¾" FNPT

PRLV (¾") LIMITS STATIC PRESSURE TO 0.7 TO 1.0 BAR (70 TO 100 KPA) ABOVE PRESSURE RATING WHEN INSTALLED PRIOR TO VALVE

Model	Outlet Pressure	Inlet	Outlet
PRLV20MF3F3FV	1.38 bar; 138 kPa	¾" FNPT	¾" FNPT
PRLV30MF3F3FV	2.07 bar; 207 kPa	¾" FNPT	¾" FNPT
PRLV40MF3F3FV	2.76 bar; 276 kPa	¾" FNPT	¾" FNPT

PRLG ¾" HOSE THREAD

Model	Outlet Pressure	Inlet	Outlet
PRLG203FH3MH	1.38 bar; 138 kPa	¾" FHT	¾" MHT
PRLG253FH3MH	1.72 bar; 172 kPa	¾" FHT	¾" MHT
PRLG303FH3MH	2.07 bar; 207 kPa	¾" FHT	¾" MHT
PRLG403FH3MH	2.76 bar; 276 kPa	¾" FHT	¾" MHT

Choose the most consistent and reliable pressure regulators in the industry.

KEY BENEFITS

- Each regulator maintains a constant preset outlet pressure based on its flow/inlet pressure
- 100% water-tested for accuracy at Senninger's facilities
- Very low hysteresis and friction loss helps maintain accurate regulation
- Can be installed above or below ground
- Patented tamper-proof design
- No external metal parts for excellent corrosion resistance

OPERATING SPECIFICATIONS

- PMR-MF (3/4"):
 - Flow range: 7.5 to 75.7 l/min
 - Maximum inlet pressure*: 6.9 to 9.0 bar; 690 to 900 kPa
- Warranty period: 2 years on materials, workmanship, and performance

*Maximum recommended inlet pressure should not exceed 5.5 bar; 550 kPa above nominal model pressure



PMR-MF - Pressure-Master Regulator

Medium-Flow

Width: 6.4 cm

Length: 14.0 cm

3/4" Female inlet x 3/4" female outlet

PMR-MF (3/4")			
Model	Pressure	Inlet	Outlet
PMR20MF3F3FV	1.38 bar; 138 kPa	3/4" NPT	3/4" NPT
PMR25MF3F3FV	1.72 bar; 172 kPa	3/4" NPT	3/4" NPT
PMR30MF3F3FV	2.07 bar; 207 kPa	3/4" NPT	3/4" NPT
PMR35MF3F3FV	2.41 bar; 241 kPa	3/4" NPT	3/4" NPT
PMR40MF3F3FV	2.76 bar; 276 kPa	3/4" NPT	3/4" NPT
PMR50MF3F3FV	3.45 bar; 345 kPa	3/4" NPT	3/4" NPT

The pressure regulator will maintain the predetermined operating pressure provided that the inlet pressure is at least 0.35 bar; 35 kPa above the expected outlet pressure, but not exceeding the maximum operating pressure.

DRIPLINE SYSTEMS

Ultra-durable Hunter Dripline solutions are easy to install and provide maximum longevity in the field. HDL and PLD work efficiently and effectively to use as little water as possible and keep plants thriving.

1 The dripline grid is a common installation practice either at grade or subsurface. Establishing consistent laterals in dense plantings provides a quick and simple approach to irrigating a planted area.

2 Arranging the dripline through a series of plants is an accepted and reliable method of irrigation. Ensure the dripline has emission points near or around each plant.

3 Multi-Purpose Box:

- 25 cm x 18 cm opening
- Five colour options for lids

4 Control Zone Kit:

- Factory-assembled for quick and easy installation
- Low-, medium-, and high-flow kits

5 PLD/HDL:

- All versions are pressure-compensating
- Check valve options available

6 Fittings:

- Double-barb holds fittings tight
- LOC Fittings can be reused

7 Air/Vacuum Relief Valve:

- Helps prevent water hammer and tubing collapse
- Use at high point(s) in zone

8 Eco-Indicator:

- Pops up at 0.85 bar; 85 kPa and shows system is running
- Reveals when system pressure drops too low

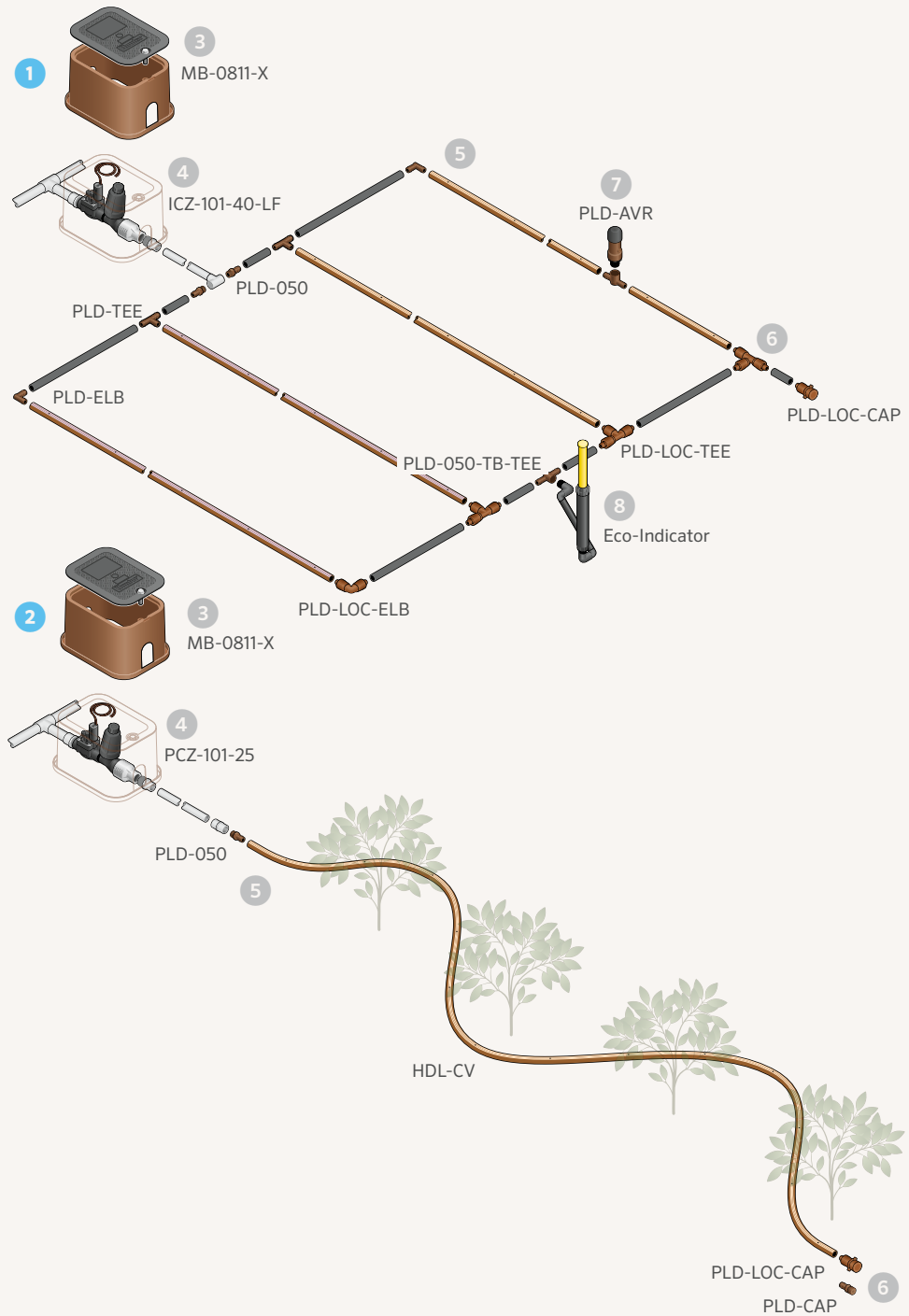

MICRO

HDL-CV

Increase drip system efficiency with pressure compensation, flow indication stripes, and a 1.8 m check height.

KEY BENEFITS

- Pressure-compensating emitters for consistent flow and uniform coverage
- Non-draining check valve (CV-ND) prevents low-point pooling and allows all emitters to open/close at the same time for greater system efficiency
- Check height of 1.8 m minimises system drainage and runoff
- Anti-siphon feature prevents debris from entering emitter at system shutdown
- Colour-coded stripes provide easy identification of flow
- UV resistance facilitates product longevity
- Stretch-wrapped coils stay intact and make installation quick and easy
- Superior grit tolerance provided by proprietary emitter design with multiple inlet filters, a wide turbulent labyrinth, and a full-size outlet pool

PRODUCT SPECIFICATIONS

- Available flow rates: 1.5, 2.1, 3.4 l/hr
- Available emitter spacing: 30 cm, 45 cm, 60 cm
- Tubing dimensions: 16.76 mm x 14.22 mm (outside/inside diameter)
- Available without emitter (HDL-BLNK)

OPERATING SPECIFICATIONS

- Operating range: 1 to 4.2 bar; 100 to 420 kPa
- Minimum filtration: 120 mesh (125 microns)
- Warranty period: 5 years



HDL-CV



Coil with Stretch Wrap



HUNTER DRIPLINE COLOUR CODE

- | | |
|----------------------|--|
| STRIPE COLOUR | TUBING COLOUR |
| ● 3.4 l/hr - Black | ● HDL-CV - Dark brown tubing, pressure-compensating with check valve |
| ● 2.1 l/hr - Grey | |
| ● 1.5 l/hr - Tan | |

HDL-CV - SPECIFICATION BUILDER: ORDER 1 + 2 + 3 + 4

1 Model	2 Spacing	3 Length	4 Options
HDL-04 = 1.5 l/hr flow	12" = 30 cm	100 = 30 m*	CV = Pressure-compensating with check valve
HDL-06 = 2.1 l/hr flow	18" = 45 cm	250 = 75 m	
HDL-09 = 3.4 l/hr flow	24" = 60 cm	500 = 150 m	
		1K = 300 m	

Example:

HDL-06-12-250-CV = 2.1 l/hr, 30 cm emitter spacing, 75 m coil with check valve

Note: *30 m coils available in the following HDL models only:

HDL-06-12-100-CV, HDL-09-12-100-CV

HDL-BLNK - SPECIFICATION BUILDER: ORDER 1 + 2 + 3

1 Model	2 Length	3 Options
HDL-BLNK = No emitters	100 = 30 m 250 = 75 m 500 = 150 m 1K = 300 m	(blank) = Brown R = Purple stripes

Examples:

HDL-BLNK-250 = No emitters, 150 m coil with purple stripes

HDL-BLNK-500-R = No emitters, 75 m coil

MAXIMUM RUN LENGTHS

HDL-CV - 1.5 l/hr				HDL-CV - 2.1 l/hr				HDL-CV - 3.4 l/hr			
Pressure (bar; kPa)	Emitter Spacing (cm)			Pressure (bar; kPa)	Emitter Spacing (cm)			Pressure (bar; kPa)	Emitter Spacing (cm)		
	30	45	60		30	45	60		30	45	60
1.0; 100	62	88	112	1.0; 100	52	73	93	1.0; 100	36	50	64
2.0; 200	116	163	207	2.0; 200	96	134	171	2.0; 200	66	94	119
3.0; 300	142	200	255	3.0; 300	117	166	210	3.0; 300	81	115	146
4.0; 400	161	228	289	4.0; 400	134	189	239	4.0; 400	92	131	165

HDL-PC & HDL-R

Maximise drip system longevity with robust material construction and pressure compensation for standard and reclaimed applications.

KEY BENEFITS

- Pressure-compensating emitters for consistent flow and uniform coverage
- Colour-coded stripes provide easy identification of flow
- UV resistance facilitates product longevity
- Stretch-wrapped coils stay intact and make installation quick and easy
- Superior grit tolerance provided by proprietary emitter design with multiple inlet filters, a wide turbulent labyrinth, and a full-size outlet pool
- Reclaimed product (HDL-R) identified by purple stripes assists in visual identification when using non-potable water

PRODUCT SPECIFICATIONS

- Available flow rates: 2.1, 3.4 l/hr
- Available emitter spacing: 30 cm, 45 cm, 60 cm
- Tubing dimensions: 16.76 mm x 14.22 mm (outside/inside diameter)
- Available without emitter (HDL-BLNK)

OPERATING SPECIFICATIONS

- Operating range: 1 to 4.2 bar; 100 to 420 kPa
- Minimum filtration: 120 mesh (125 microns)
- Warranty period: 5 years



HDL-PC



HDL-R (Reclaimed)

Optional colour for reclaimed water sources, available for 17 mm only.

HDL - SPECIFICATION BUILDER: ORDER 1 + 2 + 3 + 4

1 Model	2 Spacing	3 Length	4 Options
HDL-06 = 2.1 l/hr flow	12 = 30 cm	250 = 75 m	PC = Pressure-compensating
HDL-09 = 3.4 l/hr flow	18 = 45 cm 24 = 60 cm	500 = 150 m 1K = 300 m	R = Reclaimed (available in 2.1 and 3.4 l/hr models only)

Example:

HDL-09-12-1K-PC = 3.4 l/hr, 30 cm emitter spacing, 300 m coil with PC emitter

Note: Two HDL-PC products are available in 30 m coils: HDL-06-12-100-PC and HDL-09-12-100-PC



HUNTER DRIPLINE COLOUR CODE

STRIPE COLOUR

- 3.4 l/hr - Black
- 2.1 l/hr GPH - Grey
- Reclaimed - Purple

TUBING COLOUR

- HDL-PC - Light brown tubing, pressure-compensating
- HDL-R - Light brown with purple stripe, pressure-compensating, reclaimed

MAXIMUM RUN LENGTHS

HDL-PC/HDL-R - 1.5 l/hr				HDL-PC/HDL-R - 2.1 l/hr				HDL-PC/HDL-R - 3.4 l/hr			
Pressure (bar; kPa)	Emitter Spacing (cm)			Pressure (bar; kPa)	Emitter Spacing (cm)			Pressure (bar; kPa)	Emitter Spacing (cm)		
	30	45	60		30	45	60		30	45	60
1.0; 100	87	123	156	1.0; 100	72	101	129	1.0; 100	50	71	89
2.0; 200	125	177	224	2.0; 200	103	147	186	2.0; 200	72	101	128
3.0; 300	149	210	266	3.0; 300	123	174	220	3.0; 300	85	120	153
4.0; 400	167	235	299	4.0; 400	137	194	247	4.0; 400	96	134	171

HDL-COP

Minimise the risk of root intrusion by adding copper to industry-leading Hunter Dripline.

KEY BENEFITS

- Copper oxide in the emitter provides root intrusion resistance
- Copper will not leach into soil possibly creating an unhealthy plant environment
- Slow-draining check valve (CV) emitters prevent low-point pooling and add to system efficiency
- Pressure-compensating emitters provide consistent flow over the entire lateral length
- Anti-siphon feature prevents debris from entering emitter
- Colour-coded stripes provide easy identification of flow
- UV resistance facilitates product longevity
- Stretch-wrapped coils stay intact and make installation quick and easy
- Multiple inlet filters in the emitter and a wide turbulent labyrinth provide superior grit tolerance
- Full-sized emitter outlet pool and raised wall inhibit debris and roots from entering the emitter

PRODUCT SPECIFICATIONS

- Available flow rates: 2.1, 3.4 l/hr
- Available emitter spacing: 30 cm
- Tubing dimensions: 16.76 mm x 14.22 mm (outside/inside diameter)

OPERATING SPECIFICATIONS

- Operating range: 1.0 to 4.2 bar; 100 to 420 kPa
- Minimum filtration: 120 mesh (125 microns)
- Warranty period: 5 years (plus 2 additional years for environmental stress cracking)

AVAILABLE MODELS

- HDL-09-12-250-COP
- HDL-09-12-1K-COP
- HDL-06-12-250-COP
- HDL-06-12-1K-COP
- HDL-09-18-250-COP
- HDL-09-18-1K-COP
- HDL-06-18-250-COP
- HDL-06-18-1K-COP

MAXIMUM RUN LENGTHS

HDL-COP - 2.1l/hr		HDL-COP - 3.4 l/hr	
Pressure (bar)	Emitter Spacing (cm)	Pressure (bar)	Emitter Spacing (cm)
1.0	52	1.0	36
2.0	96	2.0	66
3.0	117	3.0	81
4.0	134	4.0	92



HDL-COP



Coil with Stretch Wrap

HDL-COP

HOW IT WORKS

Hunter Dripline is known for having an industry-leading emitter with a high level of grit tolerance, accurate flows, and very high burst ratings. This robust emitter is now provided with the added protection of copper, which has been scientifically proven to inhibit root growth. HDL-COP is designed with copper particles infused directly into the emitter. These benefits are long-lasting and provide an effective, nontoxic, and noncorrosive method for aiding in the prevention of root intrusion.

HOW TO IRRIGATE SUBSURFACE

Effective subsurface irrigation requires a different technique than overhead irrigation. Shorter cycles and more frequent watering will assist in maintaining proper soil moisture, oxygenation of the soil, and the prevention of root intrusion. For more information, visit hunter.info/hdlsubsurfacepdf.

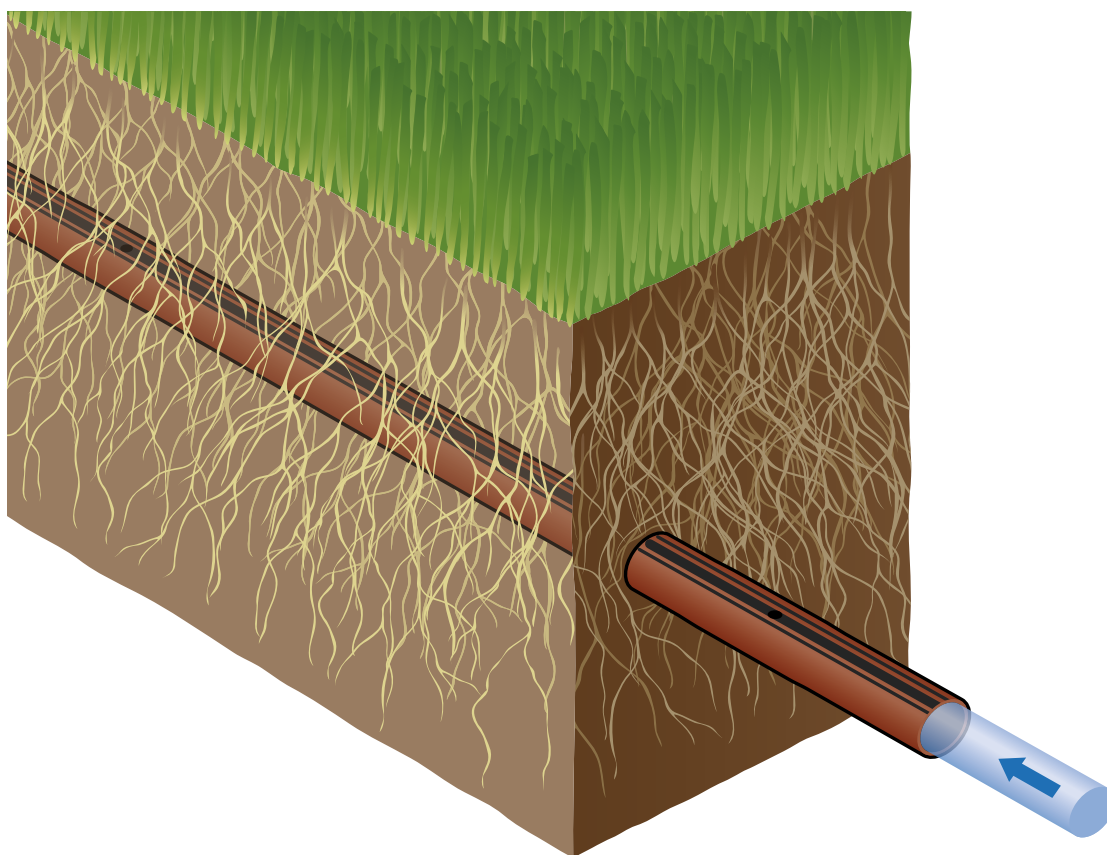

MICRO

PLD

High-quality, pressure-compensating emitters make PLD a great choice for most landscapes.

KEY BENEFITS

- Pressure-compensating emitters
- Flow rates of 2.2, 3.8 l/hr
- Emitter spacing at 30 cm and 50 cm
- Use with PLD-LOC or barbed PLD Fittings
- Strong UV resistance
- Check valves keep the line charged up to 1.5 m and prevent low-point drainage
- Anti-siphon prevents debris from entering emitters when used subsurface

OPERATING SPECIFICATIONS

- Pressure-compensating, non-draining emitters
- Operating pressure range: 1.0 to 3.5 bar; 100 to 350 kPa
- Minimum filtration: 120 mesh; 125 microns
- Warranty period: 5 years



PLD-CV

PLD Installed



MICRO

16 MM EMITTER FLOW RATE - 2.2 l/hr		
Row Spacing (m)	Emitter Spacing (m)	
	0.30	0.50
0.30	24	15
0.35	21	13
0.40	18	11
0.45	16	10
0.50	15	9
0.55	13	8
0.60	12	7

16 MM EMITTER FLOW RATE - 3.8 l/hr		
Row Spacing (m)	Emitter Spacing (m)	
	0.30	0.50
0.30	42	25
0.35	36	22
0.40	32	19
0.45	28	17
0.50	25	15
0.55	23	14
0.60	21	13

16 MM DRIPLINE MAX LENGTH - 2.2 l/hr		
Pressure (bar; kPa)	Emitter Spacing (m)	
	0.30	0.50
1.0; 100	47	73
2.0; 200	84	131
3.0; 300	104	162

16 MM DRIPLINE MAX LENGTH - 3.8 l/hr		
Pressure (bar; kPa)	Emitter Spacing (m)	
	0.30	0.50
1.0; 100	35	54
2.0; 200	59	91
3.0; 300	72	112

16 MM QUICK REFERENCE CHART - l/min PER 100 M		
Emitter (l/hr)	Emitter Spacing (m)	
	0.30	0.50
1.5	12.2	7.3
3.8	21.1	12.7

Notes:
PLD is subject to order minimums.
Please contact your distributor for more information.

PLD 16 MM - SPECIFICATION BUILDER:

ORDER 1 + 2 + 3

1	Model	2	Spacing	3	Length	
	PLD-22 = 2.2 l/hr flow	30 cm	100 = 100 m	CV = Pressure-compensating, check valve		
	PLD-38 = 3.8 l/hr flow	50 cm	200 = 200 m			
			400 = 400 m			

Examples:

- PLD-22-30-100-CV = 2.2 l/hr dripline with 30 cm spacing in a 100 m roll
- PLD-22-50-200-CV = 2.2 l/hr dripline with 50 cm spacing in a 200 m roll
- PLD-38-50-400-CV = 3.8 l/hr dripline with 50 cm spacing in a 400 m roll

16 MM FITTINGS

Ensure a superior hold with robust acetal construction.

KEY BENEFITS

- Acetal material provides a secure connection
- Dual barb removes the need for clamps

PRODUCT SPECIFICATIONS

- Use with PLD or other 16 mm dripline

OPERATING SPECIFICATIONS

- Pressure range: up to 7 bar; 700 kPa
- Warranty period: 1 year



PLD-CPL-16
16 mm barb x barb



PLD-050-16
1/2" (12 mm) MPT x 16 mm barb



PLD-ELB-16
16 mm barb x barb elbow



PLD-TEE-16
16 mm barb x barb tee



PLD-BV-16
16 mm barb x barb ball valve

PLD INSERT BARBS- 16 MM

Model	Description
PLD-CPL-16	16 mm barb x barb
PLD-050-16	1/2" MPT x 16 mm barb
PLD-ELB-16	16 mm barb x barb elbow
PLD-TEE-16	16 mm barb x barb tee
PLD-BV-16	16 mm barb x barb ball valve

LOC FITTINGS

LOC Fittings are compatible with any nominal 1/2" tubing and dripline for quicker installs and easier repairs.

KEY BENEFITS

- Glass-filled polypropylene for added durability
- Thread lock connection method provides a secure connection while still allowing flexibility for service and system changes

PRODUCT SPECIFICATIONS

- Use with PLD, HDL, or other 16–18 mm dripline
- Install with PLD-IAC/PLD-IAE grommet and a 17.5 mm spade drill bit

OPERATING SPECIFICATIONS

- Operating pressure range: up to 10 bar; 1,000 kPa
- Warranty period: 2 years



PLD-LOC 075
3/4" male pipe thread x LOC



PLD-LOC 050
1/2" male pipe thread x LOC



PLD-LOC CAP
End cap x LOC



PLD-LOC ELB
Locking elbow



PLD-LOC CPL
Locking coupler



PLD-LOC FHS
3/4" female hose swivel x LOC



PLD-LOC TEE
Locking tee

17 MM BARB FITTINGS

Acetal construction holds vinyl and PE tubing for an ideal low-cost choice when installing dripline.

KEY BENEFITS

- Acetal material provides a secure connection
- Dual barb removes the need for clamps

PRODUCT SPECIFICATIONS

- Use with HDL or other 17 mm dripline
- Install with PLD-IAC/PLD-IAE grommet and a 17.5 mm spade drill bit

OPERATING SPECIFICATIONS

- Operating pressure range: up to 7 bar; 700 kPa
- Warranty period: 1 year



PLD-050
1/2" MPT x 17 mm barb



PLD-ELB
17 mm barb elbow



PLD-075
3/4" MPT x 17 mm barb



PLD-CPL
17 mm barb coupling



PLD-CAP
17 mm barb x 1/2" MPT with cap



PLD-075-TB-TEE
17 mm barb tee x 3/4" thread



PLD-BV
17 mm barb shut-off valve



PLD-TEE
17 mm barb tee



PLD-075-TB-ELB
3/4" FPT x 17 mm barb elbow



PLD-050-TB-TEE
1/2" FPT x 17 mm barb tee



PLD-IAC
(with grommet)
Insert adapter x 17 mm coupling



PLD-IAE
(with grommet)
Insert adapter x 17 mm elbow



PLD-CRS
17mm barb cross

SUBSURFACE SYSTEMS

Subsurface drip irrigation systems can be extremely effective at saving water and encouraging root growth. Hunter is the only manufacturer to offer three tiers of top-quality subsurface irrigation solutions: HDL-COP Dripline, the Eco-Wrap System, and the Eco-Mat System.

1 Eco-Mat offers 30% greater efficiency than any other bare subsurface dripline product. It installs under the soil like a blanket of water, ready for the roots to absorb what they need.

2 Eco-Wrap provides resistance to root intrusion while enhancing the capillary action and efficiency of the system. Eco-Wrap combines the quality of HDL with the wicking properties of polyethylene fleece.

3 Entry Manifold:

- PVC (for stability) or polyethylene
- Assemble with either 17 mm or LOC Fittings

4 Multi-Purpose Box:

- 25 cm x 18 cm opening
- Five colour options for lids

5 Control Zone Kit:

- Factory-assembled for quick and easy installation
- Low-, medium-, and high-flow kits

6 Air/Vacuum Relief Valve:

- Helps prevent water hammer and tubing collapse
- Use at high point(s) in zone

7 Eco-Indicator:

- Pops up at 0.85 bar; 85 kPa and shows system is running
- Reveals when system pressure drops too low

8 Fittings:

- Double-barb holds fittings tight
- LOC Fittings can be reused

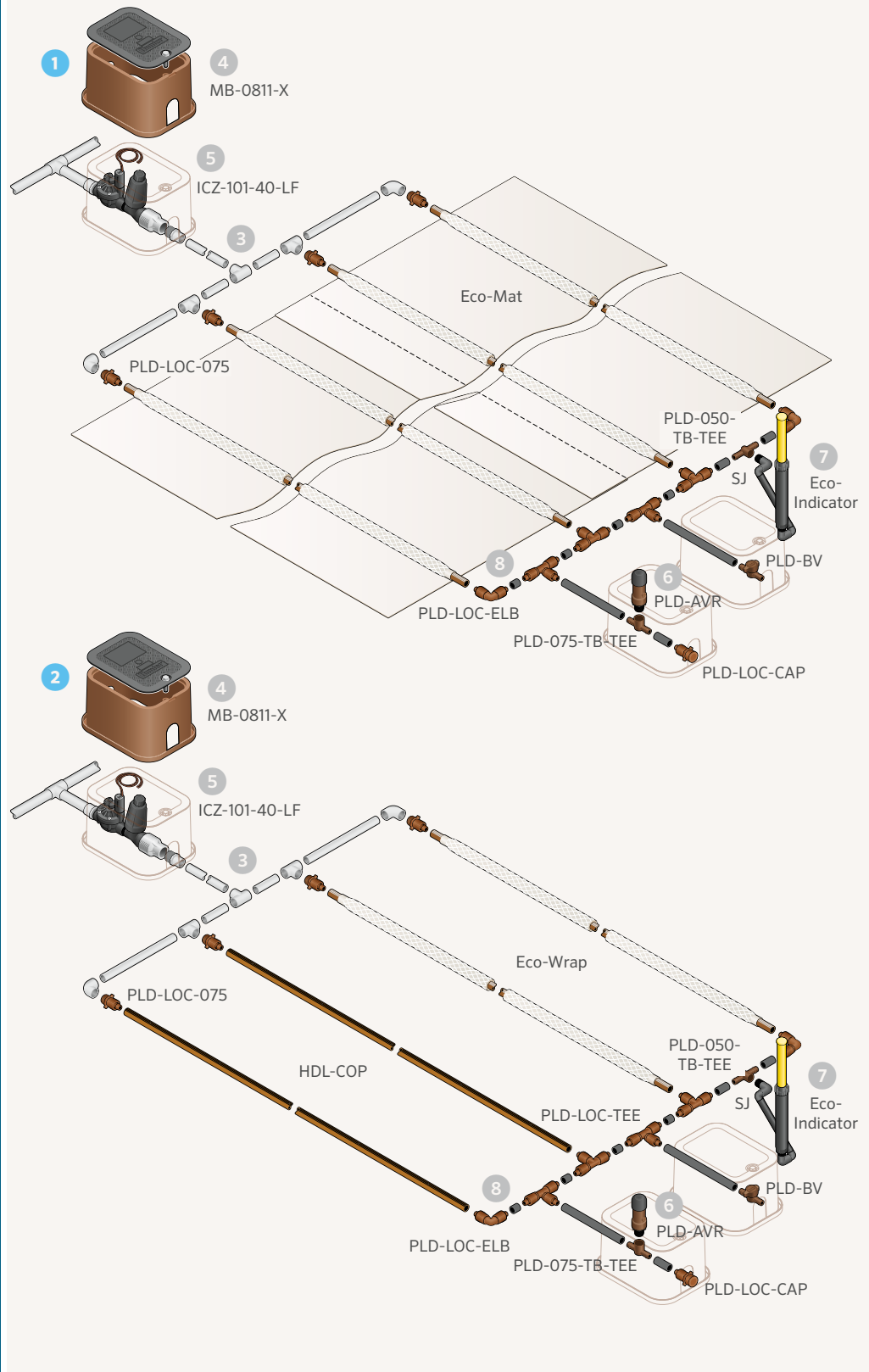

ECO-MAT™

Irrigate plants below the root zone for maximum efficiency with a combination of fleece-wrapped dripline and fleece blanket.

KEY BENEFITS

- Anti-siphon feature and fleece wrap protect against debris and root intrusion
- Saves 20–40% more water than standard products due to superior capillary movement of water to the entire root zone, promoting healthier root growth
- Non-draining, pressure-compensating emitters open/close simultaneously, maximising efficiency
- Check height of 1.5 m minimises system drainage and runoff

PRODUCT SPECIFICATIONS

- Flow rate: 2.2 l/hr; 0.13 m³/hr
- Emitter spacing: 30 cm
- Lateral row spacing: 35 cm
- Product width: 0.80 m
- Roll length: 16 mm = 100 m; 17 mm = 90 m
- Tubing dimensions: 0.660" x 0.560" (outside/inside diameter)
- Accepts 16/17 mm barb (depending on Eco-Mat selection) or LOC Fittings
- Water-holding capacity: 1.89 l/m³
- Approximate coverage per roll: 100 m roll = 75 m²; 90 m roll = 67 m²
- Example calculation based on area 12 m x 24 m:

$$\text{Roll Qty.} = \frac{\text{Irrigated landscape area}}{\text{Area of roll coverage}} = \frac{288 \text{ m}^2}{67 \text{ m}^2} = 4.3 \text{ (round up to 5 rolls)}$$

OPERATING SPECIFICATIONS

- Operating range: 1.0 to 3.5 bar; 100 to 350 kPa
- Minimum filtration: 120 mesh; 125 microns
- Air relief recommended for sloping conditions greater than 1.5 m
- Recommended installation depth: turf (10–15 cm); other (10–30 cm)
- May use in conjunction with the Eco-Wrap System
- Warranty period: 5 years

Eco-Mat Installed



ECO-MAT

Model	Description
ECO-MAT-16	PLD (16 mm) fleece drip mat, 100 m roll
ECO-MAT-17	HDL (17 mm) fleece drip mat, 90 m roll

Compatible with:

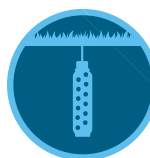

Soil-Clik
Page 150



Eco-Indicator
Page 177

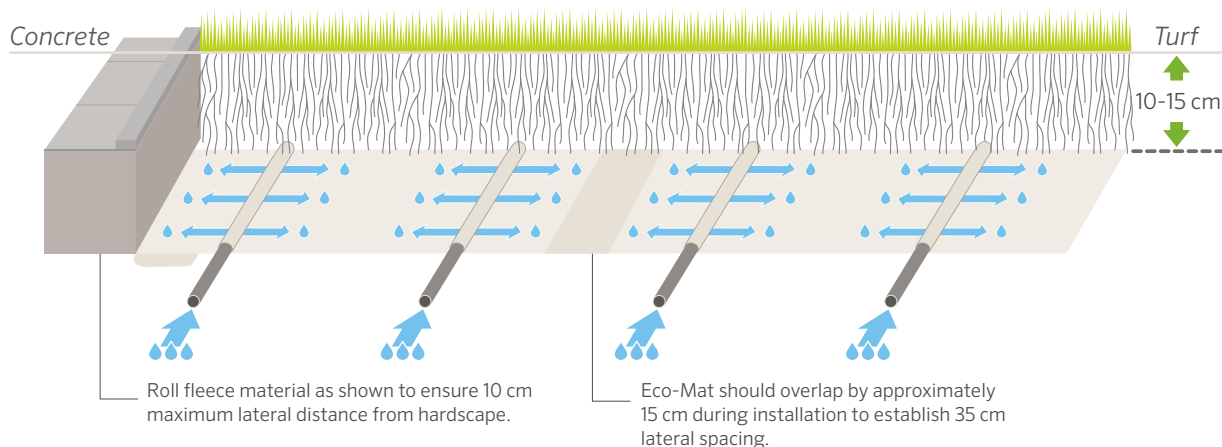

ECO-WRAP™

Irrigate more efficiently than blank dripline with fleece-wrapped dripline.

KEY BENEFITS

- Perfect for narrow areas that are difficult to irrigate with standard methods
- Anti-siphon feature and fleece wrap protect against debris and root intrusion
- Saves 20-40% more water than standard products due to superior capillary movement of water to the entire root zone, promoting healthier root growth
- Non-draining, pressure-compensating emitters open/close simultaneously, maximising efficiency
- Check height of 1.5 m minimises system drainage and runoff

PRODUCT SPECIFICATIONS

- Flow rate: 2.1 l/hr
- Emitter spacing: 30 cm
- Tubing dimensions: 0.660" x 0.560" (outside/inside diameter)
- Roll length: 16 mm = 100 m; 17 mm = 90 m
- Accepts 16 mm barb or LOC Fittings

OPERATING SPECIFICATIONS

- Operating range: 1.0 to 3.5 bar; 100 to 350 kPa
- Minimum filtration: 120 mesh; 125 microns
- Air relief recommended for sloping conditions greater than 1.5 m
- Recommended installation depth: turf (10-16 cm); other (10-30 cm)
- Compatible with the Eco-Mat System
- Warranty period: 5 years

MAXIMUM RUN LENGTH FOR ECO-MAT AND ECO-WRAP

Pressure (bar; kPa)	Length (m)
1.0; 100	52
1.5; 150	75
2.0; 200	95
2.5; 250	106
3.5; 350	126
4.0; 400	130



Eco-Wrap

ECO-WRAP

Model	Description
ECO-WRAP-16	PLD (16 mm) fleece drip wrap, 100 m roll
ECO-WRAP-17	HDL (17 mm) fleece drip wrap, 75 m roll

Eco-Wrap Installed



Compatible with:

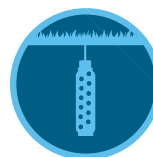

Soil-Clik
Page 150



Eco-Indicator
Page 177

SUPPLY TUBING

UV-resistant polyethylene makes this 0.700" x 0.600" solution a useful addition to drip systems.

KEY BENEFITS

- Thick wall and UV resistance provide durability and longevity
- Kink resistance for added flexibility and quicker installation

PRODUCT SPECIFICATIONS

- 17.8 mm x 15.2 mm (outside x inside diameter)

OPERATING SPECIFICATIONS

- 0 to 4.1 bar; 0 to 410 kPa
- Warranty period: 2 years



17 mm PE Tubing

SUPPLY TUBING (THICK-WALLED POLYETHYLENE)

Model	Description
TWPE-700-100	½" PE tubing - 30 m
TWPE-700-250	½" PE tubing - 75 m
TWPE-700-500	½" PE tubing - 150 m
TWPE-700-1K	½" PE tubing - 300 m

Example:

TWPE-700-250 = 17 mm polyethylene tubing in a 76 m roll

ECO-INDICATOR

Confirm system operation and adequate pressure with this handy visual tool.

KEY BENEFITS

- Visible yellow stem indicates when system is in operation
- Stem pops up when pressure exceeds 0.85 bar; 85 kPa and assists in confirming low pressures if not raised

OPERATING SPECIFICATIONS

- Operating pressure: up to 5.5 bar; 550 kPa
- Indication of system operation: above 0.85 bar; 85 kPa
- Warranty period: 2 years

Eco-Indicator Installed



ECO-ID

Pair with subsurface Eco-Mat™ and Eco-Wrap™ Systems.

MLD

Use this 6 mm dripline solution for tight spaces and raised planters.

KEY BENEFITS

- Superior flexibility makes MLD an excellent choice for small spaces and raised containers
- Properly irrigates without being intrusive to the landscape

PRODUCT SPECIFICATIONS

- Colours: brown or black polyethylene
- Emitter spacing: 15 cm or 30 cm
- Coil sizes: 30 m or 75 m
- 6.4 mm x 4.5 mm (outside/inside diameters)
- Use with 6 mm barb fittings

OPERATING SPECIFICATIONS

- Pressure range: 0.7 to 2.8 bar; 70 to 280 kPa
- Minimum filtration: 150 mesh; 120 microns
- Maximum run lengths: 15 cm = 4.6 m; 30 cm = 9.2 m
- Warranty period: 2 years



MLD

MLD Installed

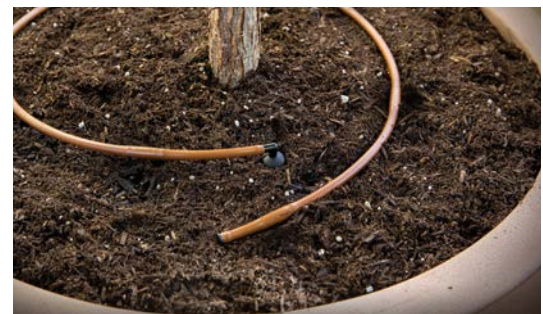

MLD - SPECIFICATION BUILDER: ORDER 1 + 2 + 3 + 4

1 Model	2 Spacing	3 Length	4 Options
MLD-05	06 = 15 cm 12 = 30 cm	100 = 30 m 250 = 75 m	BL = Black (blank) = Brown

Example: MLD-05 - 12 - 250 = 1.9 l/hr mini dripline with 30 cm spacing in a 76 m roll, brown

MLD FLOW CHART

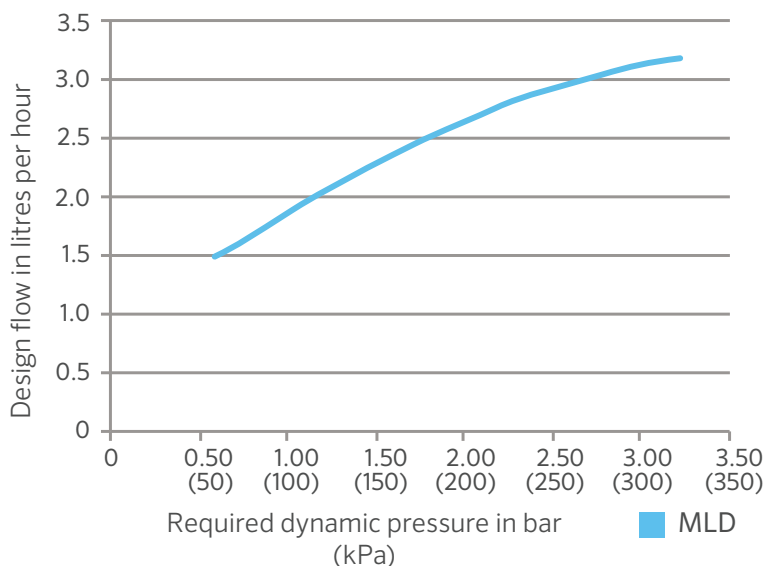

DISTRIBUTION TUBING

Add stability and flexibility when using point-source emitters or micro sprays.

KEY BENEFITS

- High-quality vinyl or polyethylene securely connects to acetal (6 mm) fittings
- Vinyl is more flexible, but it softens in high heat and should be used in cooler climates
- Polyethylene performs well in warmer climates

PRODUCT SPECIFICATIONS

- Material: polyethylene or vinyl
- Coil sizes: 30 m, 75 m, and 300 m

OPERATING SPECIFICATIONS

- Operating pressure range: up to 4.1 bar; 410 kPa
- Warranty period: 2 years



6 mm Tubing

6 MM TUBING – SPECIFICATION BUILDER: ORDER 1 + 2 + 3

1 Model	2 Tubing Diameter	3 Length
HQPE = Polyethylene tubing	250 = 6 mm barb	100 = 30 m
HQV = Vinyl tubing		250 = 75 m
		1K = 300 m

Example:

HQPE-250-1K = 6 mm polyethylene tubing in a 300 m roll

6 MM FITTINGS

Ensure a superior hold with robust acetal construction.

KEY BENEFITS

- Acetal material provides a secure connection
- Goof plug lays flat to help prevent leaking

PRODUCT SPECIFICATIONS

- Fits Hunter MLD and distribution tubings

OPERATING SPECIFICATIONS

- Pressure range: up to 4 bar; 400 kPa
- Warranty period: 2 years



QB-TEE
6 mm barb tee



QB-ELB
6 mm barb elbow



QB-CPL
6 mm barb coupling



QB-CRS
6 mm barb cross



GP-025
Goof plug

6 mm Barb Fittings

Use with MLD or any vinyl or polyethylene 6 mm tubing, UV-stabilised materials, and durable single barb connection.

IH RISERS

Simplify point-to-point irrigation with vandal-resistant, heavy-duty IH Risers.

KEY BENEFITS

- Heavy-duty, military-grade, vandal-resistant design
- Made of flexible PVC for durability
- Brown components blend in with landscape
- Accepts any ½" FPT emitter
- Ideal for slopes
- At-grade or below-grade installation
- Pre-assembled with ½" MPT adapter and specified emitter with check valve
- Available as components for custom assemblies
- Check valve holds back 3.6 m of head

OPERATING SPECIFICATIONS

- Maximum flow: 26.5 l/min
- Maximum pressure: 4.1 bar; 410 kPa
- Warranty period: 2 years

IH Risers with Emitters - SPECIFICATION BUILDER: ORDER 1 + 2 + 3

1 Riser Length	2 Emitter Flow with Check Valve Screen	3 Fitting Options
IH-06 = 15 cm riser	05-CV = 2 l/hr	(blank) = Brown R = Reclaimed (purple fitting)
IH-12 = 30 cm riser	10-CV = 4 l/hr	
IH-18 = 45 cm riser	20-CV = 8 l/hr	
IH-24 = 60 cm riser	40-CV = 15 l/hr	
IH-36 = 90 cm riser	60-CV = 23 l/hr	

Example:

IH-12-10-CV = 30 cm irrigation hose riser with 4 l/hr emitter with brown fittings

Preassembled IH Risers with Emitters are built to order. Please check with your distributor and/or Hunter Customer Service for lead times.

IH RISER COMPONENTS SOLD SEPARATELY

Model	Description
SCREEN-CV	Filter screen with 2.7 m check valve
IH-FIT-3850	¾" x ½" MPT IH fitting
IH-FIT-3850-R	¾" x ½" MPT IH fitting (reclaimed)
IH-250	75 m length of irrigation hose
IPS-050-250	75 m length of ½" IPS



IH RISERS



FACTORY ASSEMBLED IH RISERS

Riser, filter screen, and emitter



SCREEN-CV

Filter screen with 3.6 m check valve



IH-FIT-3850,

IH-FIT-3850-R
¾" x ½" MPT IH fitting (reclaimed)



IPS-050-250

Flexible PVC for creating headers or custom risers



IH-250

POINT-SOURCE EMITTERS

Ensure accurate irrigation for mixed and sparse plantings with a wide range of flow rates.

KEY BENEFITS

- Pressure-compensating for consistent and reliable flow
- Colour-coded by flow for easy identification in the field
- Earth-tone colours blend in well with the surrounding environment
- Three inlet variations: 6 mm barb, 10-32 thread, ½" FPT
- Coined edges for easy grip
- Self-piercing barb
- Optional diffuser cap
- Self-flushing diaphragm

OPERATING SPECIFICATIONS

- Recommended pressure range: 1.4 to 3.5 bar; 140 to 350 kPa
- Minimum filtration: 150 mesh; 100 microns
- Warranty period: 2 years

½" FEMALE THREAD (BROWN BASE)

	Model	Inlet Type	Flow (l/hr)
● Blue	HEB-05-BR	½" female thread	2.0
● Red	HEB-20-BR	½" female thread	8.0
● Tan	HEB-40-BR	½" female thread	15.0
● Orange	HEB-60-BR	½" female thread	23.0



Pocket Punch
P/N POCKETPUNCH
(Punches, inserts, and removes emitters)



Hunter Emitter Multi-Tool
P/N HEMT
(Punches pilot holes and pellets, inserts and removes emitters, cuts tubing)

EMITTER MODEL CHART

	Model	Inlet Type	Flow (l/hr)
● Blue	HE-050-B	Self-piercing barb	2.0
● Black	HE-10-B	Self-piercing barb	4.0
● Red	HE-20-B	Self-piercing barb	8.0
● Tan	HE-40-B	Self-piercing barb	15.0
● Orange	HE-60-B	Self-piercing barb	23.0
● Blue	HE-050-T	10-32 thread	2.0
● Black	HE-10-T	10-32 thread	4.0
● Red	HE-20-T	10-32 thread	8.0
● Tan	HE-40-T	10-32 thread	15.0
● Orange	HE-60-T	10-32 thread	23.0
● Blue	HEB-05	½" female thread	2.0
● Black	HEB-10	½" female thread	4.0
● Red	HEB-20	½" female thread	8.0
● Tan	HEB-40	½" female thread	15.0
● Orange	HEB-60	½" female thread	23.0

DIFFUSER CAP

(HE-DIFF)
Gently diffuses water on higher flow emitters to prevent erosion.



½" FEMALE THREAD (brown base)



Inlet Options



① Self-piercing barb



② 10-32 thread



③ ½" female thread

MULTI-PORT EMITTERS

Use these emitters to irrigate groups of plants effectively from one source.

KEY BENEFITS

- Six pressure-compensating emitter ports provide consistent and reliable flow
- Colour-coded by flow for easy identification
- Earth-tone colours blend in with surrounding landscape
- Swivel elbows assist in placing water directly to plant
- MPM (Multi-Port Manifold) provides unrestricted flow for each outlet

PRODUCT SPECIFICATIONS

- Available in ½" FNPT
- Available flows: 2, 4, 8 l/hr
- PVC cap plugs port when not being used

OPERATING SPECIFICATIONS

- Pressure range: 1.4 to 3.5 bar; 140 to 350 kPa
- Minimum filtration: 150 mesh; 100 microns
- Warranty period: 2 years

MULTI-PORT EMITTER MODEL CHART

	Model	Flow (l/hr)
● Blue	MPE-05	2.0
● Black	MPE-10	4.0
● Red	MPE-20	8.0
● Grey	MPM-050	N/A



Multi-Port Emitter



Multi-Port Manifold
(MPM-050)

Unrestricted flow through outlets as indicated by grey colour. Use with 6 mm distribution tubing and a barbed emitter at the end (available in ½" FPT). Allows water to be directed to as many as six different locations.

Emitter Caps

(MPE-CAPS)
Plug unused 6 mm barbed emitter outlets. Use with Hunter Multi-Port Emitters.



RIGID RISERS

These risers maintain their stiffness even when used with micro sprays, making them a perfect choice for high-throw applications.

KEY BENEFITS

- Provide a rigid connection for emitters and micro sprays
- Increase the height of sprays for flower beds

PRODUCT SPECIFICATIONS

- Inlet configurations: blank, 6 mm barb, ½" FNPT

OPERATING SPECIFICATIONS

- Pressure range: 1.4 to 4.1 bar; 140 to 410 kPa
- Warranty period: 1 year



30 cm Rigid Riser

RIGID RISER MODEL CHART

Model	Description
RR12	30 cm rigid riser
RR12-T	30 cm rigid riser with ½" threaded base
RR12-B	30 cm rigid riser with 6 mm barb base

MICRO SPRAYS

Apply water accurately for small-area coverage.

SOLO-DRIP

- Eight streams of water for thorough coverage
- Adjustable cap for flow and radius adjustment



SOLO-DRIP PERFORMANCE DATA

Pressure (bar; kPa)	Flow (l/hr)	Throw Diameter (m)	
		360° x 18 Hole	Radius of Throw
1.0; 100	0-40	0-0.5	0-1.5
1.5; 150	0-50	0-0.6	0-2.1
2.0; 200	0-60	0-0.8	0-2.6

Note: Adjustable to maximum (approx. 20 clicks)

HALO-SPRAY

- Adjustable umbrella of water
- Adjustable cap for flow and radius adjustment



HALO-SPRAY PERFORMANCE DATA

Pressure (bar; kPa)	Flow (l/hr)	Throw Diameter (m)	
		360° x 18 Hole	Radius of Throw
1.0; 100	0-52	0-1.7	0-5.0
1.5; 150	0-65	0-2.8	0-5.8
2.0; 200	0-74	0-3.4	0-6.4

Note: Adjustable to maximum (approx. 14 clicks)

TRIO-SPRAY

- Full-, half-, and quarter-circle configurations
- Adjustable cap for flow and radius adjustment



TRIO-SPRAY PERFORMANCE DATA

Pressure (bar; kPa)	Flow (l/hr)	Spray Pattern (m)		
		Diameter in Throw 360° x 18 Hole	Radius of Throw 180°	Radius of Throw 90°
0.5; 50	0-54	0-5.0	0-2.0	0-1.5
1.0; 100	0-77	0-5.8	0-2.5	0-2.1
1.5; 150	0-94	0-6.4	0-2.9	0-2.6
2.0; 200	0-105	0-7.0	0-3.2	0-3.0
2.5; 250	0-119	0-7.5	0-3.5	0-3.3

PRODUCT SPECIFICATIONS

- Inlet configurations: 6 mm barb, 10-32 thread, 6 mm barb stake

OPERATING SPECIFICATIONS

- Pressure range: 0.5 to 2.5 bar; 50 to 250 kPa
- Minimum filtration: 100 mesh; 150 microns
- Warranty period: 1 year



SD-T



SD-B



SD-B-STK
Height: 15.2 cm



HS-T



HS-B



HS-B-STK
Height: 15.2 cm



TS-T-F



TS-T-H



TS-T-Q

B = Barbed, F = Full, H = Half, Q = Quarter, STK = Stake, T = Threaded



For a more robust overhead micro spray system, pair Short-Radius Micro Spray Nozzles with Pro-Spray Sprinkler Bodies:



Short-Radius
Micro Spray Nozzles

Page 81

MULTI-PURPOSE BOX

This sturdy box is just right size to provide protection and easy access to essential irrigation components.

KEY BENEFITS

- Small footprint in a sturdy, durable box
- Five colour offerings blend in with any environment
- Overlapping lid prevents debris from entering box
- Knock-out bolt hole
- UV-protected, non-slip lid
- Warranty period: 2 years

PRODUCT SPECIFICATIONS

- Fits small control zone kits and other assorted components
- Durable HDPE construction
- $\frac{3}{8}$ " bolt included with every box



Multi-Purpose Box

Top
Width: 19.0 cm
Length: 26.7 cm

Bottom
Width: 21.6 cm
Length: 29.2 cm
Height: 20 cm



MB-LID-B



MB-LID-G



MB-LID



MB-LID-R



MB-LID-T

MULTI-PURPOSE BOX	
Model	Description
MB-0811	Multi-Purpose Box with standard brown lid
MB-0811-G	Multi-Purpose Box with green lid
MB-0811-T	Multi-Purpose Box with tan lid
MB-0811-R	Multi-Purpose Box with purple lid
MB-0811-B	Multi-Purpose Box with black lid
MB-BOX	Multi-Purpose Box (box only)
MB-LID	Multi-Purpose Box (lid only), brown
MB-LID-G	Multi-Purpose Box (lid only), green
MB-LID-T	Multi-Purpose Box (lid only), tan
MB-LID-R	Multi-Purpose Box (lid only), purple
MB-LID-B	Multi-Purpose Box (lid only), black

Multi-Purpose Box Installed



AIR/VACUUM RELIEF VALVE

Prevent water hammer and system collapse by discharging air during startup and allowing air to enter during shutdown.

KEY BENEFITS

- Releases air pockets without premature closure
- Leak-free closure after release
- Helps prevent system collapse through vacuum relief

PRODUCT SPECIFICATIONS

- UV-protected and corrosion-resistant material

OPERATING SPECIFICATIONS

- Pressure range: up to 5.5 bar; 550 kPa
- Warranty period: 2 years



AVR-075
Height: 13 cm
Width: 5 cm
Inlet: 3/4" MPT



PLD-AVR
1/2" Air/Vacuum Relief Valve

Air/Vacuum Relief Valve Installed



AUTOMATIC FLUSH VALVE

Keep laterals clean by automatically flushing water, air, and debris at each system startup.

KEY BENEFITS

- Flushes debris automatically at every system startup
- Reversible diaphragm to coordinate with low or high flow
- Lateral placement provides better grit tolerance

PRODUCT SPECIFICATIONS

- Removable top for diaphragm maintenance

OPERATING SPECIFICATIONS

- Pressure range: up to 4.1 bar; 410 kPa
- Low-flow diaphragm side: 7.6 to 18.9 l/m
- High-flow diaphragm side: 18.9 to 45.4 l/m
- Warranty period: 1 year



AFV-B
Automatic Flush Valve with
17 mm barb connection



AFV-T
Automatic Flush Valve with
1/2" MPT connection

Automatic Flush Valve Installed



RZWS

Deliver water across all levels of the root zone for high-efficiency subsurface irrigation of trees and shrubs.

KEY BENEFITS

- Patented StrataRoot™ Baffles divert water to all levels of the root zone while adding strength to the unit
- Durable locking cap for vandal resistance
- Pressure-compensating bubbler for accurate water flow
- Built-in Hunter Swing Joint for direct installation to ½" PVC fitting
- Pre-assembled for fast installation

OPERATING SPECIFICATIONS

- Bubbler flow rates: 0.9 l/min or 1.9 l/min
- Recommended pressure range: 1.0 to 4.8 bar; 100 to 480 kPa
- Warranty period: 2 years

FACTORY-INSTALLED OPTIONS

- Hunter check valve (HCV)
- Locking reclaimed water purple cap

USER-INSTALLED OPTIONS

- Fabric sleeve to prevent soil intrusion in sandy areas for 45 cm and 90 cm models (P/N RZWS-SLEEVE)
- Replacement cap for 45 and 90 cm models (P/N 913300SP)
- Locking reclaimed purple cap for 45 and 90 cm models (P/N 913301SP)
- Reclaimed water purple cap for 25 cm model (P/N RZWS10-RCC)



RZWS-10

Diameter: 5.1 cm
Length: 25 cm

RZWS-18

Tube diameter: 7.6 cm
Cap diameter: 12 cm
Length: 45 cm

RZWS-36

Tube diameter: 7.6 cm
Cap diameter: 12 cm
Length: 90 cm

RZWS patented StrataRoot Baffles



Reclaimed models available
(Add **-R** to model number)

RZWS – SPECIFICATION BUILDER: Order 1 + 2 + 3

1 Model	2 Bubbler Flow Rate	3 Options
RZWS-10 = 25 cm Root Zone Watering System	25 = 0.9 l/min	(blank) = No option
RZWS-18 = 45 cm Root Zone Watering System	50 = 1.9 l/min	CV = Check valve
RZWS-36 = 90 cm Root Zone Watering System	(blank) = No bubbler or swing joint	R = Reclaimed cap
		CV-R = Check valve with reclaimed cap

Examples:

RZWS-18-25-CV = 45 cm Root Zone Watering System at 0.9 l/min, with check valve

RZWS-10-50-R = 25 cm Root Zone Watering System at 1.9 l/min, with reclaimed cap

RZWS-36-25-CV-R = 90 cm Root Zone Watering System at 0.9 l/min, with check valve and reclaimed cap

ADDITIONAL OPTION (SPECIFY SEPARATELY)

RZWS-SLEEVE = Field-installed sleeve made from filter fabric

RZWS-E

Cultivate stronger, deeper roots by delivering water and oxygen directly to the root zone of trees and shrubs.

KEY BENEFITS

- Top serviceable cap design
- Pressure-compensating bubbler for accurate water flow
- Built-in Hunter Swing Joint for direct installation to ½" PVC fitting
- Pre-assembled for fast installation

OPERATING SPECIFICATIONS

- Bubbler flow rates: 0.9 l/min or 1.9 l/min
- Recommended pressure range: 1.0 to 4.8 bar; 100 to 480 kPa
- Warranty period: 2 years

RZWS-E - SPECIFICATION BUILDER: Order 1 + 2

1 Model	2 Bubbler Flow Rate
RZWS-E-18 = 45 cm Root Zone Watering System	25 = 0.9 l/min
RZWS-E-36 = 90 cm Root Zone Watering System	50 = 1.9 l/min

Examples:

- RZWS-E-18-50** = 45 cm Root Zone Watering System, 1.9 l/min bubbler
- RZWS-E-36-25** = 90 cm Root Zone Watering System, 0.9 l/min bubbler



RZWS-E-18
Diameter: 7.6 cm
Length: 45 cm

RZWS-E-36
Diameter: 7.6 cm
Length: 90 cm

MICRO

RZB

This accessory for small trees and shrubs assists in delivering water to roots.

KEY BENEFITS

- Solid mesh tube with perforated top to complement overhead or drip irrigation systems
- Allows oxygen and natural precipitation to reach the root zone
- Easy installation that directs overhead and drip irrigation to the root zone
- Warranty period: 1 year



RZB
Diameter: 5 cm
Length: 23 cm



RECLAIMED

RECLAIMED



RECLAIMED

Hunter's Full Line of RECLAIMED WATER PRODUCTS

ROTORS



PGJ	PGP ULTRA	I-20	I-25	I-40	I-50
PGJ-00-R	PGP-00-CV-R	I-20-00-R	I-25-04-B-R	I-40-04-SS-B-R	I-50-06-SS-B-R
PGJ-04-R	PGP-00-CV-R-PRB	I-20-00-R-PRB	I-25-04-SS-B-R	I-40-04-SS-ON-B-R	I-50-06-SS-ON-B-R
PGJ-06-R	PGP-04-CV-R	I-20-04-R	I-25-06-B-R	I-40-06-SS-B-R	
PGJ-12-R	PGP-04-CV-R-PRB	I-20-04-SS-R	I-25-06-SS-B-R	I-40-06-SS-ON-B-R	
	PGP-06-CV-R	I-20-04-R-PRB			
	PGP-12-CV-R	I-20-04-SS-R-PRB			
		I-20-06-R			
		I-20-06-SS-R			
		I-20-06-R-PRB			
		I-20-06-SS-R-PRB			
		I-20-12-R			

Rotors Key

00 - Shrub
04 - 10 cm pop-up
06 - 15 cm pop-up

12 - 30 cm pop-up
CV - Check valve
SS - Stainless steel

ON - Opposing nozzles
PRB - Pressure-regulated
body

ARV - Adjustable arc
3RV - Full-circle
RB - Reclaimed BSP

ROTORS



I-80	I-90
I-80-04-SS-R-B	I-90-ARV-B
I-80-04-SS-ON-R-B	I-90-3RV-B

SPRAYS



PRO-SPRAY	PRO-SPRAY PRS30	PRO-SPRAY PRS40
PROS-00-R	PROS-00-PRS30-R	PROS-00-PRS40-R
PROS-04-CV-R	PROS-04-PRS30-CV-R	PROS-04-PRS40-CV-R
PROS-06-CV-R	PROS-06-PRS30-CV-R	PROS-06-PRS40-CV-R
PROS-12-CV-R	PROS-12-PRS30-CV-R	PROS-12-PRS40-CV-R
PROS-RC-CAP-SP (snap-on)	PROS-04-PRS30-CV-F-R	PROS-04-PRS40-CV-F-R
458520SP = ID cap (threaded)	PROS-06-PRS30-CV-F-R	PROS-06-PRS40-CV-F-R
	PROS-12-PRS30-CV-F-R	PROS-12-PRS40-CV-F-R
	458560 = ID cap	458562 = ID cap

Sprays Key

00 - Shrub
04 - 10 cm pop-up

06 - 15 cm pop-up
12 - 30 cm pop-up

CV - Check valve

BUBBLERS



BUBBLERS

- PCB-25-R
- PCB-50-R
- PCB-10-R
- PCB-20-R

Bubblers Key

25 - 0.9 l/min 10 - 3.8 l/min
 50 - 1.9 l/min 20 - 7.6 l/min

VALVES



ICV

- ICV-101G-FS-R
- ICV-151G-B-FS-R
- ICV-201G-B-FS-R
- ICV-301-FS-R
- 561205 = ICV-101-201 series ID handle
- 515005 = ICV-301 series ID handle

Valves Key

B - BSP threads
 FS - Filter Sentry™ Mechanism
 LRC - Locking rubber cover
 RC - Rubber cover
 AW - Acme key with anti-rotation wheels

* Note: IBV purple tags are user-installed options.



IBV

- IBV-101G-B-FS-R
- IBV-151G-B-FS-R
- IBV-201G-B-FS-R
- IBV-301G-B-FS-R



QUICK COUPLERS

- HQ-33-DLRC-R
- HQ-44-LRC-R
- HQ-44-LRC-AW-R
- HQ-5-LRC-R
- HHQ-5-LRC-BSP-R

Quick Couplers Key

LRC - Locking rubber cover
 RC - Rubber cover
 AW - Acme key with anti-rotation wheels

MICRO



IH RISERS

- IH-RISER-XX-R
- IH-XX-YY-CV-R
- IH-FIT-3850-R



RZWS

- | | |
|-----------------|----------------------------------|
| RZWS-10-R | RZWS-36-R |
| RZWS-10-25-R | RZWS-36-25-R |
| RZWS-10-50-R | RZWS-36-50-R |
| RZWS-10-25-CV-R | RZWS-36-25-CV-R |
| RZWS-10-50-CV-R | RZWS-36-50-CV-R |
| RZWS-18-R | 913301SP |
| RZWS-18-25-R | (purple cap for 45 cm and 90 cm) |
| RZWS-18-50-R | RZWS10-RCC |
| RZWS-18-25-CV-R | (purple cap for 25 cm) |
| RZWS-18-50-CV-R | |



HDL

- | | |
|-----------------|-----------------|
| HDL-06-12-250-R | HDL-09-12-1K-R |
| HDL-06-12-500-R | HDL-09-18-250-R |
| HDL-06-12-1K-R | HDL-09-18-500-R |
| HDL-06-18-250-R | HDL-09-18-1K-R |
| HDL-06-18-500-R | HDL-09-24-250-R |
| HDL-06-18-1K-R | HDL-09-24-250-R |
| HDL-06-24-250-R | HDL-09-24-1K-R |
| HDL-06-24-1K-R | HDL-BLNK-250-R |
| HDL-09-12-250-R | HDL-BLNK-500-R |
| HDL-09-12-500-R | HDL-BLNK-1K-R |



MULTI-PURPOSE BOX

- MB-0811-R
- MB-LID-R (lid only)

Micro Key

IH Risers

12 - 30 cm XX - Riser length (15, 30, 45, 61, 91) cm
 18 - 45 cm YY - Emitter flow (2, 4, 8, 15, 23) l/hr
 24 - 61 cm CV - Check valve (standard)

RZWS

10 - 25 cm 25 - 0.9 l/min
 18 - 45 cm 50 - 1.9 l/min
 36 - 90 cm CV - Check valve

HDL

BLNK - No emitter HDL-09 - 3.4 l/hr
 HDL-04 - 1.5 l/hr 12 - 12 cm
 HDL-06 - 2.1 l/hr 18 - 18 cm

24 - 24 cm 1K - 300 m
 250 - 75 m
 500 - 150 m



TOOLS

SPOTSHOT HOSE-END NOZZLE

MODELS

- ¾" hose thread inlet - P/N 160700
- 1" (25 mm) hose thread inlet - P/N 160705

KEY BENEFITS

- Variable nozzle stream choices:
 - Fan: Broad, light stream for turf hot spots
 - Soak: Medium stream for dust-control areas
 - Jet: Tight, focused stream for power washing

OPERATING SPECIFICATIONS

- Flow: 132 l/min; 8 m³/hr at 5.5 bar; 551 kPa*
- * Not recommended for residential use with regulated, low-pressure, or low-flow conditions



SpotShot Hose-End Nozzle
¾" P/N 160700SP
1" (25 mm) P/N 160705



Pitot Gauge
P/N 280100SP
Used to check operating pressure of rotor sprinklers



MP Gauge Assembly
P/N MPGAUGE
Used to check operating pressure on spray body sprinklers



Hand Pump
P/N 217500SP
Used to remove water from flooded areas during service and installation



Nozzle Insertion Collar
P/N 123200SP



Hunter Wrench
P/N 172000SP



T-Handle Tool
P/N 319100SP



Nozzle Removal/Installation Tool
P/N 803700
I-80, G-85B, G-885 short- and mid-range nozzles



Snap Ring Tool
P/N 251000SP
I-80 installation and removal

PILOT™ NETWORK



Pilot CCS

Powerful software designed with advanced tools to make irrigation simple and seamless



Pilot IHS

Reliable controllers with modern engineering and next-generation technology



TTS Rotors

Two-way modules with no-dig Total-Top-Serviceability



MAKE LIFE EASIER

WITH A NEW APPROACH TO GOLF IRRIGATION

Pilot CCS

Command Center Software

With next-generation Pilot software, you can create hydraulically safe and efficient daily course watering plans faster than ever before. Pilot helps manage thousands of individually controlled sprinklers in seconds. It's the ideal management tool for an Integrated Hub System.

Pilot IHS

Integrated Hub System

Integrated Hub Systems help you save time and money from day one. Compared to a Field Controller System, an Integrated Hub System uses less copper wire and requires fewer splices, valve boxes, and concrete pads. This means lower costs, faster installation, and easier system diagnosis and repair if needed. You can also easily expand the system if desired.

TTS Rotors

with Two-Way Modules

Two-way module (TWM) technology built into every TTS rotor permits highly efficient control of complex irrigation systems. The rotors are connected to the system via low-voltage, direct-burial communication cable.

ICD-HP PROGRAMMER

Communicate Directly with TWMs

Program and troubleshoot two-way modules with no digging or wires required. The handy device communicates directly through the plastic without barcodes, saving you time in the field.

PILOT™ COMMAND CENTER SOFTWARE

Enjoy simple yet powerful irrigation management and control with revolutionary Pilot CCS.

Pilot Command Center Software (CCS) is easy to use and has all the features you need to reliably and automatically water your course. Run times can be adjusted manually or determined automatically using ET. You create watering plans directly in the Command Center — a powerful irrigation planning tool that shows you every sprinkler on the course organised according to your management style.

PILOT SPECIFICATIONS

- Operating system: 64-bit Windows®
- Maximum controllers or hubs: about 1,000
- Maximum two-way module stations: about 1 million
- Sprinkler run time options: minutes, millimetres, inches, or ET
- Hydraulic management: fully customisable down to individual stations
- Mapping: interactive and based on scalable vector graphics (SVG)

Pilot Command Center Software

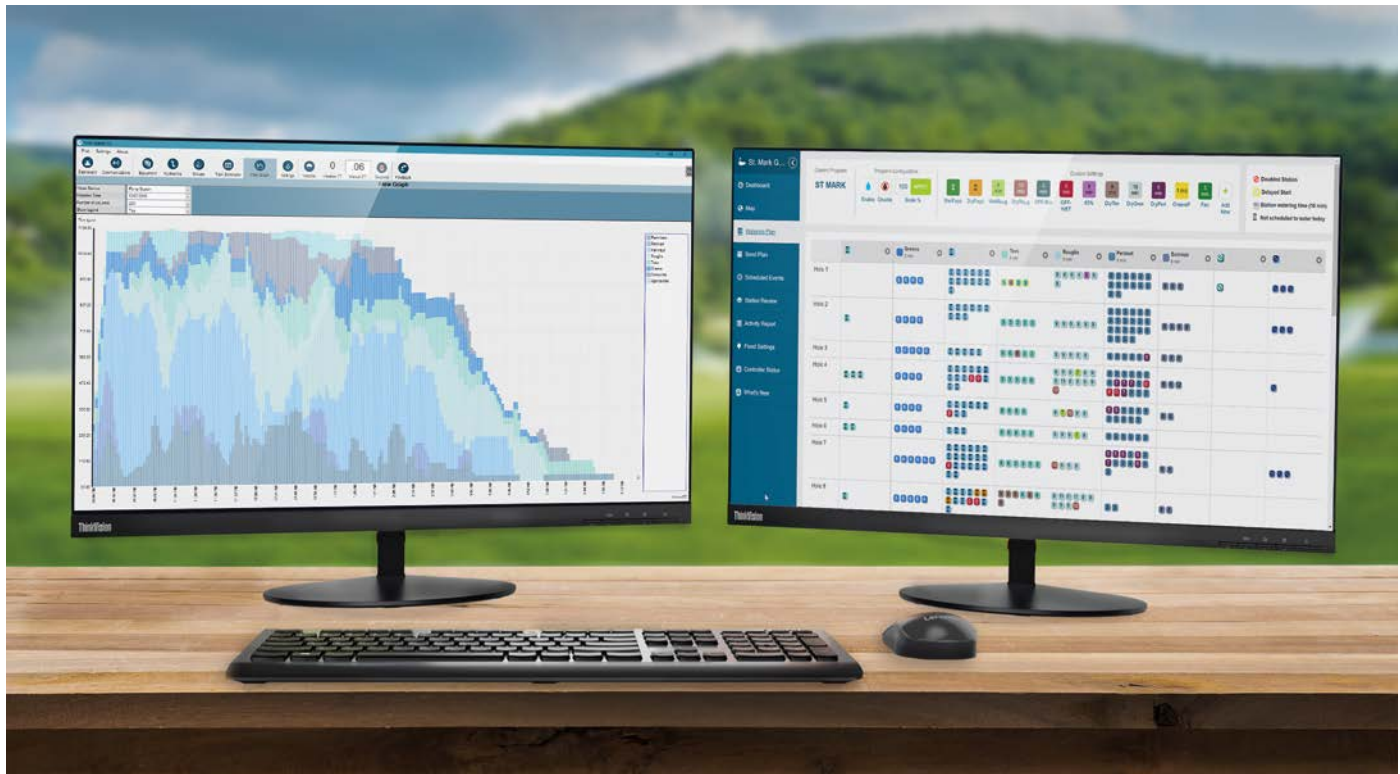

Windows is a trademark of Microsoft Corporation in the United States and/or other countries.
Lenovo® and ThinkVision® are trademarks of Lenovo in the United States, other countries, or both.

COMMAND CENTER

Planning daily watering for your course has never been simpler. The Command Center shows every sprinkler on the course, logically arranged according to your personal management requirements. You can easily make daily adjustments with just a few clicks of the mouse.



Command Center

SPEND LESS TIME RUNNING YOUR PUMP

Pilot CCS uses your electrical and hydraulic data to efficiently balance sprinkler demand while maintaining flow at safe velocities. To protect your pump station and maintain optimal sprinkler uniformity, you can gradually step up irrigation in safe increments.



Flow Optimisation

MAPPING YOUR COURSE

Although having a map is not required, adding one allows you to run water by simply clicking the station symbols on the map. With this helpful feature, you can also monitor stations as they are running.

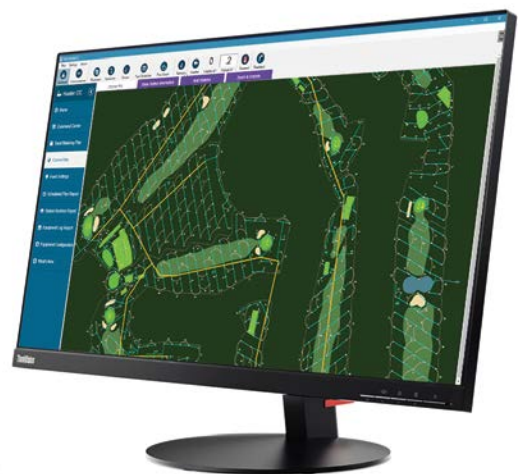

Maps

PILOT™ FIELD CONTROLLER SYSTEMS

The sleek, clean design of Pilot Field Controllers makes them easy to install, use, and maintain.

KEY BENEFITS

- Five languages
- Up to 80 station outputs in 10-station increments
- Up to three Hunter golf Valve-in-Head Technology rotors per station output
- Up to 20 simultaneous Hunter golf Valve-in-Head Technology rotors active per controller
- 32 automatic schedules with eight start times per schedule
- Exclusive Safe-Toggle™ Technology for mechanical on-off-auto station switches
- 1-31 day skip-day scheduling
- One-touch rain shutdown up to 30 days or indefinitely
- One-touch Safe-Pause™ Technology with 30-minute safety timer
- 1-300% run time seasonal adjustment
- Seasonal start time adjustment is used to quickly change all start times plus or minus 30 minutes
- PilotFCP Utility enables remote scheduling from a computer or tablet for basic course irrigation management



Pilot-FC Plastic Pedestal

Height: 100 cm
Width: 60 cm
Depth: 44 cm
Weight: 32 kg

POWER SUPPLY INPUT

Two voltage settings:

- 120 VAC nominal voltage at 60/50 Hz (100 to 132 VAC)
- 230 VAC nominal voltage at 50/60 Hz (200 to 260 VAC)

Current requirement:

- 1 A under load at 110 VAC
- 0.7 A under load at 230 VAC

For additional information, see electrical data on [page 248](#)



Pilot-FI Field Interface

One is required with any Pilot Network system. It is used to link the central computer to the field equipment. For indoor locations only.

Height: 30 cm
Width: 30 cm
Depth: 11 cm
Weight: 2 kg

OUTPUT VOLTAGE

- Station: 1 A at 24 VAC
- Hot post: 0.4 A at 24 VAC
- Capacity: Three standard 24 VAC Hunter golf rotors per output; 20 maximum simultaneously running stations

RADIO SYSTEMS

- UHF radio: 450-490 MHz; other UHF frequencies available for selected markets

WIRED SYSTEMS

- GCBL: Shielded two twisted pairs, 0.82 mm²
- GCBLA: Armoured, shielded two twisted pairs, 0.82 mm²

PILOT-FI – SPECIFICATION BUILDER: ORDER 1 + 2 + 3

1 Model	2 Standard Features	3 Communication Options
Pilot-FI	Plastic pedestal (grey)	<p>HWR Hardwire communications</p> <p>UHF UHF radio communications (licence required)</p> <p>UHFA UHF radio (licence required, Australia only)</p>

Examples:

Pilot-FI-HWR = Field Interface with hardwire communications

Pilot-FI-UHF = Field Interface with UHF radio communications

THE PILOT FIELD CONTROLLER IS ENGINEERED EXCLUSIVELY FOR GOLF COURSE IRRIGATION MANAGEMENT

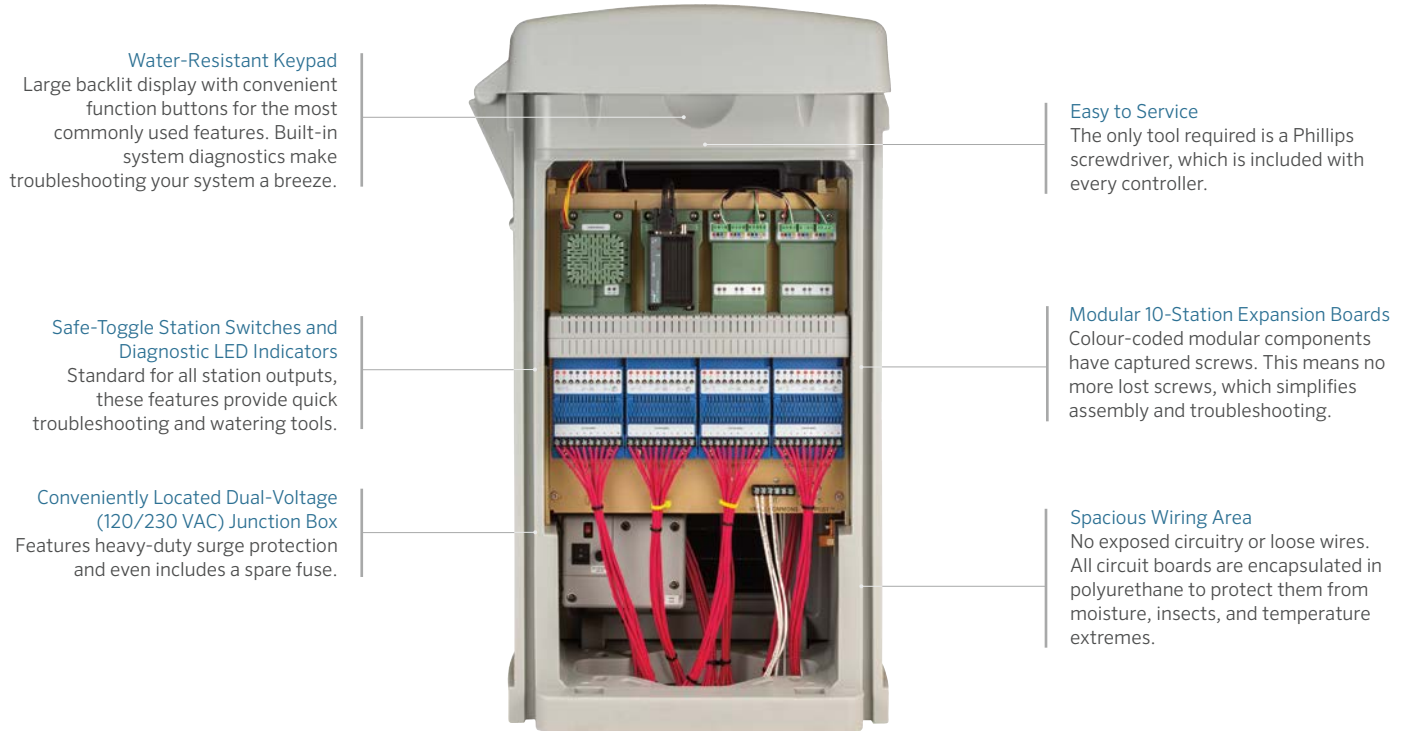

Water-Resistant Keypad
Large backlit display with convenient function buttons for the most commonly used features. Built-in system diagnostics make troubleshooting your system a breeze.

Easy to Service
The only tool required is a Phillips screwdriver, which is included with every controller.

Safe-Toggle Station Switches and Diagnostic LED Indicators
Standard for all station outputs, these features provide quick troubleshooting and watering tools.

Modular 10-Station Expansion Boards
Colour-coded modular components have captured screws. This means no more lost screws, which simplifies assembly and troubleshooting.

Conveniently Located Dual-Voltage (120/230 VAC) Junction Box
Features heavy-duty surge protection and even includes a spare fuse.

Spacious Wiring Area
No exposed circuitry or loose wires. All circuit boards are encapsulated in polyurethane to protect them from moisture, insects, and temperature extremes.

PILOT-FC - SPECIFICATION BUILDER: ORDER 1 + 2 + 3

1 Model	2 Standard Features	3 Communication Options
Pilot-FC20 (20-station)	Plastic pedestal (grey) 120/230 VAC, 60/50 Hz dual-voltage transformer	S Standalone Field Controller with no central communications
Pilot-FC30 (30-station)		HWR Wired communications
Pilot-FC40 (40-station)		UHF UHF radio (licence required)
Pilot-FC50 (50-station)		UHFA UHF radio (licence required, Australia only)
Pilot-FC60 (60-station)		
Pilot-FC70 (70-station)		
Pilot-FC80 (80-station)		

Examples:
Pilot-FC40-S = 40-station, standalone Field Controller with no central communications
Pilot-FC70-HWR = 70-station Field Controller with wired communications

PILOT™ INTEGRATED HUB SYSTEMS

Save money without sacrificing in-field sprinkler control with highly flexible and reliable Pilot Integrated Hub Systems.

Integrated Hub Systems use significantly less wire than conventional systems. This means lower costs, faster installation, and easier system diagnosis and repair if needed. They can be easily expanded — with minimal digging and disruption of turf — by adding more two-way modules (TWMs) instead of running additional wires.

Pilot Two-Way Modules are available with 1-, 2-, 4-, and 6-station outputs, making it possible to run each head on an entire green with a single device. In all, TWMs let you operate about 1,000 stations up to approximately 2½ km from a single hub.

Pilot Two-Way Modules include built-in surge suppression, wirelessly programmable station addresses using the ICD-HP Programmer, and two-way communication with confirmation and status indication. Pilot-SG Surge Suppressors are required when the system is installed with integrated TWMs.

PilotFCP Utility enables remote scheduling from a computer or tablet for basic course irrigation management. It can be directly connected to a Pilot controller, eliminating the need for a Pilot-FI and communication module in smaller systems.



TWM Hub

Water-Resistant Keypad

The backlit display and illuminated control panel mean you can easily access the hub, day or night

Diagnostic LED Indicators

For all functions on 250-station output modules

250-Station Output Modules

Enable your Integrated Hub System to expand with your course; start with 250 and grow to 999

Pilot TWMs

1- and 2-station:
Height: 9 cm
Width: 4 cm
Depth: 2.5 cm
Weight: 150 g

4- and 6-station:
Height: 9 cm
Width: 4.5 cm
Depth: 4 cm
Weight: 250 g



The distinct yellow design makes it much easier to find the modules in dark valve boxes or buried in the soil.

PILOT-SG Surge Suppressor

All integrated TWM rotors include two 3M DBRY-6 splices for connection to the two-wire path. Integrated TWM systems require grounding with Pilot Surge Suppressors coupled to an appropriate grounding plate or rod. Hunter recommends a minimum of one Pilot-SG for every 12 installed rotors or as per project specification.



PILOT-DH - SPECIFICATION BUILDER: ORDER 1 + 2 + 3

1 Model	2 Standard Features	3 Communication Options
Pilot-DH250 (250-station)	Plastic pedestal (grey) 120/230 VAC, 60/50 Hz switching transformer	S Standalone TWM hub with no central communications
Pilot-DH500 (500-station)		HWR Wired communications
Pilot-DH750 (750-station)		UHF UHF radio (licence required)
Pilot-DH999 (999-station)		UHFA UHF radio (licence required, Australia only)

Examples:

Pilot-DH250-S = 250-station, standalone TWM hub with no central communications

Pilot-DH999-HWR = 999-station TWM hub with wired communications

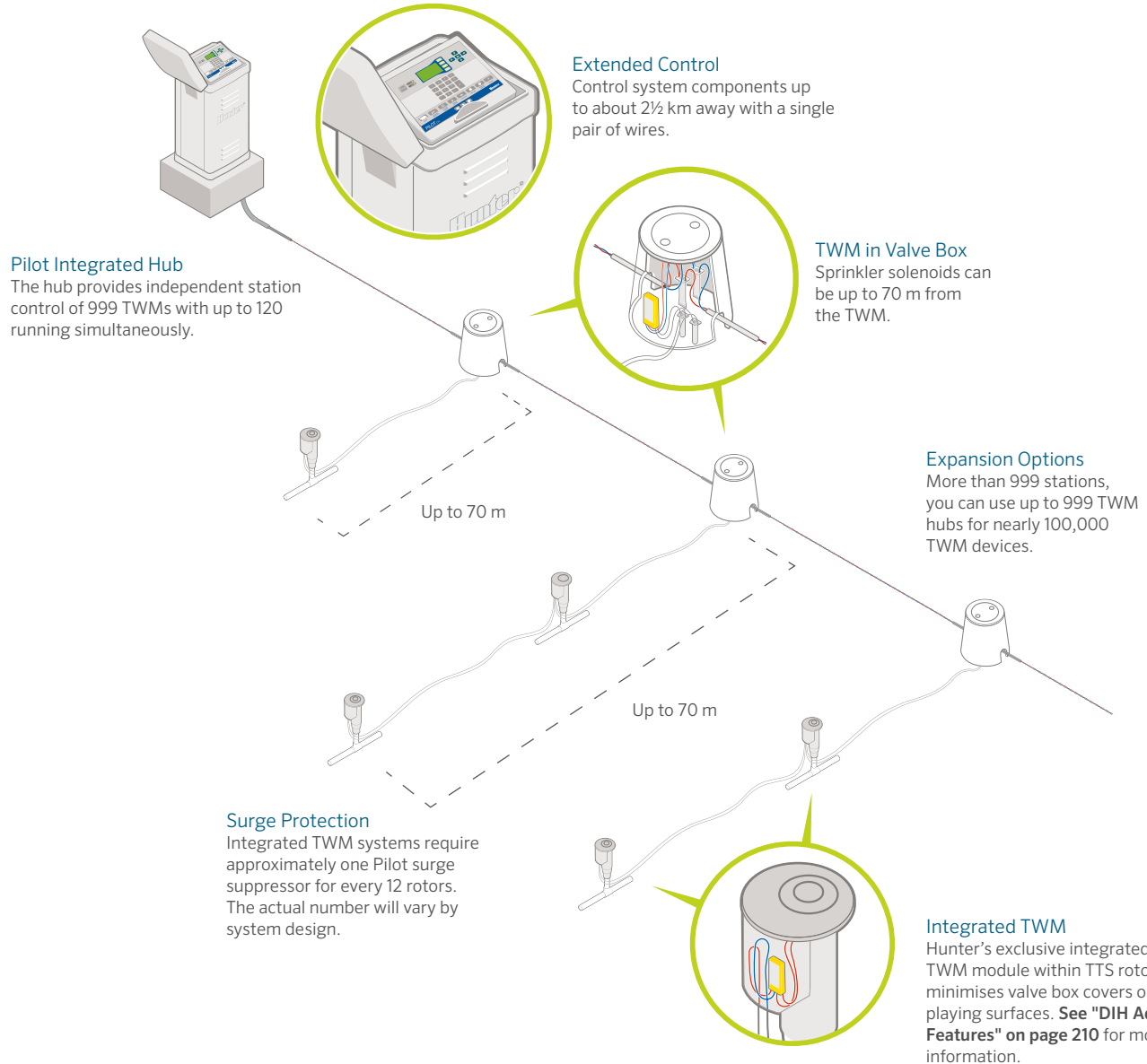

TWM - SPECIFICATION BUILDER: ORDER 1		
1	Model	2 Standard Features
Pilot-100	1-station TWM	Built-in surge suppressor
Pilot-200	2-station TWM	DBRY-6 waterproof connectors included
Pilot-400	4-station TWM	
Pilot-600	6-station TWM	
Pilot-SG	Inline surge suppression (for integrated TWM rotor systems)	

Example:
Pilot-100 = 1-station TWM



Wireless Programming

The ICD-HP Programmer is used to test, troubleshoot, and program integrated TWMs. It allows you to wirelessly link directly to TWMs without removing the TTS cover. You can also use it to update the coding inside the TWM's microprocessor.

See the ICD-HP on page 203

WEATHER STATION

Achieve and maintain the highest-quality playing surface with consistent, local weather data.

KEY BENEFITS

- Includes built-in 60-day data logger: With onboard evapotranspiration (ET) calculation (modified Penman-Monteith equation for turfgrass)
- Wireless package uses 2.4 GHz licence-free technology
 - 2.4 GHz radio systems can reach up to 3 km
 - In rural areas, try the licence-free, 900 MHz radio for links up to 800 m
- Wired systems use Hunter GCBL, direct-bury cable with a range of 1.25 km (dedicated nine-pin serial computer port required)
- Optional solar panel kit provides wireless power
 - Simple installation and versatile mounting with onboard 800 mAh rechargeable gel cell battery with 18 VDC transformer and 7 m power cable
- Weatherproof construction: With UV-stabilised enclosure, weatherproof external connectors, and long-life coated circuit boards
- UL, cUL, and CE certifications



TurfWeather® Station

Height: 61 cm
Width: 40.5 cm
Depth: 38 cm
Weight: 6 kg

COMPLETE PACKAGES INCLUDE HUNTER WEATHER SOFTWARE

Model	Description
TWHW	Wired communications to central computer (GCBL cable required)
TW24	2.4 GHz licence-free radio communication to central computer
TW916	916 MHz licence-free radio communication to central computer
TW922A	922 MHz licence-free radio communication to central computer
TWSUN	Optional Solar Power Kit for all TurfWeather models

MAINTENANCE RADIO

Save time and money with seamlessly integrated remote radio control.

KEY BENEFITS

- Hunter's innovative StraightTalk™ Technology enables wireless remote control at ranges up to 3.5 km whether or not the central computer is turned on
- Instant control of stations, blocks, and programs
- Instant audio confirmation of commands
- Easy commands that show in display before sending
- Compact size, industrial construction
- Suitable for two-way voice communication with crews and office
- High signal output: 2 W, UHF (450–490 MHz)*

* Licence required



TRNR Radio

Height: 10.25 cm
Width: 5.25 cm
Depth: 3 cm
Weight: 200 g

ICD-HP PROGRAMMER

Gain wireless, handheld programming and diagnostic capabilities for Pilot Two-Way Modules.

KEY BENEFITS

- Wirelessly program TWM addresses
- Program TWM station numbers in any order, or skip stations for future expansion
- Turn stations on and view solenoid status, current in milliamps, and more
- Built-in voltmeter for testing communication path
- Communicates with TWMs directly through plastic case; wireless electromagnetic induction saves waterproof connectors
- Communicates through the top of integrated TWM rotor cases; no cover removal required



ICD-HP

Height: 21 cm
Width: 9 cm
Depth: 5 cm

Packaged in an outdoor carrying case, this complete kit includes probes, an induction cup, cable, a USB power cable for bench use, and four AA batteries for fieldwork.

ICD-HP



ROTOR SOLUTIONS FOR EVERY GOLF COURSE

INTRODUCING THE TTS-800 SERIES: THE MOST ADVANCED ROTORS IN THE GOLF INDUSTRY

Over the last three decades, Hunter Industries has built a longstanding reputation for innovation in the golf industry. Introductions such as the first Windows-based central control system, the first Total-Top-Service (TTS) rotors, the first Decoder-in-Head (DIH) rotors with integrated two-way modules, and the powerful and water-efficient G-85 gear drives are among these revolutionary innovations.

Now, we are proud to advance our legacy of firsts with our all-new TTS-800 Series Golf Rotors — the most innovative and technologically advanced rotors in the industry. TTS-800 Series Golf Rotors provide maximum uniformity and longevity in the field. The high-torque gear drives are the strongest in the industry, so the potential challenges of reclaimed water use or poor water quality are mitigated. The fast-access flange compartment is the largest in the industry and can accommodate full-sized DBRY-6 splice connectors. And with no-dig Total-Top-Serviceability, TTS-800 Series Golf Rotors provide solenoid and pressure regulator servicing without mainline depressurisation, making routine maintenance a breeze.

So, whether your golf rotor needs fall into our budget-conscious B Series, the advanced G-800 Series, or our top-of-the-line TTS-800 Series, Hunter Industries offers total solutions that will exceed your expectations and ensure beautiful, playable courses for years to come.



GOLF ROTORS



Look for this icon. All Hunter Golf rotors are 100% water-tested to ensure reliable operation once installed.



UNIFORMITY **YOU CAN COUNT ON**

Playability and water efficiency go hand-in-hand when it comes to golf course management. This means great distribution uniformity and proper irrigation scheduling are crucial to ensuring world-class performance and beautiful results.

Healthy, playable turf starts with top-level irrigation products — like Hunter's ultra-reliable TTS-800 Series Golf Rotors, with their superior distribution uniformity. Couple this with the best support team in the business, and Hunter's golf solutions are second to none.

At Hunter Golf, we pride ourselves in providing products that set the standard in efficiency. Each year, we work directly with golf course superintendents worldwide to conduct comprehensive irrigation system audits that maximise water savings, reduce operating costs, and enhance the golf experience for players and course managers alike.

Choose Hunter Golf products for best-in-class performance and enhanced playability.

BEST-IN-CLASS GEAR DRIVES

POWER, PERFORMANCE, AND VERSATILITY



HIGHLY POWERFUL GEAR DRIVES

MEET THE G-80 FULL-CIRCLE DIRECT-DRIVE DYNAMO

In 2013, Hunter introduced the revolutionary G-85 gear drive, the most powerful in the golf industry. Since then, the G-85's reputation for power, performance, and versatility have earned the respect of professionals industry-wide. While the G-85 has an adjustable arc drive with triple forward-facing nozzles, it can also be adjusted to non-reversing, full-circle rotation. In addition, the G-85 can be configured at the factory as a G-84 in an opposing-nozzle, full-circle configuration.

Now, Hunter completes the trilogy with the direct-drive G-80 full-circle dynamo — with power to spare. The dedicated full-circle G-80 melds the tried-and-proven 2006 to 2018 G-80 gearbox with the G-85's outstanding platform to create the best full-circle gear drive in the golf industry.

DUAL-TRAJECTORY FLEXIBILITY



Standard Nozzles



Low-Angle Nozzles

The G-80 and the G-84/G-85 gear drives share the same primary nozzle sets. Each gear drive has dedicated short- and mid-range nozzles that when combined with the primary nozzles create the uniformity you can count on. Choose from a wide assortment of efficient wind-fighting 22.5° standard trajectory nozzles, or 15° low-angle trajectory nozzles.

Either way, there is a perfect match for your unique course conditions and problem-solving needs. Regardless of the version you choose, changing nozzles is fast and easy with Hunter's exclusive QuickChange Technology.

TTS-800 SERIES GOLF ROTORS

ADVANCED FEATURES

Total-Top-Service (TTS)



Access Everything Through the Top

This no-dig solution is appreciated by golfers, management, and especially the superintendent

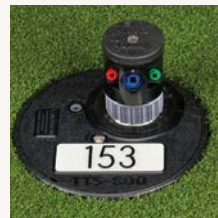

Large and Flexible Yardage Marker Capabilities

Oversized marker plates with standard black or red, white, blue, and purple options



Largest Flange Compartment in the Industry

Spacious cavity with enough room for full-sized 3M DBRY-6 splice connectors



Unitized Inlet Valve Design Includes Serviceable Components

Contamination damage is quickly resolved with replaceable valve seat and seat-seal



Easy Access and Servicing of Solenoid and Pressure Regulators

Colour-coded components are removed and replaced without mainline depressurisation

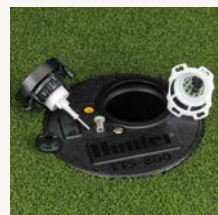

Exclusive Inlet Valve Includes Self-Cleaning Capabilities

Proprietary Filter Sentry™ Mechanism wipes debris from the stainless steel screen with every activation



Single-Point Fast-Access to Flange Compartment

Extra-thick compartment lid is retained with stainless steel ¼-turn fastener

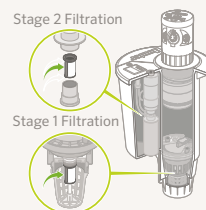

Two-Stage Serviceable Filtration in Valve Circuitry

Oversized stainless steel screens at inlet valve and pilot valve are easily cleaned or replaced



Heavy-Duty Flanged and Ribbed Body Design

Impact-resistant and ultra-durable design includes extra-strength PVC Acme inlet



Three Cable Entry Ports at Base of Flange Compartment

Makes splice and cable connections fast, easy, and organised



Low-Bounce Rubber Cover Kit

Impact-absorbing design reduces ball ricochet around the greens



No-Bounce Turf Cup Kit

Recessed turf cup design is aesthetically clean and eliminates ball ricochet



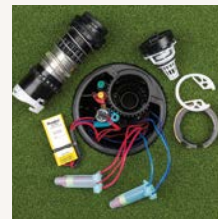

Access Everything, Including Two-Way Modules, Through the Top

This no-dig solution is appreciated by golfers, management, and especially the superintendent

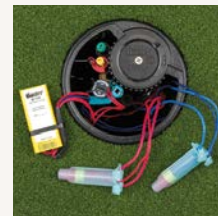

Largest Flange DIH Compartment in the Industry

Spacious cavity with enough room for two-way modules and full-sized 3M DBRY-6 splice connectors



Two-Way Modules Are Housed in the DIH Rotor's Spacious Flange Compartment

Improves playability and eliminates unsightly enclosures around the course



Programming Two-Way Modules Wirelessly From the Surface with No Disassembly

Quick and easy to program and perform diagnostics before or after installation with ICD-HP

TTS-800 SERIES GOLF ROTORS

ADVANCED FEATURES



Individual Two-Way Module and Solenoid Components Within Flange Compartment

Isolated/separated configuration minimises yearly maintenance costs

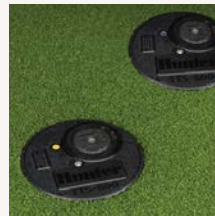

Two-Station DIH Rotor Option

Perfect cost-effective solution for back-to-back heads around greens



State-of-the-Art Surge Suppression

Earth grounding is easily added with the Pilot-SG Surge Suppressor

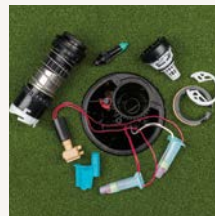

DIH Rotors Include All the Unique Features and Benefits of TTS Rotors

Makes splice and cable connections fast, easy, and clean



Seamless No-Splice Connection Between Two-Way Module and Solenoid

With no connectors, maintains ongoing electrical continuity

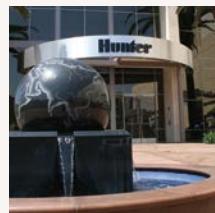

Durability, Efficiency, and Reliability from the Makers of the Industry's First TTS and DIH Rotors

Peace of mind from the world's leading producer of gear-driven rotors

TTS-800 SERIES



These rotors have Total-Top-Serviceability, powerful high-torque gear drives, and the largest flange compartment in the industry to accommodate all two-way module components.

KEY BENEFITS

- Dedicated, true full-circle model distinguished by a black collar
- Extra-large, fast access flange compartment to accommodate full-size DBRY-6 splice connectors and an integrated two-way module
- Solenoid and pressure regulator are serviceable without system depressurization
- Exclusive PressurePort™ Technology optimizes incoming pressure at each nozzle to increase consistency and maximize distribution uniformity
- High-torque gear drive is the strongest in the industry to mitigate the challenges of debris infiltration
- Proprietary Filter Sentry® Mechanism cleans the filter with every opening and closing cycle
- All TTS-800 Series Golf Rotors advanced features listed on **pages 208 to 211**

OPERATING SPECIFICATIONS

- Radius: 14.9 to 29.6 m
- Flow: 3.23 to 13.29 m³/hr; 53.8 to 221.4 l/min
- Pressure range: 3.4 to 6.9 bar; 340 to 690 kPa
- All TTS rotors are pressure-rated at 10 bar; 1,000 kPa
- Nozzle range: #15 to #53
 - 10 standard trajectory (22.5°)
 - 9 low-angle trajectory (15°)

OPTIONS

- C – Check-o-Matic Technology checks up to 8 m in elevation change and readily converts to normally open hydraulic with through-the-top connections
- D – Decoder Valve-in-Head Technology with all “E” specifications below*
- DD – Two-station decoder Valve-in-Head Technology with all “E” specifications below*
- E – Electric Valve-in-Head Technology with adjustable pressure regulation, on-off-auto selector, 210 mA (370 mA inrush) 50 Hz; 190 mA (350 mA inrush) 60 Hz solenoid with captive plunger and internal downstream bleed

* All DIH rotors include two 3M DBRY-6 splices for connection to the two-wire path. See **page 200** for critical recommendations on grounding DIH rotors.



GT-880

Pop-up height: 9.5 cm
Overall height: 30 cm
Flange diameter: 18 cm
Female inlet: 1½" (40 mm) Acme

GT-880 – SPECIFICATION BUILDER: ORDER 1 + 2 + 3 + 4

1 Model	2 Valve Options	3 Nozzle	4 Regulation
GT-880 = Full-circle	<p>C = Check-o-Matic Technology*</p> <p>D = Decoder Valve-in-Head Technology</p> <p>DD = Two-station decoder Valve-in-Head Technology</p> <p>E = Electric Valve-in-Head Technology</p> <p>*Converts to N.O. hydraulic Valve-in-Head Technology</p>	15 to 53 = Installed G-880 nozzle	<p>P5 = 50 PSI; 3.4 bar; 340 kPa (nozzles 15 to 18)</p> <p>P6 = 65 PSI; 4.5 bar; 450 kPa (nozzles 18 to 25)</p> <p>P8 = 80 PSI; 5.5 bar; 550 kPa (nozzles 25 to 53)</p>

Example:

GT-880-E-48-P8 = GT-880 full-circle electric Valve-in-Head Technology, installed #48 nozzle, 80 PSI; 5.5 bar; 550 kPa regulation

GT-880 NOZZLE PERFORMANCE DATA*										
Nozzle Set			Pressure		Radius		Flow		Precip mm/hr	
			bar	kPa	m	m ³ /hr	l/min	■	▲	
●	○	●	3.4	344	14.9	3.23	53.8	14.5	16.7	
Tan	15	Grey	4.1	413	15.5	3.57	59.4	14.8	17.0	
803611		White	4.5	450	15.9	3.73	62.1	14.8	17.1	
803611		315317	4.8	482	16.2	3.86	64.4	14.8	17.1	
803611		315317	5.5	551	16.8	4.13	68.9	14.7	17.0	
●	○	●	3.4	344	17.1	3.91	65.1	13.4	15.5	
Tan	18	Grey	4.1	413	17.7	4.28	71.3	13.7	15.8	
803611		Orange	4.5	450	18.0	4.48	74.6	13.8	16.0	
803611		315317	4.8	482	18.3	4.54	75.7	13.6	15.7	
803611		315317	5.5	551	18.6	4.82	80.3	13.9	16.1	
●	○	●	3.4	344	17.4	4.18	69.7	13.8	16.0	
Tan	20	Grey	4.1	413	18.0	4.61	76.8	14.3	16.5	
803611		Brown	4.5	450	18.6	4.86	81.0	14.1	16.2	
803611		315317	4.8	482	19.2	4.91	81.8	13.3	15.4	
803611		315317	5.5	551	19.5	5.16	85.9	13.5	15.6	
●	○	●	3.4	344	19.2	4.91	81.8	13.3	15.4	
Tan	23	Lt. Blue	4.1	413	19.8	5.22	87.1	13.3	15.4	
803611		Green	4.5	450	20.1	5.45	90.8	13.5	15.6	
803611		315311	4.8	482	20.4	5.66	94.3	13.6	15.7	
803611		315311	5.5	551	20.7	6.04	100.7	14.1	16.2	
●	○	●	4.5	450	21.6	6.50	108.3	13.9	16.0	
Tan	25	Lt. Blue	4.8	482	22.3	6.75	112.5	13.6	15.7	
803611		Blue	5.5	551	22.6	7.19	119.8	14.1	16.3	
803611		315311	6.2	620	22.9	7.65	127.5	14.6	16.9	
803611		315311	6.9	689	23.5	8.12	135.3	14.7	17.0	
●	○	●	4.5	450	22.6	7.02	117.0	13.8	15.9	
Tan	33	Lt. Blue	4.8	482	22.9	7.27	121.1	13.9	16.1	
803611		Grey	5.5	551	23.5	7.77	129.5	14.1	16.3	
803611		315311	6.2	620	24.1	8.22	137.0	14.2	16.4	
803611		315311	6.9	689	24.7	8.68	144.6	14.2	16.4	
●	○	●	4.5	450	23.5	7.97	132.9	14.5	16.7	
Tan	38	Lt. Blue	4.8	482	24.1	8.31	138.5	14.3	16.6	
803611		Red	5.5	551	25.0	8.84	147.3	14.1	16.3	
803611		315311	6.2	620	25.6	9.38	156.3	14.3	16.5	
803611		315311	6.9	689	26.5	9.90	165.0	14.1	16.3	
●	○	●	-	-	-	-	-	-	-	
Tan	43	Blue	4.8	482	25.3	9.38	156.3	14.7	16.9	
803611		Dk. Brown	5.5	551	25.9	9.90	165.0	14.8	17.0	
803611		315300	6.2	620	26.5	10.52	175.3	15.0	17.3	
803611		315300	6.9	689	27.1	11.09	184.7	15.1	17.4	
●	○	●	-	-	-	-	-	-	-	
Dk. Brown	48	Dk. Blue	4.8	482	27.4	10.65	177.5	14.2	16.3	
803610		Dk. Green	5.5	551	28.0	11.11	185.1	14.1	16.3	
803610		833500	6.2	620	28.7	11.46	191.0	14.0	16.1	
803610		833500	6.9	689	29.3	12.15	202.5	14.2	16.4	
●	○	●	-	-	-	-	-	-	-	
Dk. Brown	53	Dk. Blue	4.8	482	27.7	11.31	188.5	14.7	17.0	
803610		Dk. Blue	5.5	551	28.3	11.86	197.7	14.8	17.0	
803610		833500	6.2	620	29.0	12.61	210.1	15.0	17.4	
803610		833500	6.9	689	29.6	13.29	221.4	15.2	17.6	

* Complies to ASAE standard. All precipitation rates calculated for 360° operation. All triangular rates are equilateral. To calculate precipitation rates for 180° operation, multiply by 2.

GT-880 STANDARD NOZZLES GT-880 LOW-ANGLE NOZZLES**



** Low-angle nozzles reduce the radius by 15%.



Easy-Access Servicing

An extra-thick compartment lid is retained with a ¼-turn, stainless steel, single-point fastener.



Spacious Flange Compartment

The largest and deepest compartment in the industry offers plenty of room for full-sized DBRY-6 splice connectors.

TTS-800 SERIES



These rotors have Total-Top-Serviceability, powerful high-torque gear drives, and the largest flange compartment in the industry to accommodate all two-way module components.

KEY BENEFITS

- Adjustable model distinguished by a grey collar that comes factory set in a true full-circle configuration
- Extra-large, fast access flange compartment to accommodate full-size DBRY-6 splice connectors and an integrated two-way module
- Solenoid and pressure regulator are serviceable without system depressurization
- Exclusive PressurePort™ Technology optimizes incoming pressure at each nozzle to increase consistency and maximize distribution uniformity
- High-torque gear drive is the strongest in the industry to mitigate the challenges of debris infiltration
- Proprietary Filter Sentry® Mechanism cleans the filter with every opening and closing cycle
- All TTS-800 Series Golf Rotors advanced features listed on **pages 208 to 211**



GT-884

Pop-up height: 9.5 cm
Overall height: 30 cm
Flange diameter: 18 cm
Female inlet: 1/2" (40 mm) Acme

OPERATING SPECIFICATIONS

- Radius: 14.9 to 29.6 m
- Flow: 3.23 to 13.29 m³/hr; 53.8 to 221.4 l/min
- Pressure range: 3.4 to 6.9 bar; 340 to 690 kPa
- All TTS rotors are pressure-rated at 10 bar; 1,000 kPa
- Nozzle range: #15 to #53
 - 10 standard trajectory (22.5°)
 - 9 low-angle trajectory (15°)

OPTIONS

- C - Check-o-Matic Technology checks up to 8 m in elevation change and readily converts to normally open hydraulic with through-the-top connections
- D - Decoder Valve-in-Head Technology with all "E" specifications below*
- DD - Two-station decoder Valve-in-Head Technology with all "E" specifications below*
- E - Electric Valve-in-Head Technology with adjustable pressure regulation, on-off-auto selector, 210 mA (370 mA inrush) 50 Hz; 190 mA (350 mA inrush) 60 Hz solenoid with captive plunger and internal downstream bleed

* All DIH rotors include two 3M DBRY-6 splices for connection to the two-wire path. See **page 200** for critical recommendations on grounding DIH rotors.

GT-884 - SPECIFICATION BUILDER: ORDER 1 + 2 + 3 + 4

1 Model	2 Valve Options	3 Nozzle	4 Regulation
GT-884 = Full-circle (convertible to forward-facing adjustable arc rotor)	C = Check-o-Matic Technology* D = Decoder Valve-in-Head Technology DD = Two-station decoder Valve-in-Head Technology E = Electric Valve-in-Head Technology * Converts to N.O. hydraulic Valve-in-Head Technology	15 to 53 = Installed G-880 nozzle	P5 = 50 PSI; 3.4 bar; 340 kPa (nozzles 15 to 18) P6 = 65 PSI; 4.5 bar; 450 kPa (nozzles 18 to 25) P8 = 80 PSI; 5.5 bar; 550 kPa (nozzles 25 to 53)

Example:

GT-884-E-48-P8 = GT-884 full-circle electric Valve-in-Head Technology, installed #48 nozzle, 80 PSI; 5.5 bar; 550 kPa regulation

GT-884 NOZZLE PERFORMANCE DATA*									
Nozzle Set			Pressure		Radius	Flow		Precip mm/hr	
			bar	kPa	m	m ³ /hr	l/min	■	▲
●	○	●	3.4	344	14.9	3.23	53.8	14.5	16.7
Tan	15	Grey	4.1	413	15.5	3.57	59.4	14.8	17.0
803611		White	4.5	450	15.9	3.73	62.1	14.8	17.1
803611		315317	4.8	482	16.2	3.86	64.4	14.8	17.1
803611		315317	5.5	551	16.8	4.13	68.9	14.7	17.0
●	○	●	3.4	344	17.1	3.91	65.1	13.4	15.5
Tan	18	Grey	4.1	413	17.7	4.28	71.3	13.7	15.8
803611		Orange	4.5	450	18.0	4.48	74.6	13.8	16.0
803611		315317	4.8	482	18.3	4.54	75.7	13.6	15.7
803611		315317	5.5	551	18.6	4.82	80.3	13.9	16.1
●	○	●	3.4	344	17.4	4.18	69.7	13.8	16.0
Tan	20	Grey	4.1	413	18.0	4.61	76.8	14.3	16.5
803611		Brown	4.5	450	18.6	4.86	81.0	14.1	16.2
803611		315317	4.8	482	19.2	4.91	81.8	13.3	15.4
803611		315317	5.5	551	19.5	5.16	85.9	13.5	15.6
●	○	●	3.4	344	19.2	4.91	81.8	13.3	15.4
Tan	23	Lt. Blue	4.1	413	19.8	5.22	87.1	13.3	15.4
803611		Green	4.5	450	20.1	5.45	90.8	13.5	15.6
803611		315311	4.8	482	20.4	5.66	94.3	13.6	15.7
803611		315311	5.5	551	20.7	6.04	100.7	14.1	16.2
●	○	●	4.5	450	21.6	6.50	108.3	13.9	16.0
Tan	25	Lt. Blue	4.8	482	22.3	6.75	112.5	13.6	15.7
803611		Blue	5.5	551	22.6	7.19	119.8	14.1	16.3
803611		315311	6.2	620	22.9	7.65	127.5	14.6	16.9
803611		315311	6.9	689	23.5	8.12	135.3	14.7	17.0
●	○	●	4.5	450	22.6	7.02	117.0	13.8	15.9
Tan	33	Lt. Blue	4.8	482	22.9	7.27	121.1	13.9	16.1
803611		Grey	5.5	551	23.5	7.77	129.5	14.1	16.3
803611		315311	6.2	620	24.1	8.22	137.0	14.2	16.4
803611		315311	6.9	689	24.7	8.68	144.6	14.2	16.4
●	○	●	4.5	450	23.5	7.97	132.9	14.5	16.7
Tan	38	Lt. Blue	4.8	482	24.1	8.31	138.5	14.3	16.6
803611		Red	5.5	551	25.0	8.84	147.3	14.1	16.3
803611		315311	6.2	620	25.6	9.38	156.3	14.3	16.5
803611		315311	6.9	689	26.5	9.90	165.0	14.1	16.3
●	○	●	-	-	-	-	-	-	-
Tan	43	Blue	4.8	482	25.3	9.38	156.3	14.7	16.9
803611		Dk. Brown	5.5	551	25.9	9.90	165.0	14.8	17.0
803611		315300	6.2	620	26.5	10.52	175.3	15.0	17.3
803611		315300	6.9	689	27.1	11.09	184.7	15.1	17.4
●	○	●	-	-	-	-	-	-	-
Dk. Brown	48	Dk. Blue	4.8	482	27.4	10.65	177.5	14.2	16.3
803610		Dk. Green	5.5	551	28.0	11.11	185.1	14.1	16.3
803610		833500	6.2	620	28.7	11.46	191.0	14.0	16.1
803610		833500	6.9	689	29.3	12.15	202.5	14.2	16.4
●	○	●	-	-	-	-	-	-	-
Dk. Brown	53	Dk. Blue	4.8	482	27.7	11.31	188.5	14.7	17.0
803610		Dk. Blue	5.5	551	28.3	11.86	197.7	14.8	17.0
803610		833500	6.2	620	29.0	12.61	210.1	15.0	17.4
803610		833500	6.9	689	29.6	13.29	221.4	15.2	17.6

* Preliminary performance data. Complies to ASAE standard. All precipitation rates calculated for 360° operation. All triangular rates are equilateral. To calculate precipitation rates for 180° operation, multiply by 2.

GT-884 STANDARD NOZZLES GT-884 LOW-ANGLE NOZZLES**



** Low-angle nozzles reduce the radius by 15%.

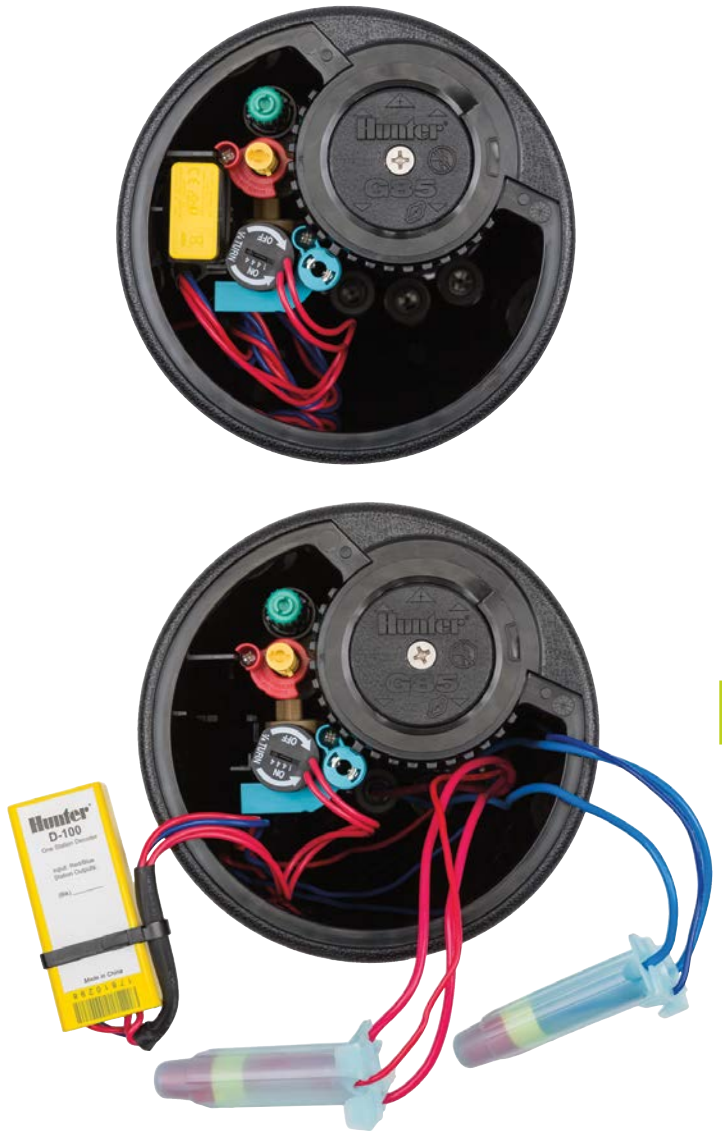

GOLF ROTORS

Room to Spare

Adding a two-way module does not reduce flange compartment space. The exclusive configuration provides extra room for full-sized DBRY-6 splice connectors and multiple cables.

TTS-800 SERIES



These rotors have Total-Top-Serviceability, powerful high-torque gear drives, and the largest flange compartment in the industry to accommodate all two-way module components.

KEY BENEFITS

- Adjustable model distinguished by a grey collar that comes factory set in a part-circle configuration (60° to 360°)
- Extra-large, fast access flange compartment to accommodate full-size DBRY-6 splice connectors and an integrated two-way module
- Solenoid and pressure regulator are serviceable without system depressurization
- Exclusive PressurePort™ Technology optimizes incoming pressure at each nozzle to increase consistency and maximize distribution uniformity
- High-torque gear drive is the strongest in the industry to mitigate the challenges of debris infiltration
- Proprietary Filter Sentry® Mechanism cleans the filter with every opening and closing cycle
- All TTS-800 Series Golf Rotors advanced features listed on **pages 208 to 211**

OPERATING SPECIFICATIONS

- Radius: 11.3 to 28.7 m
- Flow: 2.02 to 13.54 m³/hr; 33.7 to 225.6 l/min
- Pressure range: 3.4 to 6.9 bar; 340 to 690 kPa
- All TTS rotors are pressure-rated at 10 bar; 1,000 kPa
- Nozzle range: #10 to #53
 - 12 standard trajectory (22.5°)
 - 9 low-angle trajectory (15°)

OPTIONS

- C - Check-o-Matic Technology checks up to 8 m in elevation change and readily converts to normally open hydraulic with through-the-top connections
- D - Decoder Valve-in-Head Technology with all “E” specifications below*
- DD - Two-station decoder Valve-in-Head Technology with all “E” specifications below*
- E - Electric Valve-in-Head Technology with adjustable pressure regulation, on-off-auto selector, 210 mA (370 mA inrush) 50 Hz; 190 mA (350 mA inrush) 60 Hz solenoid with captive plunger and internal downstream bleed

* All DIH rotors include two 3M DBRY-6 splices for connection to the two-wire path. See **page 200** for critical recommendations on grounding DIH rotors.



GT-885

Pop-up height: 9.5 cm
Overall height: 30 cm
Flange diameter: 18 cm
Female inlet: 1/2" (40 mm) Acme

GT-885 – SPECIFICATION BUILDER: ORDER 1 + 2 + 3 + 4

1 Model	2 Valve Options	3 Nozzle	4 Regulation
GT-885 = Full/part-circle, 60°-360° arc range	C = Check-o-Matic Technology* D = Decoder Valve-in-Head Technology DD = Two-station decoder Valve-in-Head Technology E = Electric Valve-in-Head Technology *Converts to N.O. hydraulic Valve-in-Head Technology	10 to 53 = Installed G-885 nozzle	P5 = 50 PSI; 3.4 bar; 340 kPa (nozzles 10 to 18) P6 = 65 PSI; 4.5 bar; 450 kPa (nozzles 18 to 25) P8 = 80 PSI; 5.5 bar; 550 kPa (nozzles 25 to 53)

Example:

GT-885-E-48-P8 = GT-885 full/part-circle electric Valve-in-Head Technology, installed #48 nozzle, 80 PSI; 5.5 bar; 550 kPa regulation

GT-885 NOZZLE PERFORMANCE DATA*									
Nozzle Set			Pressure		Radius	Flow		Precip mm/hr	
			bar	kPa	m	m ³ /hr	l/min	■	▲
Orange		Dk. Green	3.4	344	11.3	2.02	33.7	15.9	18.4
			4.1	413	11.9	2.23	37.1	15.8	18.2
			4.5	450	12.5	2.32	38.6	14.8	17.1
803603	10	315312	-	-	-	-	-	-	-
●			-	-	-	-	-	-	-
Orange		White	3.4	344	14.3	2.59	43.2	12.6	14.6
			4.1	413	14.6	2.79	46.6	13.1	15.1
			4.5	450	14.9	2.93	48.8	13.1	15.2
803603	13	315314	-	-	-	-	-	-	-
●			-	-	-	-	-	-	-
Orange		White	3.4	344	15.9	2.93	48.8	11.7	13.5
			4.1	413	15.9	3.29	54.9	13.1	15.1
			4.5	450	16.2	3.38	56.4	13.0	15.0
803603	15	315314	4.8	482	16.2	3.52	58.7	13.5	15.6
●			5.5	551	16.5	3.75	62.5	13.8	16.0
Orange		Lt. Green	3.4	344	17.4	3.77	62.8	12.5	14.4
			4.1	413	17.7	4.04	67.4	12.9	14.9
			4.5	450	18.0	4.23	70.4	13.1	15.1
803603	18	315313	4.8	482	18.3	4.41	73.4	13.2	15.2
●			5.5	551	18.6	4.66	77.6	13.5	15.6
Orange		Lt. Green	3.4	344	18.0	4.07	67.8	12.6	14.5
			4.1	413	18.6	4.43	73.8	12.8	14.8
			4.5	450	18.9	4.50	75.0	12.6	14.5
803603	20	315313	4.8	482	19.2	4.68	78.0	12.7	14.7
●			5.5	551	19.5	5.02	83.7	13.2	15.2
Orange		Lt. Green	3.4	344	19.8	4.59	76.5	11.7	13.5
			4.1	413	20.1	5.02	83.7	12.4	14.3
			4.5	450	20.4	5.43	90.5	13.0	15.0
803603	23	315313	4.8	482	20.4	5.50	91.6	13.2	15.2
●			5.5	551	21.0	5.88	98.0	13.3	15.4
Red		Green	4.5	450	21.6	6.43	107.1	13.7	15.8
			4.8	482	21.9	6.66	110.9	13.8	16.0
			5.5	551	22.3	7.16	119.2	14.5	16.7
803602	25	315310	6.2	620	22.6	7.59	126.4	14.9	17.2
●			6.9	689	22.9	8.04	134.0	15.4	17.8
Red		Green	4.5	450	21.9	6.95	115.8	14.4	16.7
			4.8	482	22.3	7.18	119.6	14.5	16.7
			5.5	551	22.9	7.70	128.3	14.7	17.0
803602	33	315310	6.2	620	23.5	8.13	135.5	14.8	17.0
●			6.9	689	24.1	8.61	143.5	14.8	17.1
Red		Green	4.5	450	23.2	7.93	132.1	14.8	17.1
			4.8	482	23.8	8.22	137.0	14.5	16.8
			5.5	551	24.4	8.88	148.0	14.9	17.2
803602	38	315310	6.2	620	25.0	9.36	156.0	15.0	17.3
●			6.9	689	25.6	9.88	164.7	15.1	17.4
Red		Green	-	-	-	-	-	-	-
			4.8	482	24.7	9.36	156.0	15.4	17.7
			5.5	551	25.3	9.88	164.7	15.4	17.8
803602	43	315310	6.2	620	26.2	10.49	174.9	15.3	17.6
●			6.9	689	27.1	11.06	184.3	15.0	17.4
Dk. Red		Dk. Green	-	-	-	-	-	-	-
			4.8	482	25.3	10.52	175.3	16.4	19.0
			5.5	551	25.9	10.99	183.2	16.4	18.9
803601	48	315312	6.2	620	27.1	11.74	195.7	16.0	18.4
●			6.9	689	27.7	12.38	206.3	16.1	18.6
Dk. Red		Dk. Green	-	-	-	-	-	-	-
			4.8	482	26.5	11.52	191.9	16.4	18.9
			5.5	551	27.1	12.06	201.0	16.4	18.9
803601	53	315312	6.2	620	28.0	12.81	213.5	16.3	18.8
●			6.9	689	28.7	13.54	225.6	16.5	19.0

● = Nozzle plug P/N 315300 installed in the back side of the nozzle housing.

* Complies to ASAE standard. All precipitation rates calculated for 360° operation. All triangular rates are equilateral. To calculate precipitation rates for 180° operation, multiply by 2.

GT-885 STANDARD NOZZLES

GT-885 LOW-ANGLE NOZZLES**



** Low-angle nozzles reduce the radius by 15%.

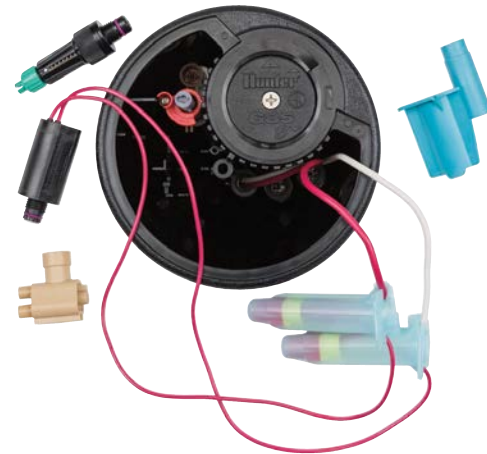

Reduced Downtime

There is no need to depressurise the mainline for solenoid and pressure regulator servicing.



Total-Top-Service Solution

From the originators of TTS technology, Hunter's no-dig TTS-800 Series Golf Rotators provide total-top-servicing of every serviceable component.

TTS-800 SERIES



These rotors have Total-Top-Serviceability, shorter-radius, lower-flow internals, and the largest flange compartment in the industry to accommodate all two-way module components.

KEY BENEFITS

- Adjustable, shorter radius model (50° to 360°)
- Extra-large, fast access flange compartment to accommodate full-size DBRY-6 splice connectors and an integrated two-way module
- Solenoid and pressure regulator are serviceable without system depressurization
- Proprietary Filter Sentry® Mechanism cleans the filter with every opening and closing cycle
- All TTS-800 Series Golf Rotors advanced features listed on **pages 208 to 211**

OPERATING SPECIFICATIONS

- Radius: 5.5 to 15.2 m
- Flow: 0.43 to 2.91 m³/hr; 7.2 to 48.5 l/min
- Pressure range: 2.8 to 4.5 bar; 280 to 450 kPa
- All TTS rotors are pressure-rated at 10 bar; 1,000 kPa
- Nozzle range: #2 to #12

OPTIONS

- C – Check-o-Matic Technology checks up to 8 m in elevation change and readily converts to normally open hydraulic with through-the-top connections
- D – Decoder Valve-in-Head Technology with all “E” specifications below*
- DD – Two-station decoder Valve-in-Head Technology with all “E” specifications below*
- E – Electric Valve-in-Head Technology with adjustable pressure regulation, on-off-auto elector, 210 mA (370 mA inrush) 50 Hz; 190 mA (350 mA inrush) 60 Hz solenoid with captive plunger and internal downstream bleed

* All DIH rotors include two 3M DBRY-6 splices for connection to the two-wire path. See **page 200** for critical recommendations on grounding DIH rotors.



GT-835

Pop-up height: 8 cm
Overall height: 30 cm
Flange diameter: 18 cm
Female inlet: 1½" (40 mm) Acme

GT-835 – SPECIFICATION BUILDER: ORDER 1 + 2 + 3 + 4

1 Model	2 Valve Options	3 Nozzle	4 Regulation
GT-835 = Full/part-circle, 50° to 360°	C = Check-o-Matic Technology* D = Decoder Valve-in-Head Technology E = Electric Valve-in-Head Technology *Converts to N.O. hydraulic Valve-in-Head Technology	6 = Installed G-835 nozzle (includes 8-nozzle rack)	P5 = 50 PSI; 3.4 bar; 340 kPa (nozzles 18 to 25) P6 = 65 PSI; 4.5 bar; 450 kPa (nozzles 18 to 25)

Example:

GT-835-6-P5 = GT-835 full/part-circle electric Valve-in-Head Technology, installed #6 nozzle, 50 PSI; 3.4 bar; 340 kPa regulation

GT-835 NOZZLE PERFORMANCE DATA*

Nozzle	Pressure		Radius m	Flow		Precip mm/hr	
	bar	kPa		m ³ /hr	l/min	■	▲
2 ● Yellow	2.8	280	5.5	0.43	7.2	14.3	16.6
	3.4	340	6.1	0.48	7.9	12.8	14.8
	4.1	410	6.7	0.55	9.1	12.1	14.0
	4.5	450	7.0	0.59	9.8	12.0	13.9
3 ● Yellow	2.8	280	7.0	0.68	11.4	13.9	16.0
	3.4	340	7.6	0.73	21.1	12.5	14.5
	4.1	410	8.2	0.80	13.2	11.7	13.6
	4.5	450	8.5	0.82	13.6	11.2	13.0
4 ● Yellow	2.8	280	7.6	0.89	14.8	15.3	17.6
	3.4	340	8.5	0.93	15.5	12.8	14.8
	4.1	410	9.1	1.00	16.7	12.0	13.8
	4.5	450	9.4	1.04	17.4	11.7	13.5
5 ● Yellow	2.8	280	8.8	1.07	17.8	13.7	15.8
	3.4	340	9.8	1.14	18.9	11.9	13.8
	4.1	410	10.1	1.20	20.1	11.9	13.7
	4.5	450	10.7	1.23	20.4	10.8	12.4
6 ● Yellow	2.8	280	9.8	1.36	22.7	14.3	16.5
	3.4	340	10.7	1.43	23.8	12.6	14.5
	4.1	410	11.3	1.50	25.0	11.8	13.6
	4.5	450	11.9	1.54	25.7	10.9	12.6
8 ● Yellow	2.8	280	11.0	1.77	29.5	14.7	17.0
	3.4	340	11.9	1.82	30.3	12.9	14.8
	4.1	410	12.8	1.89	31.4	11.5	13.3
	4.5	450	13.1	1.93	32.2	11.2	13.0
10 ● Yellow	2.8	280	11.9	2.20	36.7	15.6	18.0
	3.4	340	13.1	2.29	38.2	13.4	15.4
	4.1	410	13.7	2.34	39.0	12.4	14.4
	4.5	450	14.3	2.39	39.7	11.6	13.4
12 ● Yellow	2.8	280	13.4	2.73	45.4	15.2	17.5
	3.4	340	14.3	2.77	46.2	13.5	15.6
	4.1	410	14.6	2.84	47.3	13.3	15.3
	4.5	450	15.2	2.91	48.5	12.5	14.5

GT-835 NOZZLES



Optional Yardage Marker Colours

Extra-large snap-in marker plates are available in standard black as well as optional red, white, and blue to meet every golf course preference. Or, choose the purple plate for identification when courses are using reclaimed water.



Low-Bounce Rubber Cover Kit - PN 987200SP

Reduce the incoming bounce from balls hitting rotors that are surrounding the greens.



No-Bounce Turf Cup Kit - PN 987100SP

Eliminate errant bounces from balls hitting greens surrounding rotors with this subsurface rotor-mounting solution.

G-800 SERIES



These rotors feature convenient no-dig Total-Top-Serviceability and powerful, high-torque gear drive.

KEY BENEFITS

- Dedicated, true full-circle model distinguished by a black collar
- Exclusive PressurePort™ Technology optimizes incoming pressure at each nozzle to increase consistency and maximize distribution uniformity
- High-torque gear drive is the strongest in the industry to mitigate the challenges of debris infiltration
- Proprietary Filter Sentry® Mechanism cleans the filter with every opening and closing cycle

OPERATING SPECIFICATIONS

- Radius: 14.9 to 29.6 m
- Flow: 3.23 to 13.29 m³/hr; 53.8 to 221.4 l/min
- Pressure range: 3.4 to 6.9 bar; 340 to 690 kPa
- All TTS rotors are pressure-rated at 10 bar; 1,000 kPa
- Nozzle range: #15 to #53
 - 10 standard trajectory (22.5°)
 - 9 low-angle trajectory (15°)

OPTIONS

- C - Check-o-Matic Technology checks up to 8 m in elevation change and readily converts to normally open hydraulic with through-the-top connections
- D - Decoder Valve-in-Head Technology with all “E” specifications below*
- DD - Two-station decoder Valve-in-Head Technology with all “E” specifications below*
- E - Electric Valve-in-Head Technology with adjustable pressure regulation, on-off-auto selector, 210 mA (370 mA inrush) 50 Hz; 190 mA (350 mA inrush) 60 Hz solenoid with captive plunger and internal downstream bleed

* All DIH rotors include two 3M DBRY-6 splices for connection to the two-wire path. See **page 200** for critical recommendations on grounding DIH rotors.



G-880C

Pop-up height: 9.5 cm
Overall height: 30 cm
Flange diameter: 18 cm
Female inlet: 1½" (40 mm) Acme



G-880E

Pop-up height: 9.5 cm
Overall height: 30 cm
Flange diameter: 18 cm
Female inlet: 1½" (40 mm) Acme

G-880 - SPECIFICATION BUILDER: ORDER 1 + 2 + 3 + 4

1 Model	2 Valve Options	3 Nozzle	4 Regulation
G-880 = Full-circle	<p>C = Check-o-Matic Technology*</p> <p>D = Decoder Valve-in-Head Technology</p> <p>DD = Two-station decoder Valve-in-Head Technology</p> <p>E = Electric Valve-in-Head Technology</p> <p>*Converts to N.O. hydraulic Valve-in-Head Technology</p>	15 to 53 = Installed G-880 nozzle	<p>P5 = 50 PSI; 3.4 bar; 340 kPa (nozzles 15 to 18)</p> <p>P6 = 65 PSI; 4.5 bar; 450 kPa (nozzles 18 to 25)</p> <p>P8 = 80 PSI; 5.5 bar; 550 kPa (nozzles 25 to 53)</p>

Example:

G-880-E-33-P8 = G-880 full-circle electric Valve-in-Head Technology, installed #33 nozzle, 80 PSI; 5.5 bar; 550 kPa regulation



G-880 NOZZLE PERFORMANCE DATA*										
Nozzle Set			Pressure		Radius		Flow		Precip mm/hr	
			bar	kPa	m	m ³ /hr	l/min	■	▲	
●	○	●	3.4	344	14.9	3.23	53.8	14.5	16.7	
Tan	15	Grey	4.1	413	15.5	3.57	59.4	14.8	17.0	
803611		White	4.5	450	15.9	3.73	62.1	14.8	17.1	
803611		315317	4.8	482	16.2	3.86	64.4	14.8	17.1	
803611		315317	5.5	551	16.8	4.13	68.9	14.7	17.0	
●	○	●	3.4	344	17.1	3.91	65.1	13.4	15.5	
Tan	18	Grey	4.1	413	17.7	4.28	71.3	13.7	15.8	
803611		Orange	4.5	450	18.0	4.48	74.6	13.8	16.0	
803611		315317	4.8	482	18.3	4.54	75.7	13.6	15.7	
803611		315317	5.5	551	18.6	4.82	80.3	13.9	16.1	
●	○	●	3.4	344	17.4	4.18	69.7	13.8	16.0	
Tan	20	Grey	4.1	413	18.0	4.61	76.8	14.3	16.5	
803611		Brown	4.5	450	18.6	4.86	81.0	14.1	16.2	
803611		315317	4.8	482	19.2	4.91	81.8	13.3	15.4	
803611		315317	5.5	551	19.5	5.16	85.9	13.5	15.6	
●	○	●	3.4	344	19.2	4.91	81.8	13.3	15.4	
Tan	23	Lt. Blue	4.1	413	19.8	5.22	87.1	13.3	15.4	
803611		Green	4.5	450	20.1	5.45	90.8	13.5	15.6	
803611		315311	4.8	482	20.4	5.66	94.3	13.6	15.7	
803611		315311	5.5	551	20.7	6.04	100.7	14.1	16.2	
●	○	●	4.5	450	21.6	6.50	108.3	13.9	16.0	
Tan	25	Lt. Blue	4.8	482	22.3	6.75	112.5	13.6	15.7	
803611		Blue	5.5	551	22.6	7.19	119.8	14.1	16.3	
803611		315311	6.2	620	22.9	7.65	127.5	14.6	16.9	
803611		315311	6.9	689	23.5	8.12	135.3	14.7	17.0	
●	○	●	4.5	450	22.6	7.02	117.0	13.8	15.9	
Tan	33	Lt. Blue	4.8	482	22.9	7.27	121.1	13.9	16.1	
803611		Grey	5.5	551	23.5	7.77	129.5	14.1	16.3	
803611		315311	6.2	620	24.1	8.22	137.0	14.2	16.4	
803611		315311	6.9	689	24.7	8.68	144.6	14.2	16.4	
●	○	●	4.5	450	23.5	7.97	132.9	14.5	16.7	
Tan	38	Lt. Blue	4.8	482	24.1	8.31	138.5	14.3	16.6	
803611		Red	5.5	551	25.0	8.84	147.3	14.1	16.3	
803611		315311	6.2	620	25.6	9.38	156.3	14.3	16.5	
803611		315311	6.9	689	26.5	9.90	165.0	14.1	16.3	
●	○	●	-	-	-	-	-	-	-	
Tan	43	Blue	4.8	482	25.3	9.38	156.3	14.7	16.9	
803611		Dk. Brown	5.5	551	25.9	9.90	165.0	14.8	17.0	
803611		315300	6.2	620	26.5	10.52	175.3	15.0	17.3	
803611		315300	6.9	689	27.1	11.09	184.7	15.1	17.4	
●	○	●	-	-	-	-	-	-	-	
Dk. Brown	48	Dk. Blue	4.8	482	27.4	10.65	177.5	14.2	16.3	
803610		Dk. Green	5.5	551	28.0	11.11	185.1	14.1	16.3	
803610		833500	6.2	620	28.7	11.46	191.0	14.0	16.1	
803610		833500	6.9	689	29.3	12.15	202.5	14.2	16.4	
●	○	●	-	-	-	-	-	-	-	
Dk. Brown	53	Dk. Blue	4.8	482	27.7	11.31	188.5	14.7	17.0	
803610		Dk. Blue	5.5	551	28.3	11.86	197.7	14.8	17.0	
803610		833500	6.2	620	29.0	12.61	210.1	15.0	17.4	
803610		833500	6.9	689	29.6	13.29	221.4	15.2	17.6	

* Preliminary performance data. Complies to ASAE standard. All precipitation rates calculated for 360° operation. All triangular rates are equilateral. To calculate precipitation rates for 180° operation, multiply by 2.

G-880 STANDARD NOZZLES

G-880 LOW-ANGLE NOZZLES**



** Low-angle nozzles reduce the radius by 15%.



TTS Means Convenience and Versatility

With TTS, every serviceable component of the rotor can be easily accessed anytime with no servicing mess.

G-800 SERIES



These rotors feature convenient no-dig Total-Top-Serviceability and powerful, high-torque gear drive.

KEY BENEFITS

- Adjustable model distinguished by a grey collar that comes factory set in a true full-circle configuration
- Exclusive PressurePort™ Technology optimizes incoming pressure at each nozzle to increase consistency and maximize distribution uniformity
- High-torque gear drive is the strongest in the industry to mitigate the challenges of debris infiltration
- Proprietary Filter Sentry® Mechanism cleans the filter with every opening and closing cycle

OPERATING SPECIFICATIONS

- Radius: 14.9 to 29.6 m
- Flow: 3.23 to 13.29 m³/hr; 53.8 to 221.4 l/min
- Pressure range: 3.4 to 6.9 bar; 340 to 690 kPa
- All TTS rotors are pressure-rated at 10 bar; 1,000 kPa
- Nozzle range: #15 to #53
 - 10 standard trajectory (22.5°)
 - 9 low-angle trajectory (15°)

OPTIONS

- C - Check-o-Matic Technology checks up to 8 m in elevation change and readily converts to normally open hydraulic with through-the-top connections
- D - Decoder Valve-in-Head Technology with all “E” specifications below*
- DD - Two-station decoder Valve-in-Head Technology with all “E” specifications below*
- E - Electric Valve-in-Head Technology with adjustable pressure regulation, on-off-auto selector, 210 mA (370 mA inrush) 50 Hz; 190 mA (350 mA inrush) 60 Hz solenoid with captive plunger and internal downstream bleed

* All DIH rotors include two 3M DBRY-6 splices for connection to the two-wire path. See **page 200** for critical recommendations on grounding DIH rotors.



G-884C

Pop-up height: 9.5 cm
Overall height: 30 cm
Flange diameter: 18 cm
Female inlet: 1½" (40 mm) Acme



G-884E

Pop-up height: 9.5 cm
Overall height: 30 cm
Flange diameter: 18 cm
Female inlet: 1½" (40 mm) Acme

G-884 - SPECIFICATION BUILDER: ORDER 1 + 2 + 3 + 4

1 Model	2 Valve Options	3 Nozzle	4 Regulation
G-884 = Full-circle (convertible to forward-facing adjustable arc rotor)	C = Check-o-Matic Technology* D = Decoder Valve-in-Head Technology DD = Two-station decoder Valve-in-Head Technology E = Electric Valve-in-Head Technology *Converts to N.O. hydraulic Valve-in-Head Technology	15 to 53 = Installed G-880 nozzle	P5 = 50 PSI; 3.4 bar; 340 kPa (nozzles 15 to 18) P6 = 65 PSI; 4.5 bar; 450 kPa (nozzles 18 to 25) P8 = 80 PSI; 5.5 bar; 550 kPa (nozzles 25 to 53)

Example:

G-884-E-33-P8 = G-884 full-circle electric Valve-in-Head Technology, installed #33 nozzle, 80 PSI; 5.5 bar; 550 kPa regulation

G-884 NOZZLE PERFORMANCE DATA*										
Nozzle Set			Pressure		Radius		Flow		Precip mm/hr	
			bar	kPa	m	m ³ /hr	l/min	■	▲	
●	○	●	3.4	344	14.9	3.23	53.8	14.5	16.7	
Tan	15	Grey	4.1	413	15.5	3.57	59.4	14.8	17.0	
803611		White	4.5	450	15.9	3.73	62.1	14.8	17.1	
803611		White	4.8	482	16.2	3.86	64.4	14.8	17.1	
803611		White	5.5	551	16.8	4.13	68.9	14.7	17.0	
●	○	●	3.4	344	17.1	3.91	65.1	13.4	15.5	
Tan	18	Grey	4.1	413	17.7	4.28	71.3	13.7	15.8	
803611		Orange	4.5	450	18.0	4.48	74.6	13.8	16.0	
803611		Orange	4.8	482	18.3	4.54	75.7	13.6	15.7	
803611		Orange	5.5	551	18.6	4.82	80.3	13.9	16.1	
●	○	●	3.4	344	17.4	4.18	69.7	13.8	16.0	
Tan	20	Grey	4.1	413	18.0	4.61	76.8	14.3	16.5	
803611		Brown	4.5	450	18.6	4.86	81.0	14.1	16.2	
803611		Brown	4.8	482	19.2	4.91	81.8	13.3	15.4	
803611		Brown	5.5	551	19.5	5.16	85.9	13.5	15.6	
●	○	●	3.4	344	19.2	4.91	81.8	13.3	15.4	
Tan	23	Lt. Blue	4.1	413	19.8	5.22	87.1	13.3	15.4	
803611		Green	4.5	450	20.1	5.45	90.8	13.5	15.6	
803611		Green	4.8	482	20.4	5.66	94.3	13.6	15.7	
803611		Green	5.5	551	20.7	6.04	100.7	14.1	16.2	
●	○	●	4.5	450	21.6	6.50	108.3	13.9	16.0	
Tan	25	Lt. Blue	4.8	482	22.3	6.75	112.5	13.6	15.7	
803611		Blue	5.5	551	22.6	7.19	119.8	14.1	16.3	
803611		Blue	6.2	620	22.9	7.65	127.5	14.6	16.9	
803611		Blue	6.9	689	23.5	8.12	135.3	14.7	17.0	
●	○	●	4.5	450	22.6	7.02	117.0	13.8	15.9	
Tan	33	Lt. Blue	4.8	482	22.9	7.27	121.1	13.9	16.1	
803611		Grey	5.5	551	23.5	7.77	129.5	14.1	16.3	
803611		Grey	6.2	620	24.1	8.22	137.0	14.2	16.4	
803611		Grey	6.9	689	24.7	8.68	144.6	14.2	16.4	
●	○	●	4.5	450	23.5	7.97	132.9	14.5	16.7	
Tan	38	Lt. Blue	4.8	482	24.1	8.31	138.5	14.3	16.6	
803611		Red	5.5	551	25.0	8.84	147.3	14.1	16.3	
803611		Red	6.2	620	25.6	9.38	156.3	14.3	16.5	
803611		Red	6.9	689	26.5	9.90	165.0	14.1	16.3	
●	○	●	-	-	-	-	-	-	-	
Tan	43	Blue	4.8	482	25.3	9.38	156.3	14.7	16.9	
803611		Dk. Brown	5.5	551	25.9	9.90	165.0	14.8	17.0	
803611		Dk. Brown	6.2	620	26.5	10.52	175.3	15.0	17.3	
803611		Dk. Brown	6.9	689	27.1	11.09	184.7	15.1	17.4	
●	○	●	-	-	-	-	-	-	-	
Dk. Brown	48	Dk. Blue	4.8	482	27.4	10.65	177.5	14.2	16.3	
803610		Dk. Green	5.5	551	28.0	11.11	185.1	14.1	16.3	
803610		Dk. Green	6.2	620	28.7	11.46	191.0	14.0	16.1	
803610		Dk. Green	6.9	689	29.3	12.15	202.5	14.2	16.4	
●	○	●	-	-	-	-	-	-	-	
Dk. Brown	53	Dk. Blue	4.8	482	27.7	11.31	188.5	14.7	17.0	
803610		Dk. Blue	5.5	551	28.3	11.86	197.7	14.8	17.0	
803610		Dk. Blue	6.2	620	29.0	12.61	210.1	15.0	17.4	
803610		Dk. Blue	6.9	689	29.6	13.29	221.4	15.2	17.6	

* Complies to ASAE standard. All precipitation rates calculated for 360° operation. All triangular rates are equilateral. To calculate precipitation rates for 180° operation, multiply by 2.

G-884 STANDARD NOZZLES

G-884 LOW-ANGLE NOZZLES**



** Low-angle nozzles reduce radius by 15%



G-885 Decoder-in-Head TTS Rotor

TTS Flange Compartment

All TTS rotors include ample room for solenoid splice connections and a two-way module when needed.

G-800 SERIES



These rotors feature convenient no-dig Total-Top-Serviceability and powerful, high-torque gear drive.

KEY BENEFITS

- Adjustable model distinguished by a grey collar that comes factory set in a part-circle configuration (60° to 360°)
- Exclusive PressurePort™ Technology optimizes incoming pressure at each nozzle to increase consistency and maximize distribution uniformity.
- High-torque gear drive is the strongest in the industry to mitigate the challenges of debris infiltration
- Proprietary Filter Sentry® Mechanism cleans the filter with every opening and closing cycle

OPERATING SPECIFICATIONS

- Radius: 11.3 to 28.7 m
- Flow: 2.02 to 13.54 m³/hr; 33.7 to 225.6 l/min
- Pressure range: 3.4 to 6.9 bar; 340 to 690 kPa
- All TTS rotors are pressure-rated at 10 bar; 1,000 kPa
- Nozzle range: #10 to #53
 - 12 standard trajectory (22.5°)
 - 9 low-angle trajectory (15°)

OPTIONS

- C - Check-o-Matic Technology checks up to 8 m in elevation change and readily converts to normally open hydraulic with through-the-top connections
- D - Decoder Valve-in-Head Technology with all “E” specifications below*
- DD - Two-station decoder Valve-in-Head Technology with all “E” specifications below*
- E - Electric Valve-in-Head Technology with adjustable pressure regulation, on-off-auto selector, 210 mA (370 mA inrush) 50 Hz; 190 mA (350 mA inrush) 60 Hz solenoid with captive plunger and internal downstream bleed

* All DIH rotors include two 3M DBRY-6 splices for connection to the two-wire path. See **page 200** for critical recommendations on grounding DIH rotors.



G-885C

Pop-up height: 9.5 cm
Overall height: 30 cm
Flange diameter: 18 cm
Female inlet: 1/2" (40 mm) Acme



G-885E

Pop-up height: 9.5 cm
Overall height: 30 cm
Flange diameter: 18 cm
Female inlet: 1/2" (40 mm) Acme

G-885 - SPECIFICATION BUILDER: ORDER 1 + 2 + 3 + 4

1 Model	2 Valve Options	3 Nozzle	4 Regulation
G-885 = Full/part-circle 60°-360° arc range	C = Check-o-Matic Technology* D = Decoder Valve-in-Head Technology DD = Two-station decoder Valve-in-Head Technology E = Electric Valve-in-Head Technology *Converts to N.O. hydraulic Valve-in-Head Technology	10 to 53 = Installed G-885 nozzle	P5 = 50 PSI; 3.4 bar; 340 kPa (nozzles 10 to 18) P6 = 65 PSI; 4.5 bar; 450 kPa (nozzles 18 to 25) P8 = 80 PSI; 5.5 bar; 550 kPa (nozzles 25 to 53)

Example:

G-885-E-33-P8 = G-885 full/part-circle electric Valve-in-Head Technology, installed #33 nozzle, 80 PSI; 5.5 bar; 550 kPa regulation



G-885 NOZZLE PERFORMANCE DATA*									
Nozzle Set			Pressure		Radius	Flow		Precip mm/hr	
			bar	kPa	m	m ³ /hr	l/min	■	▲
Orange 803603 ●	10	Dk. Green 315312	3.4	344	11.3	2.02	33.7	15.9	18.4
			4.1	413	11.9	2.23	37.1	15.8	18.2
			4.5	450	12.5	2.32	38.6	14.8	17.1
		Lt. Green	-	-	-	-	-	-	-
Orange 803603 ●	13	White 315314	3.4	344	14.3	2.59	43.2	12.6	14.6
			4.1	413	14.6	2.79	46.6	13.1	15.1
			4.5	450	14.9	2.93	48.8	13.1	15.2
		Lt. Blue	-	-	-	-	-	-	-
Orange 803603 ●	15	White 315314	3.4	344	15.9	2.93	48.8	11.7	13.5
			4.1	413	15.9	3.29	54.9	13.1	15.1
			4.5	450	16.2	3.38	56.4	13.0	15.0
		White	4.8	482	16.2	3.52	58.7	13.5	15.6
Orange 803603 ●	18	Lt. Green 315313	3.4	344	17.4	3.77	62.8	12.5	14.4
			4.1	413	17.7	4.04	67.4	12.9	14.9
			4.5	450	18.0	4.23	70.4	13.1	15.1
		Orange	4.8	482	18.3	4.41	73.4	13.2	15.2
Orange 803603 ●	20	Lt. Green 315313	3.4	344	18.0	4.07	67.8	12.6	14.5
			4.1	413	18.6	4.43	73.8	12.8	14.8
			4.5	450	18.9	4.50	75.0	12.6	14.5
		Tan	4.8	482	19.2	4.68	78.0	12.7	14.7
Orange 803603 ●	23	Lt. Green 315313	3.4	344	19.8	4.59	76.5	11.7	13.5
			4.1	413	20.1	5.02	83.7	12.4	14.3
			4.5	450	20.4	5.43	90.5	13.0	15.0
		Green	4.8	482	20.4	5.50	91.6	13.2	15.2
Red 803602 ●	25	Green 315310	4.5	450	21.6	6.43	107.1	13.7	15.8
			4.8	482	21.9	6.66	110.9	13.8	16.0
			5.5	551	22.3	7.16	119.2	14.5	16.7
		Blue	6.2	620	22.6	7.59	126.4	14.9	17.2
Red 803602 ●	33	Green 315310	4.5	450	21.9	6.95	115.8	14.4	16.7
			4.8	482	22.3	7.18	119.6	14.5	16.7
			5.5	551	22.9	7.70	128.3	14.7	17.0
		Grey	6.2	620	23.5	8.13	135.5	14.8	17.0
Red 803602 ●	38	Green 315310	4.5	450	23.2	7.93	132.1	14.8	17.1
			4.8	482	23.8	8.22	137.0	14.5	16.8
			5.5	551	24.4	8.88	148.0	14.9	17.2
		Red	6.2	620	25.0	9.36	156.0	15.0	17.3
Red 803602 ●	43	Green 315310	-	-	-	-	-	-	-
			4.8	482	24.7	9.36	156.0	15.4	17.7
			5.5	551	25.3	9.88	164.7	15.4	17.8
		Dk. Brown	6.2	620	26.2	10.49	174.9	15.3	17.6
Dk. Red 803601 ●	48	Dk. Green 315312	6.9	689	27.1	11.06	184.3	15.0	17.4
			-	-	-	-	-	-	-
			4.8	482	25.3	10.52	175.3	16.4	19.0
		Dk. Green	5.5	551	25.9	10.99	183.2	16.4	18.9
Dk. Red 803601 ●	53	Dk. Green 315312	6.2	620	27.1	11.74	195.7	16.0	18.4
			6.9	689	27.7	12.38	206.3	16.1	18.6
			-	-	-	-	-	-	-
		Dk. Green	4.8	482	26.5	11.52	191.9	16.4	18.9
Dk. Red 803601 ●	53	Dk. Green 315312	5.5	551	27.1	12.06	201.0	16.4	18.9
			6.2	620	28.0	12.81	213.5	16.3	18.8
		Dk. Blue	6.9	689	28.7	13.54	225.6	16.5	19.0

● = Nozzle plug P/N 315300 installed in the back side of the nozzle housing.

* Complies to ASAE standard. All precipitation rates calculated for 360° operation. All triangular rates are equilateral. To calculate precipitation rates for 180° operation, multiply by 2.

G-885 STANDARD NOZZLES

G-885 LOW-ANGLE NOZZLES**



** Low-angle nozzles reduce the radius by 15%.



Contour Back-Nozzle Capabilities

Whether you want a little extra green behind your adjustable arc TTS rotors or a more modeled look to your fairway's hard edges, contour back-nozzles are here to make your vision a reality. Choose from four short-range or four mid-range nozzles to suit your needs.

CONTOUR BACK-NOZZLE PERFORMANCE DATA

P/N	Colour	Profile	4.5 Bar		5.5 Bar	
			Metres	L/M	Metres	L/M
803604	Peach		7.6	12.9	8.2	14.8
803603	Orange		8.5	14.4	8.8	15.9
803602	Red		9.4	15.9	10.1	17.0
803601	Dk. Red		10.4	17.4	11.0	18.5
315314	White		11.3	10.6	11.6	11.0
315313	Lt. Green		12.8	16.3	13.4	17.8
315310	Green		14.0	19.7	14.6	21.6
315312	Dk. Green		14.9	29.9	15.5	33.3

GT-885/G-885 CONTOUR BACK-NOZZLES



QuickSet-360 with Ratcheting Riser

Setting up your adjustable arc TTS rotor is fast and simple. The integrated ratcheting mechanism allows a simple twist of the riser to align the right-side reversing point. These rotors are also easily convertible to a true non-reversing full-circle with our exclusive QuickSet-360 feature.

G-800 SERIES



These rotors feature convenient no-dig Total-Top-Serviceability and shorter-radius, lower-flow internals.

KEY BENEFITS

- Adjustable, shorter radius model (50° to 360°)
- Proprietary Filter Sentry® Mechanism cleans the filter with every opening and closing cycle

OPERATING SPECIFICATIONS

- Radius: 5.5 to 15.2 m
- Flow: 0.43 to 2.91 m³/hr; 7.2 to 48.5 l/min
- Pressure range: 2.8 to 4.5 bar; 280 to 450 kPa
- All TTS rotors are pressure-rated at 10 bar; 1,000 kPa
- Nozzle range: #2 to #12

OPTIONS

- C - Check-o-Matic Technology checks up to 8 m in elevation change and readily converts to normally open hydraulic with through-the-top connections
- D - Decoder Valve-in-Head Technology with all "E" specifications below*
- DD - Two-station decoder Valve-in-Head Technology with all "E" specifications below*
- E - Electric Valve-in-Head Technology with adjustable pressure regulation, on-off-auto selector, 210 mA (370 mA inrush) 50 Hz; 190 mA (350 mA inrush) 60 Hz solenoid with captive plunger and internal downstream bleed

* All DIH rotors include two 3M DBRY-6 splices for connection to the two-wire path. See **page 200** for critical recommendations on grounding DIH rotors.



G-835C

Pop-up height: 8 cm
Overall height: 30 cm
Flange diameter: 18 cm
Female inlet: 1½" (40 mm) Acme



G-835E

Pop-up height: 8 cm
Overall height: 30 cm
Flange diameter: 18 cm
Female inlet: 1½" (40 mm) Acme

G-835 - SPECIFICATION BUILDER: ORDER 1+ 2 + 3 + 4

1 Model	2 Valve Options	3 Nozzle	4 Regulation
G-835 = Full/part-circle, 50° to 360°	<p>C = Check-o-Matic Technology *</p> <p>D = Decoder Valve-in-Head Technology</p> <p>E = Electric Valve-in-Head Technology</p> <p>*Converts to N.O. hydraulic Valve-in-Head Technology</p>	6 = Installed G-835 nozzle (includes 8-nozzle rack)	<p>P5 = 50 PSI; 3.4 bar; 340 kPa</p> <p>P6 = 65 PSI; 4.5 bar; 450 kPa</p>

Example:

G-835E-6-P6= G-835 full/part-circle electric Valve-in-Head Technology, installed #6 nozzle, 50 PSI; 3.4 bar; 340 kPa regulation

G-835 NOZZLE PERFORMANCE DATA							
Nozzle	Pressure		Radius m	Flow		Precip mm/hr	
	bar	kPa		m ³ /hr	l/min	■	▲
2 ● Yellow	2.8	280	5.5	0.43	7.2	14.3	16.6
	3.4	340	6.1	0.48	7.9	12.8	14.8
	4.1	410	6.7	0.55	9.1	12.1	14.0
	4.5	450	7.0	0.59	9.8	12.0	13.9
3 ● Yellow	2.8	280	7.0	0.68	11.4	13.9	16.0
	3.4	340	7.6	0.73	21.1	12.5	14.5
	4.1	410	8.2	0.80	13.2	11.7	13.6
	4.5	450	8.5	0.82	13.6	11.2	13.0
4 ● Yellow	2.8	280	7.6	0.89	14.8	15.3	17.6
	3.4	340	8.5	0.93	15.5	12.8	14.8
	4.1	410	9.1	1.00	16.7	12.0	13.8
	4.5	450	9.4	1.04	17.4	11.7	13.5
5 ● Yellow	2.8	280	8.8	1.07	17.8	13.7	15.8
	3.4	340	9.8	1.14	18.9	11.9	13.8
	4.1	410	10.1	1.20	20.1	11.9	13.7
	4.5	450	10.7	1.23	20.4	10.8	12.4
6 ● Yellow	2.8	280	9.8	1.36	22.7	14.3	16.5
	3.4	340	10.7	1.43	23.8	12.6	14.5
	4.1	410	11.3	1.50	25.0	11.8	13.6
	4.5	450	11.9	1.54	25.7	10.9	12.6
8 ● Yellow	2.8	280	11.0	1.77	29.5	14.7	17.0
	3.4	340	11.9	1.82	30.3	12.9	14.8
	4.1	410	12.8	1.89	31.4	11.5	13.3
	4.5	450	13.1	1.93	32.2	11.2	13.0
10 ● Yellow	2.8	280	11.9	2.20	36.7	15.6	18.0
	3.4	340	13.1	2.29	38.2	13.4	15.4
	4.1	410	13.7	2.34	39.0	12.4	14.4
	4.5	450	14.3	2.39	39.7	11.6	13.4
12 ● Yellow	2.8	280	13.4	2.73	45.4	15.2	17.5
	3.4	340	14.3	2.77	46.2	13.5	15.6
	4.1	410	14.6	2.84	47.3	13.3	15.3
	4.5	450	15.2	2.91	48.5	12.5	14.5

G-835 NOZZLES



QuickSet-360

With Hunter's QuickCheck Arc Mechanism and patented QuickSet-360 non-reversing full-circle feature in a variable arc rotor, adjustments are fast, easy, and more flexible than ever before. Now available on all TTS-800 Series, G-800 Series and B Series adjustable arc rotors.

B SERIES



These highly efficient block rotors have a powerful gear drive backed by the reliability synonymous with the Hunter name.

KEY BENEFITS

- Dedicated, true full-circle model distinguished by a black collar
- Exclusive PressurePort™ Technology optimizes incoming pressure at each nozzle to increase consistency and maximize distribution uniformity
- High-torque gear drive is the strongest in the industry to mitigate the challenges of debris infiltration

OPERATING SPECIFICATIONS

- G-80-B
 - Radius: 14.9 to 29.6 m
 - Flow: 3.23 to 13.29 m³/hr; 53.8 to 221.4 l/min
 - Pressure range: 3.4 to 6.9 bar; 340 to 690 kPa
- All B Series Golf Rotors are pressure-rated at 10 bar; 1,000 kPa
- Check height up to 2 m in elevation change
- Nozzle range: #15 to #53
 - 10 standard trajectory (22.5°)
 - 9 low-angle trajectory (15°)



G-80-B

Pop-up height: 9.5 cm
 Overall height: 24.5 cm
 Flange diameter: 13.7 cm
 Female inlet: 1¼" (32 mm) Acme

G-80-B – SPECIFICATION BUILDER: ORDER 1 + 2 + 3 + 4

1 Model	2 Valve Options	3 Nozzle	4 Options*
G-80 = Full-circle	B = Block rotor with check valve	15 to 53 = Installed G80 nozzle* *SSU = #18, #25, or #48	S = SSU* *Standard stocking unit

Example:
 G-80-B-25-S = G-80 full-circle block rotor, installed #25 nozzle, standard stocking unit model

G-80-B NOZZLE PERFORMANCE DATA										
Nozzle Set			Pressure		Radius		Flow		Precip mm/hr	
			bar	kPa	m	m ³ /hr	l/min	■	▲	
●	○	●	3.4	344	14.9	3.23	53.8	14.5	16.7	
Tan	15	Grey	4.1	413	15.5	3.57	59.4	14.8	17.0	
803611		White	4.5	450	15.9	3.73	62.1	14.8	17.1	
803611		White	4.8	482	16.2	3.86	64.4	14.8	17.1	
803611		White	5.5	551	16.8	4.13	68.9	14.7	17.0	
●	○	●	3.4	344	17.1	3.91	65.1	13.4	15.5	
Tan	18	Grey	4.1	413	17.7	4.28	71.3	13.7	15.8	
803611		Orange	4.5	450	18.0	4.48	74.6	13.8	16.0	
803611		Orange	4.8	482	18.3	4.54	75.7	13.6	15.7	
803611		Orange	5.5	551	18.6	4.82	80.3	13.9	16.1	
●	○	●	3.4	344	17.4	4.18	69.7	13.8	16.0	
Tan	20	Grey	4.1	413	18.0	4.61	76.8	14.3	16.5	
803611		Brown	4.5	450	18.6	4.86	81.0	14.1	16.2	
803611		Brown	4.8	482	19.2	4.91	81.8	13.3	15.4	
803611		Brown	5.5	551	19.5	5.16	85.9	13.5	15.6	
●	○	●	3.4	344	19.2	4.91	81.8	13.3	15.4	
Tan	23	Lt. Blue	4.1	413	19.8	5.22	87.1	13.3	15.4	
803611		Green	4.5	450	20.1	5.45	90.8	13.5	15.6	
803611		Green	4.8	482	20.4	5.66	94.3	13.6	15.7	
803611		Green	5.5	551	20.7	6.04	100.7	14.1	16.2	
●	○	●	4.5	450	21.6	6.50	108.3	13.9	16.0	
Tan	25	Lt. Blue	4.8	482	22.3	6.75	112.5	13.6	15.7	
803611		Blue	5.5	551	22.6	7.19	119.8	14.1	16.3	
803611		Blue	6.2	620	22.9	7.65	127.5	14.6	16.9	
803611		Blue	6.9	689	23.5	8.12	135.3	14.7	17.0	
●	○	●	4.5	450	22.6	7.02	117.0	13.8	15.9	
Tan	33	Lt. Blue	4.8	482	22.9	7.27	121.1	13.9	16.1	
803611		Grey	5.5	551	23.5	7.77	129.5	14.1	16.3	
803611		Grey	6.2	620	24.1	8.22	137.0	14.2	16.4	
803611		Grey	6.9	689	24.7	8.68	144.6	14.2	16.4	
●	○	●	4.5	450	23.5	7.97	132.9	14.5	16.7	
Tan	38	Lt. Blue	4.8	482	24.1	8.31	138.5	14.3	16.6	
803611		Red	5.5	551	25.0	8.84	147.3	14.1	16.3	
803611		Red	6.2	620	25.6	9.38	156.3	14.3	16.5	
803611		Red	6.9	689	26.5	9.90	165.0	14.1	16.3	
●	○	●	-	-	-	-	-	-	-	
Tan	43	Blue	4.8	482	25.3	9.38	156.3	14.7	16.9	
803611		Dk. Brown	5.5	551	25.9	9.90	165.0	14.8	17.0	
803611		Dk. Brown	6.2	620	26.5	10.52	175.3	15.0	17.3	
803611		Dk. Brown	6.9	689	27.1	11.09	184.7	15.1	17.4	
●	○	●	-	-	-	-	-	-	-	
Dk. Brown	48	Dk. Blue	4.8	482	27.4	10.65	177.5	14.2	16.3	
803610		Dk. Green	5.5	551	28.0	11.11	185.1	14.1	16.3	
803610		Dk. Green	6.2	620	28.7	11.46	191.0	14.0	16.1	
803610		Dk. Green	6.9	689	29.3	12.15	202.5	14.2	16.4	
●	○	●	-	-	-	-	-	-	-	
Dk. Brown	53	Dk. Blue	4.8	482	27.7	11.31	188.5	14.7	17.0	
803610		Dk. Blue	5.5	551	28.3	11.86	197.7	14.8	17.0	
803610		Dk. Blue	6.2	620	29.0	12.61	210.1	15.0	17.4	
803610		Dk. Blue	6.9	689	29.6	13.29	221.4	15.2	17.6	

G-80-B NOZZLES



LOW-ANGLE NOZZLES**



** Low-angle nozzles reduce the radius by 15%.

* Complies to ASAE standard. All precipitation rates calculated for 360° operation. All triangular rates are equilateral.

B SERIES



These highly efficient block rotors have a powerful gear drive backed by the reliability synonymous with the Hunter name.

KEY BENEFITS

- G-84-B
 - Adjustable model distinguished by a grey collar that comes factory set in a true full-circle configuration
 - Exclusive PressurePort™ Technology optimizes incoming pressure at each nozzle to increase consistency and maximize distribution uniformity
 - High-torque gear drive is the strongest in the industry to mitigate the challenges of debris infiltration
- G-85-B
 - Adjustable model distinguished by a grey collar that comes factory set in a part-circle configuration (60° to 360°)
 - Exclusive PressurePort™ Technology optimizes incoming pressure at each nozzle to increase consistency and maximize distribution uniformity
 - High-torque gear drive is the strongest in the industry to mitigate the challenges of debris infiltration

OPERATING SPECIFICATIONS

- G-84-B
 - Radius: 14.9 to 29.6 m
 - Flow: 3.23 to 13.29 m³/hr; 53.8 to 221.4 l/min
 - Pressure range: 3.4 to 6.9 bar; 340 to 690 kPa
 - Check height up to 2 m in elevation change
 - Nozzle range: #15 to #53
 - 10 standard trajectory (22.5°)
 - 9 low-angle trajectory (15°)
- G-85-B
 - Radius: 11.3 to 28.7 m
 - Flow: 2.02 to 13.54 m³/hr; 33.7 to 225.6 l/min
 - Pressure range: 3.4 to 6.9 bar; 340 to 690 kPa
 - Check height up to 2 m in elevation change
 - Nozzle range: #10 to #53
 - 12 standard trajectory (22.5°)
 - 9 low-angle trajectory (15°)
- All B Series Golf Rotors are pressure-rated at 10 bar; 1,000 kPa



G-84-B

Pop-up height: 9.5 cm
Overall height: 24.5 cm
Flange diameter: 13.7 cm
Female inlet: 1/4" (30 mm) Acme



G-85-B

Pop-up height: 9.5 cm
Overall height: 24.5 cm
Flange diameter: 13.7 cm
Female inlet: 1/4" (30 mm) Acme

G-84-B & G-85-B - SPECIFICATION BUILDER: ORDER 1 + 2 + 3 + 4

1 Model	2 Valve Options	3 Nozzle	4 Options*
G-84 = Full-circle	B = Block rotor with check valve	15 to 53 = Installed G84 nozzle* *SSU = #18, #25, or #48	S = SSU* *Standard stocking unit
G-85 = Full/part-circle, 60°-360°	B = Block rotor with check valve	10 to 53 = Installed G85 nozzle** **SSU = #18, #25, or #48	S = SSU* *Standard stocking unit

Example:

G-85-B-25-S = G-85 part-circle block rotor, installed #25 nozzle, standard stocking unit model

G-84-B NOZZLE PERFORMANCE DATA*

Nozzle Set			Pressure		Radius	Flow		Precip mm/hr	
Nozzle Color	Nozzle Size	Nozzle Plug Color	bar	kPa	m	m ³ /hr	l/min	■	▲
			15		3.4 344 14.9 3.23 53.8 14.5 16.7	4.1 413 15.5 3.57 59.4 14.8 17.0	4.5 450 15.9 3.73 62.1 14.8 17.1	4.8 482 16.2 3.86 64.4 14.8 17.1	5.5 551 16.8 4.13 68.9 14.7 17.0
18		3.4 344 17.1 3.91 65.1 13.4 15.5	4.1 413 17.7 4.28 71.3 13.7 15.8	4.5 450 18.0 4.48 74.6 13.8 16.0	4.8 482 18.3 4.54 75.7 13.6 15.7	5.5 551 18.6 4.82 80.3 13.9 16.1			
20		3.4 344 17.4 4.18 69.7 13.8 16.0	4.1 413 18.0 4.61 76.8 14.3 16.5	4.5 450 18.6 4.86 81.0 14.1 16.2	4.8 482 19.2 4.91 81.8 13.3 15.4	5.5 551 19.5 5.16 85.9 13.5 15.6			
23		3.4 344 19.2 4.91 81.8 13.3 15.4	4.1 413 19.8 5.22 87.1 13.3 15.4	4.5 450 20.1 5.45 90.8 13.5 15.6	4.8 482 20.4 5.66 94.3 13.6 15.7	5.5 551 20.7 6.04 100.7 14.1 16.2			
25		4.5 450 21.6 6.50 108.3 13.9 16.0	4.8 482 22.3 6.75 112.5 13.6 15.7	5.5 551 22.6 7.19 119.8 14.1 16.3	6.2 620 22.9 7.65 127.5 14.6 16.9	6.9 689 23.5 8.12 135.3 14.7 17.0			
33		4.5 450 22.6 7.02 117.0 13.8 15.9	4.8 482 22.9 7.27 121.1 13.9 16.1	5.5 551 23.5 7.77 129.5 14.1 16.3	6.2 620 24.1 8.22 137.0 14.2 16.4	6.9 689 24.7 8.68 144.6 14.2 16.4			
38		4.5 450 23.5 7.97 132.9 14.5 16.7	4.8 482 24.1 8.31 138.5 14.3 16.6	5.5 551 25.0 8.84 147.3 14.1 16.3	6.2 620 25.6 9.38 156.3 14.3 16.5	6.9 689 26.5 9.90 165.0 14.1 16.3			
43		- - - - - - - -	4.8 482 25.3 9.38 156.3 14.7 16.9	5.5 551 25.9 9.90 165.0 14.8 17.0	6.2 620 26.5 10.52 175.3 15.0 17.3	6.9 689 27.1 11.09 184.7 15.1 17.4			
48		- - - - - - - -	4.8 482 27.4 10.65 177.5 14.2 16.3	5.5 551 28.0 11.11 185.1 14.1 16.3	6.2 620 28.7 11.46 191.0 14.0 16.1	6.9 689 29.3 12.15 202.5 14.2 16.4			
53		- - - - - - - -	4.8 482 27.7 11.31 188.5 14.7 17.0	5.5 551 28.3 11.86 197.7 14.8 17.0	6.2 620 29.0 12.61 210.1 15.0 17.4	6.9 689 29.6 13.29 221.4 15.2 17.6			

G-84-B NOZZLES



G-85-B NOZZLES



LOW-ANGLE NOZZLES**



** Low-angle nozzles reduce the radius by 15%.

G-85-B NOZZLE PERFORMANCE DATA

Nozzle Set			Pressure		Radius	Flow		Precip mm/hr	
Nozzle Color	Nozzle Size	Nozzle Plug Color	bar	kPa	m	m ³ /hr	l/min	■	▲
			10		3.4 344 11.3 2.02 33.7 15.9 18.4	4.1 413 11.9 2.23 37.1 15.8 18.2	4.5 450 12.5 2.32 38.6 14.8 17.1	- - - - - - - -	
13		3.4 344 14.3 2.59 43.2 12.6 14.6	4.1 413 14.6 2.79 46.6 13.1 15.1	4.5 450 14.9 2.93 48.8 13.1 15.2	- - - - - - - -				
15		3.4 344 15.9 2.93 48.8 11.7 13.5	4.1 413 15.9 3.29 54.9 13.1 15.1	4.5 450 16.2 3.38 56.4 13.0 15.0	4.8 482 16.2 3.52 58.7 13.5 15.6	5.5 551 16.5 3.75 62.5 13.8 16.0			
18		3.4 344 17.4 3.77 62.8 12.5 14.4	4.1 413 17.7 4.04 67.4 12.9 14.9	4.5 450 18.0 4.23 70.4 13.1 15.1	4.8 482 18.3 4.41 73.4 13.2 15.2	5.5 551 18.6 4.66 77.6 13.5 15.6			
20		3.4 344 18.0 4.07 67.8 12.6 14.5	4.1 413 18.6 4.43 73.8 12.8 14.8	4.5 450 18.9 4.50 75.0 12.6 14.5	4.8 482 19.2 4.68 78.0 12.7 14.7	5.5 551 19.5 5.02 83.7 13.2 15.2			
23		3.4 344 19.8 4.59 76.5 11.7 13.5	4.1 413 20.1 5.02 83.7 12.4 14.3	4.5 450 20.4 5.43 90.5 13.0 15.0	4.8 482 20.4 5.50 91.6 13.2 15.2	5.5 551 21.0 5.88 98.0 13.3 15.4			
25		4.5 450 21.6 6.43 107.1 13.7 15.8	4.8 482 21.9 6.66 110.9 13.8 16.0	5.5 551 22.3 7.16 119.2 14.5 16.7	6.2 620 22.6 7.59 126.4 14.9 17.2	6.9 689 22.9 8.04 134.0 15.4 17.8			
33		4.5 450 21.9 6.95 115.8 14.4 16.7	4.8 482 22.3 7.18 119.6 14.5 16.7	5.5 551 22.9 7.70 128.3 14.7 17.0	6.2 620 23.5 8.13 135.5 14.8 17.0	6.9 689 24.1 8.61 143.5 14.8 17.1			
38		4.5 450 23.2 7.93 132.1 14.8 17.1	4.8 482 23.8 8.22 137.0 14.5 16.8	5.5 551 24.4 8.88 148.0 14.9 17.2	6.2 620 25.0 9.36 156.0 15.0 17.3	6.9 689 25.6 9.88 164.7 15.1 17.4			
43		- - - - - - - -	4.8 482 24.7 9.36 156.0 15.4 17.7	5.5 551 25.3 9.88 164.7 15.4 17.8	6.2 620 26.2 10.49 174.9 15.3 17.6	6.9 689 27.1 11.06 184.3 15.0 17.4			
48		- - - - - - - -	4.8 482 25.3 10.52 175.3 16.4 19.0	5.5 551 25.9 10.99 183.2 16.4 18.9	6.2 620 27.1 11.74 195.7 16.0 18.4	6.9 689 27.7 12.38 206.3 16.1 18.6			
53		- - - - - - - -	4.8 482 26.5 11.52 191.9 16.4 18.9	5.5 551 27.1 12.06 201.0 16.4 18.9	6.2 620 28.0 12.81 213.5 16.3 18.8	6.9 689 28.7 13.54 225.6 16.5 19.0			

● = Nozzle plug P/N 315300 installed in the back side of the nozzle housing.

* Complies to ASAE standard. All precipitation rates calculated for 360° operation. All triangular rates are equilateral.

B SERIES



These cost-effective block rotors have a powerful gear drive backed by the reliability synonymous with the Hunter name.

KEY BENEFITS

- G-70-B is a dedicated, true full-circle model
- G-75-B is an adjustable part-circle model (50° to 360°)

OPERATING SPECIFICATIONS

- G-70-B
 - Radius: 16.2 to 22.9 m
 - Discharge rate: 2.95 to 7.66 m³/hr; 49.2 to 127.6 l/min
 - Pressure range: 3.4 to 6.9 bar; 340 to 690 kPa
- G-75-B
 - Radius: 14.3 to 21.6 m
 - Discharge rate: 1.75 to 7.34 m³/hr; 29.1 to 122.3 l/m
 - Pressure range: 2.8 to 6.9 bar; 280 to 690 kPa
- All B Series Golf Rotors are pressure-rated at 10 bar; 1,000 kPa
- Check height up to 2 m in elevation change
- Nozzle range: #8 to #28
 - G-70-B has 6 standard trajectory (25°)
 - G-75-B has 9 standard trajectory (25°)



G-70-B

Pop-up height: 8 cm
Overall height: 23 cm
Flange diameter: 12 cm
Female inlet: 1/4" (30 mm) Acme



G-75-B

Pop-up height: 8 cm
Overall height: 23 cm
Flange diameter: 12 cm
Female inlet: 1/4" (30 mm) Acme

G-70-B & G-75-B - SPECIFICATION BUILDER: ORDER 1 + 2 + 3 + 4

1	Model	2	Valve Options	3	Nozzle	4	Options
G-70	Full-circle	B	Block rotor with check valve	25	Installed G70 nozzle *	S	SSU *
				* Available in SSU model only SSU = #25 (includes nozzle pack)		* Standard stocking unit	
G-75	Full/part-circle, 50°-360° arc range	B	Block rotor with check valve	25	Installed G75 nozzle **	S	SSU *
				** Available in SSU model only SSU = #25 (includes nozzle pack)		* Standard stocking unit	

Example:

G-70-B-25-S = G-70 full-circle block rotor, installed #25 nozzle with nozzle pack, standard stocking unit model

G-70-B NOZZLE PERFORMANCE DATA*							
Nozzle	Pressure		Radius m	Flow		Precip mm/hr	
	bar	kPa		m ³ /hr	l/min	■	▲
15 ● Grey	3.4	340	16.2	2.95	49.2	11.3	13.1
	4.1	410	16.5	3.20	53.4	11.8	13.7
	4.5	450	16.8	3.36	56.0	12.0	13.8
	4.8	480	17.1	3.52	58.7	12.1	14.0
	5.5	550	17.7	3.70	61.7	11.8	13.7
18 ● Red	3.4	340	17.7	3.23	53.8	10.3	11.9
	4.1	410	18.0	3.61	60.2	11.2	12.9
	4.5	450	18.3	3.70	61.7	11.1	12.8
	4.8	480	18.3	3.84	64.0	11.5	13.3
	5.5	550	18.6	4.04	67.4	11.7	13.5
20 ● Dk. Brown	3.4	340	18.6	4.27	71.2	12.4	14.3
	4.1	410	18.9	4.45	74.2	12.5	14.4
	4.5	450	19.2	4.66	77.6	12.6	14.6
	4.8	480	19.5	5.00	83.3	13.1	15.2
	5.5	550	19.5	5.32	88.6	14.0	16.1
23 ● Dk. Green	3.4	340	19.2	4.57	76.1	12.4	14.3
	4.1	410	19.8	4.77	79.5	12.2	14.0
	4.5	450	19.8	4.97	82.9	12.7	14.6
	4.8	480	20.1	5.32	88.6	13.1	15.2
	5.5	550	20.4	5.66	94.3	13.6	15.7
25 ● Dk. Blue	3.4	340	19.8	4.95	82.5	12.6	14.6
	4.1	410	20.4	5.11	85.2	12.3	14.1
	4.5	450	20.4	5.36	89.3	12.9	14.8
	4.8	480	21.0	5.75	95.8	13.0	15.0
	5.5	550	21.6	6.11	101.8	13.0	15.1
28 ● Black	4.8	480	21.6	6.38	106.4	13.6	15.7
	5.5	550	21.6	6.79	113.2	14.5	16.7
	6.2	620	22.3	7.22	120.4	14.6	16.8
	6.9	690	22.9	7.66	127.6	14.6	16.9

* Complies to ASAE standard. All precipitation rates calculated for 360° operation. All triangular rates are equilateral. To calculate precipitation rates for 180° operation, multiply by 2.

G-75-B NOZZLE PERFORMANCE DATA*							
Nozzle	Pressure		Radius m	Flow		Precip mm/hr	
	bar	kPa		m ³ /hr	l/min	■	▲
8 ● Lt. Brown	2.8	280	14.3	1.75	29.1	8.5	9.8
	3.4	340	14.9	1.89	31.4	8.5	9.8
	4.1	410	15.2	2.09	34.8	9.0	10.4
	4.5	450	15.2	2.16	36.0	9.3	10.7
	4.8	480	15.5	2.25	37.5	9.3	10.7
10 ● Lt. Green	3.4	340	16.2	2.48	41.3	9.5	11.0
	4.1	410	16.5	2.73	45.4	10.1	11.6
	4.5	450	16.5	2.84	47.3	10.5	12.1
	4.8	480	16.8	2.98	49.6	10.6	12.2
	5.5	550	17.1	3.25	54.1	11.1	12.9
13 ● Lt. Blue	3.4	340	16.8	2.54	42.4	9.1	10.5
	4.1	410	17.1	2.79	46.6	9.6	11.1
	4.5	450	17.1	2.91	48.5	10.0	11.5
	4.8	480	17.4	3.02	50.3	10.0	11.6
	5.5	550	17.4	3.25	54.1	10.8	12.4
15 ● Grey	3.4	340	17.4	3.04	50.7	10.1	11.6
	4.1	410	17.7	3.25	54.1	10.4	12.0
	4.5	450	18.0	3.36	56.0	10.4	12.0
	4.8	480	18.0	3.48	57.9	10.7	12.4
	5.5	550	18.3	3.73	62.1	11.2	12.9
18 ● Red	3.4	340	18.3	3.29	54.9	9.8	11.4
	4.1	410	18.6	3.57	59.4	10.3	11.9
	4.5	450	18.6	3.70	61.7	10.7	12.4
	4.8	480	18.9	3.84	64.0	10.7	12.4
	5.5	550	19.2	4.13	68.9	11.2	12.9
20 ● Dk. Brown	4.1	410	18.9	4.04	67.4	11.3	13.1
	4.5	450	18.9	4.13	68.9	11.6	13.4
	4.8	480	19.2	4.36	72.7	11.8	13.7
	5.5	550	19.5	4.66	77.6	12.2	14.1
	6.2	620	19.8	4.95	82.5	12.6	14.6
23 ● Dk. Green	4.1	410	19.5	4.97	82.9	13.1	15.1
	4.5	450	19.8	4.86	81.0	12.4	14.3
	4.8	480	19.8	5.36	89.3	13.7	15.8
	5.5	550	20.1	5.82	96.9	14.4	16.6
	6.2	620	20.4	6.13	102.2	14.7	17.0
25 ● Dk. Blue	4.1	410	19.8	5.34	89.0	13.6	15.7
	4.5	450	19.8	5.63	93.9	14.4	16.6
	4.8	480	20.4	5.82	96.9	13.9	16.1
	5.5	550	21.0	6.20	103.3	14.0	16.2
	6.2	620	21.6	6.59	109.8	14.1	16.2
28 ● Black	4.8	480	20.1	6.11	101.8	15.1	17.4
	5.5	550	20.7	6.56	109.4	15.3	17.6
	6.2	620	21.3	6.95	115.8	15.3	17.6
	6.9	690	21.6	7.34	122.3	15.7	18.1

G-70-B & G-75-B NOZZLES



G-70-B



G-75-B

B SERIES



These cost-effective block rotors have shorter-radius, lower-flow nozzles for use in smaller areas.

KEY BENEFITS

- Adjustable, shorter-radius model (50° to 360°)

OPERATING SPECIFICATIONS

- Radius: 5.5 to 15.2 m
- Flow: 0.43 to 2.91 m³/hr; 7.2 to 48.5 l/min
- Pressure range: 2.8 to 4.5 bar; 280 to 450 kPa
- All B Series Golf Rotors are pressure-rated at 10 bar; 1,000 kPa
- Check height up to 2 m in elevation change
- Nozzle range: #2 to #12



G-35-B

Pop-up height: 8 cm
Overall height: 23 cm
Flange diameter: 12 cm
Female inlet: 1/4" (30 mm) Acme

G-35-B - SPECIFICATION BUILDER: ORDER 1 + 2 + 3 + 4

1 Model	2 Valve Options	3 Nozzle	4 Options*
G-35 = Full/part-circle 50° to 360°	B = Block rotor with check valve	6 = Installed G35 nozzle* * Available in SSU model only SSU = #6 (includes nozzle rack)	S = SSU* * Standard stocking unit

Example:

G-35-B-6-S = G-35 full/part-circle block rotor, installed #6 nozzle with nozzle rack, standard stocking unit model

G-35-B NOZZLE PERFORMANCE DATA*

Nozzle	Pressure		Radius m	Flow		Precip mm/hr	
	bar	kPa		m ³ /hr	l/min	■	▲
2 ● Yellow	2.8	280	5.5	0.43	7.2	14.3	16.6
	3.4	340	6.1	0.48	7.9	12.8	14.8
	4.1	410	6.7	0.55	9.1	12.1	14.0
	4.5	450	7.0	0.59	9.8	12.0	13.9
3 ● Yellow	2.8	280	7.0	0.68	11.4	13.9	16.0
	3.4	340	7.6	0.73	21.1	12.5	14.5
	4.1	410	8.2	0.80	13.2	11.7	13.6
	4.5	450	8.5	0.82	13.6	11.2	13.0
4 ● Yellow	2.8	280	7.6	0.89	14.8	15.3	17.6
	3.4	340	8.5	0.93	15.5	12.8	14.8
	4.1	410	9.1	1.00	16.7	12.0	13.8
	4.5	450	9.4	1.04	17.4	11.7	13.5
5 ● Yellow	2.8	280	8.8	1.07	17.8	13.7	15.8
	3.4	340	9.8	1.14	18.9	11.9	13.8
	4.1	410	10.1	1.20	20.1	11.9	13.7
	4.5	450	10.7	1.23	20.4	10.8	12.4
6 ● Yellow	2.8	280	9.8	1.36	22.7	14.3	16.5
	3.4	340	10.7	1.43	23.8	12.6	14.5
	4.1	410	11.3	1.50	25.0	11.8	13.6
	4.5	450	11.9	1.54	25.7	10.9	12.6
8 ● Yellow	2.8	280	11.0	1.77	29.5	14.7	17.0
	3.4	340	11.9	1.82	30.3	12.9	14.8
	4.1	410	12.8	1.89	31.4	11.5	13.3
	4.5	450	13.1	1.93	32.2	11.2	13.0
10 ● Yellow	2.8	280	11.9	2.20	36.7	15.6	18.0
	3.4	340	13.1	2.29	38.2	13.4	15.4
	4.1	410	13.7	2.34	39.0	12.4	14.4
	4.5	450	14.3	2.39	39.7	11.6	13.4
12 ● Yellow	2.8	280	13.4	2.73	45.4	15.2	17.5
	3.4	340	14.3	2.77	46.2	13.5	15.6
	4.1	410	14.6	2.84	47.3	13.3	15.3
	4.5	450	15.2	2.91	48.5	12.5	14.5

G-35-B NOZZLES



* Complies to ASAE standard. All precipitation rates calculated for 360° operation. All triangular rates are equilateral. To calculate precipitation rates for 180° operation, multiply by 2.

G-35-B ROTOR



G-900 SERIES



These rotors are simple to install and perfect for retrofits. Total-Top-Serviceability makes field maintenance quick and easy.

KEY BENEFITS

- G-990 is a dedicated, true full-circle model
- G-995 is an adjustable part-circle model (40° to 360°)
- Higher flow, longer radius rotor designed for single row systems
- Contour back nozzle capability for special applications

OPERATING SPECIFICATIONS

- G-990
 - Radius: 27.1 to 31.4 m
 - Flow: 12.31 to 18.92 m³/hr; 205.2 to 315.3 l/min
 - Pressure range: 5.5 to 8.3 bar; 550 to 830 kPa
- G-995
 - Radius: 24.7 to 29.6 m
 - Flow: 12.47 to 19.04 m³/hr; 207.8 to 317.2 l/min
 - Pressure range: 5.5 to 8.3 bar; 550 to 830 kPa
- All TTS rotors are pressure-rated at 10 bar; 1,000 kPa
- Check height up to 2 m in elevation change
- Nozzle range: #53 to #73
 - 3 standard trajectory (22.5°)
 - 3 low-angle trajectory (15°)

OPTIONS

- C - Check-o-Matic Technology checks up to 8 m in elevation change and readily converts to normally open hydraulic with through-the-top connections
- D - Decoder Valve-in-Head Technology with all “E” specifications below*
- DD - Two-station decoder Valve-in-Head Technology with all “E” specifications below*
- E - Electric Valve-in-Head Technology with adjustable pressure regulation, on-off-auto selector, 210 mA (370 mA inrush) 50 Hz; 190 mA (350 mA inrush) 60 Hz solenoid with captive plunger and internal downstream bleed

* All DIH rotors include two 3M DBRY-6 splices for connection to the two-wire path. See **page 200** for critical recommendations on grounding DIH rotors.



G-990C

Pop-up height: 8 cm
Overall height: 34 cm
Flange diameter: 19 cm
Female inlet: 1½" (40 mm) Acme



G-995E

Pop-up height: 8 cm
Overall height: 34 cm
Flange diameter: 19 cm
Female inlet: 1½" (40 mm) Acme

G-990 & G-995 - SPECIFICATION BUILDER: ORDER 1 + 2 + 3 + 4 + 5

1 Model	2 Valve Options	3 Nozzle	4 Regulation*	5 Options
G-990 = Full-circle	C = Check-o-Matic Technology* D = Decoder Valve-in-Head Technology DD = Two-station decoder Valve-in-Head Technology E = Electric Valve-in-Head Technology	53 to 73 = Installed G-990 nozzle*	P8 = 80 PSI; 5.5 bar; 550 kPa (nozzle 53) P1 = 100 PSI; 6.9 bar; 690 kPa (nozzles 53 to 73) P2 = 120 PSI; 8.3 bar; 830 kPa (nozzle 73)	S = SSU*
G-995 = Adjustable arc, 40°-360°	C = Check-o-Matic Technology* D = Decoder Valve-in-Head Technology DD = Two-station decoder Valve-in-Head Technology E = Electric Valve-in-Head Technology *Converts to N.O. hydraulic Valve-in-Head Technology	53 to 73 = Installed G-995 nozzle* * SSU = #53	P8 = 80 PSI; 5.5 bar; 550 kPa (nozzle 53) P1 = 100 PSI; 6.9 bar; 690 kPa (nozzles 53 to 73) P2 = 120 PSI; 8.3 bar; 830 kPa (nozzle 73) * SSU = P8/#53	S = SSU* *Standard stocking unit

Example:

G-990-E-53-P8-S = G-990 full-circle electric Valve-in-Head Technology, installed #53 nozzle, 80 PSI; 5.5 bar; 550 kPa regulation, standard stocking unit model

G-990 NOZZLE PERFORMANCE DATA*							
Nozzle	Pressure		Radius**	Flow		Precip mm/hr	
	bar	kPa		m ³ /hr	l/min	■	▲
53 ● Dk. Blue	5.5	550	27.1	12.31	205.2	16.7	19.3
	6.2	620	27.4	12.88	214.6	17.1	19.8
	6.9	690	28.0	13.45	224.1	17.1	19.7
	7.6	760	28.3	14.02	233.6	17.4	20.1
	8.3	830	28.7	14.58	243.0	17.8	20.5
63 ● Black	5.5	550	28.0	14.36	23.92	18.3	21.1
	6.2	620	28.7	14.97	249.5	18.2	21.1
	6.9	690	29.3	15.76	265.7	18.4	21.3
	7.6	760	29.6	16.36	272.5	18.7	21.6
	8.3	830	29.9	17.01	283.5	19.1	22.0
73 ● Orange	5.5	550	29.3	16.38	272.9	19.1	22.1
	6.2	620	29.9	17.04	283.9	19.1	22.0
	6.9	690	30.2	17.67	297.5	19.4	22.4
	7.6	760	31.1	18.29	304.7	18.9	21.8
	8.3	830	31.4	18.92	315.3	19.2	22.2

G-995 NOZZLE PERFORMANCE DATA*							
Nozzle	Pressure		Radius**	Flow		Precip mm/hr	
	bar	kPa		m ³ /hr	l/min	■	▲
53 ● Dk. Blue	5.5	550	24.7	12.47	207.8	20.5	23.6
	6.2	620	25.6	12.99	216.5	19.8	22.9
	6.9	690	26.2	13.52	225.2	19.7	22.7
	7.6	760	26.5	14.11	235.1	20.1	23.2
	8.3	830	26.8	14.63	243.8	20.3	23.5
63 ● Black	5.5	550	26.2	14.15	235.8	20.6	23.8
	6.2	620	26.8	14.88	247.9	20.7	23.9
	6.9	690	27.4	15.67	261.2	20.8	24.0
	7.6	760	27.7	16.33	272.2	21.2	24.5
	8.3	830	28.0	16.97	282.8	21.6	24.9
73 ● Orange	5.5	550	27.1	16.51	275.2	22.4	25.9
	6.2	620	27.7	17.13	285.4	22.3	25.7
	6.9	690	28.3	17.74	295.6	22.1	25.5
	7.6	760	29.0	18.38	306.2	21.9	25.3
	8.3	830	29.6	19.04	317.2	21.8	25.1

G-900 NOZZLES



G-900 LOW-ANGLE NOZZLES**



** Low-angle nozzles reduce the radius by 15%.

* Complies to ASAE standard. All precipitation rates calculated for 360° operation. All triangular rates are equilateral. To calculate precipitation rates for 180° operation, multiply by 2.



Contour Back-Nozzle Capabilities

Choose any nozzle from the I-40, and G-70 nozzle racks, or from the short- and mid-range G-900 nozzles.

GOLF SWING JOINTS

With swivel ells on both ends, SJ Swing Joints easily adjust sprinklers to proper height and position in any configuration.

KEY BENEFITS













- Strength, longevity and contamination resistance
 - Prefabricated PVC design with O-ring seals
- Configurations to meet every installation requirement
 - Available in all popular inlet and outlet configurations
 - Choose from 20 cm, 30 cm, or 46 cm lay arm lengths
 - Single top-out or triple top-out designs

Swing Joints

- HSJ-0 = Model ¾"
- HSJ-1 = Model 1" (25 mm)
- HSJ-2 = Model 1¼" (30 mm)
- HSJ-3 = Model 1½" (40 mm)



SWING JOINT - SPECIFICATION BUILDER: ORDER 1 + 2 + 3 + 4 + 5

1 Model	2 Inlet Type (from pipe fitting)	3 Outlet Type (to sprinkler inlet)	4 Outlet Style	5 Lay Length
HSJ-0 = ¾" commercial swing joint HSJ-1 = 1" (25 mm) heavy-duty swing joint HSJ-2 = 1¼" (30 mm) heavy-duty swing joint HSJ-3 = 1½" (40 mm) heavy-duty swing joint	3 = Male NPT  4 = Male Acme*  6 = Male BSP**  7 = Spigot, 10 cm long**  B = Additional elbow for Male BSP inlet, allows vertical mounting. Available for outlet types 0, 5, 8. M = Main Acme H-connection P = Main Acme V-connection	0 = Male Acme  2 = Male NPT  5 = Male BSP (not available in HSJ-0)  6 = Enlarging to 1½" (40 mm) male BSP* 8 = Enlarging to 1½" (40 mm) male Acme* A = Enlarging/reducing to 1¼" (30 mm) male Acme**	2 = Single top-out  4 = Triple top-out 	8 = 20 cm lay arm†  12 = 30 cm lay arm  18 = 46 cm lay arm† 

Example:

HSJ-3-M-0-2-12 = HSJ 1½" (40 mm) heavy-duty swing joint, 1½" (40 mm) male Acme horizontal connection to mainline tee, 1½" (40 mm) male Acme single top outlet, 30 cm lay arm length.

* Not available in HSJ-0 or HSJ-3. Use "M" inlet for HSJ-3. ** Not available in HSJ-0. *** Horizontal connection reduces from 1½" (40 mm) Acme to swing joint size. † HSJ-0 only.
 ‡ Not available in HSJ-0

ACME ADAPTER FITTINGS

Choose Hunter Acme Adapter Fittings for maximum system design flexibility.



1¼" (30 mm) Models

- 1¼" (30 mm) male Acme x 1" (25 mm) female NPT P/N 109325
- 1¼" (30 mm) male Acme x 1" (25 mm) female BSP P/N 105329
- 1¼" (30 mm) male Acme x 1¼" (30 mm) female NPT P/N 474800
- 1¼" (30 mm) male Acme x 1¼" (30 mm) female BSP P/N 474900
- 1¼" (30 mm) male Acme x 1½" (40 mm) female NPT P/N 104153
- 1¼" (30 mm) male Acme x 1½" (40 mm) female BSP P/N 107262



1½" (40 mm) Models

- 1½" (40 mm) male Acme x 1" (25 mm) female NPT P/N 475400
- 1½" (40 mm) male Acme x 1" (25 mm) female BSP P/N 475500
- 1½" (40 mm) male Acme x 1¼" (30 mm) female NPT P/N 475200
- 1½" (40 mm) male Acme x 1¼" (30 mm) female BSP P/N 475300
- 1½" (40 mm) male Acme x 1½" (40 mm) female NPT P/N 475000
- 1½" (40 mm) male Acme x 1½" (40 mm) female BSP P/N 475100



Acme x Acme Models

- 1½" (40 mm) male Acme x 1" (25 mm) Acme female P/N 225300
- 1½" (40 mm) male Acme x 1¼" (30 mm) Acme female P/N 225400
- 1¼" (30 mm) male Acme x 1" (25 mm) Acme female P/N 225500



B2B Tee Assembly

- 1½" (40 mm) Acme threaded tee and 40 mm adapter for connecting two swing joints to a single mainline connection in back-to-back installations around greens.
- P/N = HSJ-305-015-3 = NPT inlet
 - P/N = HSJ-305-015-6 = BSP inlet
 - P/N = HSJ-305-015-M = Acme inlet (shown)

ROTOR ACCESSORIES

Customise golf rotors according to course needs with these useful accessories.

HOSE SWIVEL ADAPTERS

Models

- Hose Swivel Adapter for G-900 Series (fits ¾" and 1" hose) P/N G90HS100
- Hose Swivel Adapter for G-800 Series (fits ¾" and 1" hose) P/N G800HS100



Hose Swivel Adapters

RUBBER COVER KITS

Models

- TTS-800 Series Low-Bounce Rubber Cover Kit P/N 987200SP
- TTS-800 Series Low-Bounce Rubber Cover Kit (Green) P/N 987201SP
- TTS-800 Series No-Bounce Turf Cup Kit P/N 987100SP
- G-990 Series Rubber Cover Kit (date codes 06/11 and prior only) P/N 473800
- G-995 Series Rubber Cover Kit (also G990 date codes 07/11 and after) P/N 473900



Rubber Cover Kit

GOLF TOOLS

Use these helpful tools to simplify installation and maintenance.



**Arc Adjustment/
Riser Holdup Tool**

P/N 382800SP
G-85B/GT-885



**Valve Insertion/
Removal Tool**

P/N 604000SP
TTS-800 and G-800 Series



**Valve Insertion/
Removal Tool**

P/N 280500SP
G-900 Series



**Valve & Snap Ring
Insertion/Removal Pliers**

P/N 475600SP
TTS-800 and G-800 Series



Snap Ring Removal Tool

P/N 251000SP
All Golf Models



TECHNICAL INFORMATION



PRECIPITATION RATES



In this section, the “Sprinkler Spacing Method–Any Arc and Any Spacing” equation is used to calculate precipitation rates. The first set of equations with the ■ shows the precipitation rate for the sprinklers when they are laid out in a square pattern. The next set with the ▲ shows the precipitation rate for the sprinklers laid out in an equilateral triangular spacing pattern. This is the “Sprinkler Spacing Method–Equilateral Triangular Spacing” equation.

WHAT IS PRECIPITATION RATE?

If someone said they were caught in a rainstorm that dropped 25 mm of water in an hour, you would have some idea of how hard or heavily the rain came down. A rainstorm that covers an area with 25 mm of water in one hour has a precipitation rate of 25 mm per hour. Similarly, the precipitation rate is the speed at which a sprinkler or an irrigation system applies water.

MATCHED PRECIPITATION RATES

A zone or system in which all the heads have similar precipitation rates is said to have “matched precipitation rates.” Systems that have matched precipitation rates reduce wet and dry spots and minimise run times, which reduces water consumption and lowers costs. Knowing that sprinkler spacing, flow rates, and arcs of coverage affect precipitation rates, a general guideline is: as the spray arc doubles, so should the flow.

	90° Arc = 1 GPM; 0.23 m ³ /hr; 3.8 l/min		180° Arc = 2 GPM; 0.45 m ³ /hr; 7.6 l/min		360° Arc = 4 GPM; 0.91 m ³ /hr; 15.1 l/min
--	--	---	---	---	--

The flow rate of half-circle heads must be two times the flow rate of the quarter-circle heads, and the full-circle heads must have two times the flow rate of the half-circle heads. In the illustration, the same amount of water is applied to each quarter circle area and precipitation is therefore matched.

CALCULATING PRECIPITATION RATES

Depending upon the construction of the irrigation system, the precipitation rate may be calculated by either a Sprinkler Spacing or a Total Area method.

Sprinkler Spacing Method (■)

The precipitation rate should be calculated for each individual zone. If all sprinkler heads on the zone have the same spacing, flow rate, and arc of coverage, use one of the following formulas:

Any Arc and Any Spacing (■):

$$\text{P.R. (in/hr)} = \frac{\text{Flow Rate (GPM) for any Arc} \times 34,650}{\text{Degrees of Arc} \times \text{Head Spacing (ft.)} \times \text{Row Spacing (ft.)}}$$

$$\text{P.R. (mm/hr)} = \frac{\text{Flow Rate (m}^3\text{/hr) for any Arc} \times 360,000}{\text{Degrees of Arc} \times \text{Head Spacing (m)} \times \text{Row Spacing (m)}}$$

$$\text{P.R. (mm/hr)} = \frac{\text{Flow Rate (l/min) for any Arc} \times 21,600}{\text{Degrees of Arc} \times \text{Head Spacing (m)} \times \text{Row Spacing (m)}}$$

Sprinkler Spacing Method (▲)

The precipitation rate should be calculated for each individual zone. If all sprinkler heads on the zone have the same spacing, flow rate, and arc of coverage, use one of the following formulas:

Equilateral Triangular Spacing (▲):

$$\text{P.R. (in/hr)} = \frac{\text{Flow Rate (GPM) for any Arc} \times 34,650}{\text{Degrees of Arc} \times (\text{Head Spacing})^2 \times 0.866}$$

$$\text{P.R. (mm/hr)} = \frac{\text{Flow Rate (m}^3\text{/hr) for any Arc} \times 360,000}{\text{Degrees of Arc} \times (\text{Head Spacing})^2 \times 0.866}$$

$$\text{P.R. (mm/hr)} = \frac{\text{Flow Rate (l/min) for any Arc} \times 21,600}{\text{Degrees of Arc} \times (\text{Head Spacing})^2 \times 0.866}$$

Total Area Method

The precipitation rate for a “system” is the average precipitation rate of all sprinklers in an area, regardless of the spacing, flow rate, or arc for each head. The Total Area Method calculates all the flows of all of the heads in any given area.

$$\text{P.R. (in/hr)} = \frac{\text{Flow (GPM)} \times 96.25}{\text{Total Area (ft.)}}$$

$$\text{P.R. (mm/hr)} = \frac{\text{Flow (m}^3\text{/hr)} \times 1,000}{\text{Total Area (m}^2\text{)}}$$

$$\text{P.R. (mm/hr)} = \frac{\text{Flow (l/min)} \times 60}{\text{Total Area (m}^2\text{)}}$$

SLOPE EQUIVALENTS/IRRIGATION

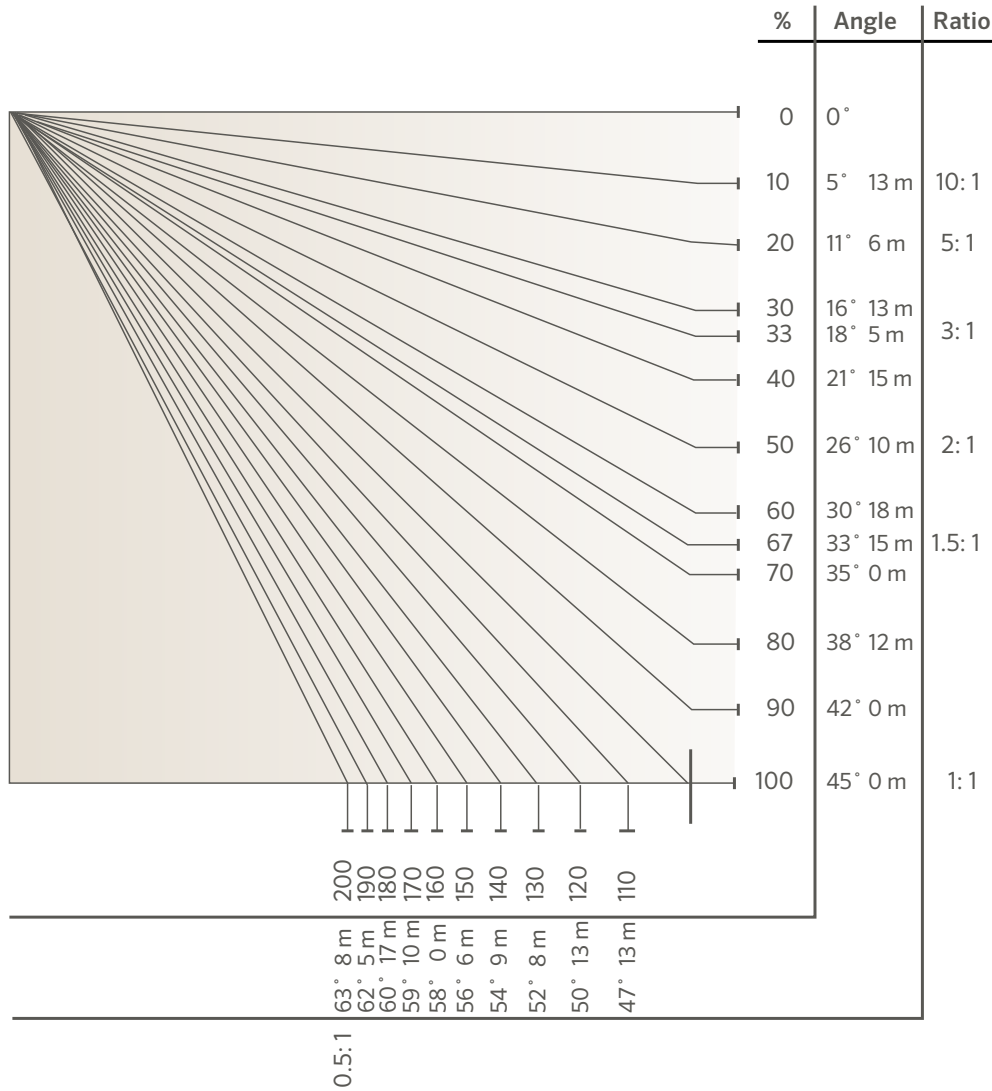

SLOPE IRRIGATION: Maximum precipitation rates for slopes in mm/hr

Soil Texture	0 to 5% Slope		5 to 8% Slope		8 to 12% Slope		12%+ Slope	
	Cover	Bare	Cover	Bare	Cover	Bare	Cover	Bare
Coarse sandy soils	51	51	51	38	38	25	25	13
Coarse sandy soils over compact subsoils	44	38	32	25	25	19	19	10
Light sandy loams uniform	44	25	32	20	25	15	19	10
Light sandy loams over compact subsoils	32	19	25	13	19	10	13	8
Uniform silt loams	25	13	20	10	15	8	10	5
Silt loams over compact subsoil	15	8	13	6	10	4	8	3
Heavy clay or clay loam	5	4	4	3	3	2	3	2

Notes:

The maximum precipitation values listed below are those suggested by the United States Department of Agriculture. The values are average and may vary with respect to actual soil and groundcover conditions.

HEIGHT OF SPRAY

The trajectory and spray height of the water stream leaving a sprinkler nozzle is important information when designing and installing irrigation systems.

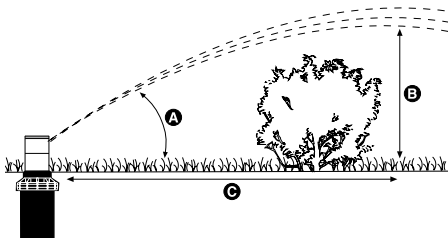

These rotor nozzle trajectory charts are designed to help determine how close a sprinkler can be placed to an object such as a fence or hedge without obstructing the spray pattern. All information shown is at optimum operating pressures.

HUNTER NOZZLE HEIGHT AND TRAJECTORY CHART						
Model	Nozzle No.	Pressure		Degrees of Trajectory	Max Height of Spray (m)	Distance from Head to Maximum Height (m)
		bar	kPa			
MP ROTATOR®	800SR	2.8	280	18	0.5	Varies
	815	2.8	280	15	0.3	Varies
	1000	2.8	280	20	0.5	Varies
	2000	2.8	280	26	1.1	Varies
	3000	2.8	280	26	2.0	Varies
	3500	2.8	280	28	2.5	Varies
	Corner	2.8	280	14	0.4	Varies
	Side Strip Left Strip	2.8 2.8	280 280	16 16	0.5 0.5	Varies Varies
PGJ/SRM	0.50	2.8	280	10	0.6	1.2
	0.75	2.8	280	10	0.6	1.2
	1.0	2.8	280	10	0.6	2.4
	1.5	2.8	280	10	0.9	3.7
	2.0	2.8	280	15	1.5	4.9
	2.5	2.8	280	12	1.5	6.1
	3.0	2.8	280	15	1.5	6.1
	4.0	2.8	280	15	1.5	6.7
PGP® RED NOZZLES	1.0	3.5	350	26	2.1	6.7
	2.0	3.5	350	26	2.1	6.7
	3.0	3.5	350	26	2.4	7.0
	4.0	3.5	350	26	2.4	7.0
	5.0	3.5	350	27	2.7	7.9
	6.0	3.5	350	27	3.0	8.5
	7.0	3.5	350	26	3.4	9.1
	8.0	3.5	350	26	3.4	9.1
	9.0	3.5	350	27	3.7	9.8
	10.0	4.0	400	25	4.0	9.8
	11.0	4.0	400	25	4.0	11.6
	12.0	4.0	400	25	4.0	12.2
PGP LOW-ANGLE GREY NOZZLES	4.0	3.5	350	15	1.5	6.7
	5.0	3.5	350	15	1.2	6.7
	6.0	3.5	350	14	1.2	6.7
	7.0	3.5	350	14	1.2	6.7
	8.0	3.5	350	14	1.5	7.3
	9.0	3.5	350	15	1.5	7.9
PGP BLUE NOZZLES	1.5	3.0	300	25	2.4	7.0
	2.0	3.0	300	25	2.4	7.0
	2.5	3.0	300	25	2.7	7.9
	3.0	3.0	300	25	3.0	8.5
	4.0	3.0	300	25	3.4	9.1
	5.0	3.0	300	25	3.4	9.1
	6.0	3.8	380	25	3.7	9.8
	8.0	3.8	380	25	4.0	9.8
PGP ULTRA/1-20 DARK BLUE NOZZLES	1.0	3.5	350	26	2.4	7.0
	1.5	3.5	350	26	2.4	7.0
	2.0	3.5	350	27	2.7	7.9
	3.0	3.5	350	27	3.0	8.5
	3.5	3.5	350	26	3.4	9.1
	4.0	3.5	350	26	3.4	9.1
	6.0	3.5	350	27	3.7	9.8
	8.0	4.0	400	25	4.0	9.8
PGP ULTRA/1-20 BLUE NOZZLES	1.5	3.0	300	25	2.4	7.0
	2.0	3.0	300	25	2.4	7.0
	2.5	3.0	300	25	2.7	7.9
	3.0	3.0	300	25	3.0	8.5
	4.0	3.0	300	25	3.4	9.1
	5.0	3.0	300	25	3.4	9.1
	6.0	3.8	380	25	3.7	9.8
	8.0	3.8	380	25	4.0	9.8

HEIGHT OF SPRAY

HUNTER NOZZLE HEIGHT AND TRAJECTORY CHART						
Model	Nozzle No.	Pressure		Degrees of Trajectory	Max Height of Spray (m)	Distance from Head to Maximum Height (m)
		bar	kPa			
PGP™ Ultra/I-20 Low-Angle Grey Nozzles	2.0 LA	3.5	350	13	1.5	6.7
	2.5 LA	3.5	350	13	1.2	6.7
	3.5 LA	3.5	350	13	1.2	6.7
	4.5 LA	3.5	350	13	1.2	6.7
PGP Ultra/I-20 Short Radius Black Nozzles	0.5	3.5	350	15	1.5	2.4
	1.0	3.5	350	14	1.8	2.7
	2.0	3.5	350	3	0.3	1.8
PGP Ultra/I-20 Short Radius Black Nozzles	0.75	3.5	350	22	2.1	4.0
	1.5	3.5	350	18	2.1	4.0
	3.0	3.5	350	8	0.3	1.8
PGP Ultra/I-20 MPR-25 Red Nozzles	Q - 90	3.0	300	22	0.9	4.6
	T - 120	3.0	300	21	1.2	4.2
	H - 180	3.0	300	24	1.2	4.2
	F - 360	3.0	300	22	1.2	3.0
PGP Ultra/I-20 MPR-30 Lt. Green Nozzles	Q - 90	3.0	300	28	1.5	5.4
	T - 120	3.0	300	14	0.9	5.1
	H - 180	3.0	300	16	1.2	4.8
	F - 360	3.0	300	18	0.6	3.9
PGP Ultra/I-20 MPR-35 Tan Nozzles	Q - 90	3.0	300	28	1.8	5.7
	T - 120	3.0	300	28	1.8	5.4
	H - 180	3.0	300	16	1.2	5.1
	F - 360	3.0	300	14	0.9	3.6
I-25	4	3.5	350	25	2.7	6.7
	7	3.5	350	25	3.0	8.5
	8	3.5	350	25	3.4	8.5
	10	4	400	25	3.7	9.1
	13	4	400	25	4.0	9.4
	15	4	400	25	3.7	9.4
	18	4	400	25	4.6	10.4
	20	5	500	25	4.6	10.7
	23	5	500	25	4.9	11.6
	25	5	500	25	4.9	11.6
	28	5	500	25	5.2	12.2
I-40/I-50 Adjustable	8	3.5	350	25	3.7	9.8
	10	4.0	400	25	4.3	9.8
	13	4.0	400	25	4.3	10.4
	15	4.0	400	25	4.6	12.8
	23	5.0	500	25	5.2	14.0
I-40/I-50-ON	25	5.0	500	25	5.2	14.6
	28	5.0	500	25	5.2	15.2
	15	4.0	400	25	4.6	12.8
	18	4.0	400	25	4.8	13.1
	20	5.0	500	25	5.2	13.7
	23	5.0	500	25	5.2	14.0
	25	5.0	500	25	5.2	14.6
	28	5.0	500	25	5.2	15.2

HEIGHT OF SPRAY

HUNTER NOZZLE HEIGHT AND TRAJECTORY CHART

Model	Nozzle No.	Pressure		Degrees of Trajectory	Max Height of Spray (m)	Distance from Head to Maximum Height (m)
		bar	kPa			
I-80 & I-90 ADV	23	5.5	550	22.5	4.3	11.3
	25	5.5	550	22.5	4.6	12.2
	33	5.5	550	22.5	4.6	12.8
	38	5.5	550	22.5	4.9	14.6
	43	5.5	550	22.5	4.9	14.6
	48	5.5	550	22.5	5.2	16.5
	53	5.5	550	22.5	5.2	17.1
	63	5.5	550	22.5	5.5	19.5
	73	5.5	550	22.5	5.8	20.7
I-80-ON & I-90 36V	23	5.5	550	22.5	4.3	12.5
	25	5.5	550	22.5	4.6	14.0
	33	5.5	550	22.5	4.6	14.0
	38	5.5	550	22.5	4.9	15.3
	43	5.5	550	22.5	4.9	16.5
	48	5.5	550	22.5	5.2	17.1
	53	5.5	550	22.5	5.2	17.7
	63	5.5	550	22.5	5.5	18.9
	73	5.5	550	22.5	5.8	20.7

PILOT-FC FIELD CONTROLLER ELECTRICAL SPECIFICATIONS

ELECTRICAL SPECIFICATIONS

Supply Voltage

Auto-sensing frequency (50 or 60 Hz)

120 VAC nominal (100 to 132 VAC)¹

230 VAC nominal (200 to 260 VAC)¹

Station output: 24 VAC at 1.0 A

CAPACITIES

Station Capacity

80 stations

Up to 20 stations can run simultaneously

Station Solenoid Load

Up to four 24 VAC Hunter golf solenoids per station output³

1. To prevent damage, all Pilot-FC controllers are shipped with the supply voltage set to 230 VAC.
2. One 24 VAC Hunter golf solenoid per station.
3. Multiple solenoids connected to a single station will reduce total simultaneous stations.

PILOT-DH TWO-WAY HUB ELECTRICAL SPECIFICATIONS

ELECTRICAL SPECIFICATIONS

Supply Voltage

Auto-sensing frequency (50 or 60 Hz)

Auto-switching 120/230 VAC nominal (100 to 277 VAC at 50/60 Hz)¹

CAPACITIES

Integrated Two-Way Module Capacity

Up to 999 integrated two-way modules per Pilot-DH two-way hub

Up to 120 24 VAC Hunter golf solenoids on at one time²

Integrated Two-Way Module Solenoid Load

Up to two 24 VAC Hunter golf solenoids per integrated two-way module³

1. The Pilot-DH hub automatically detects supply voltage and frequency.
2. Depends on configuration. Pilot-DH will run up to 30 stations simultaneously per output module.
3. Two solenoids per two-way module does not reduce the maximum simultaneous station count.

PILOT-FC CURRENT REQUIREMENT CHARTS

PILOT-FC FIELD CONTROLLER CURRENT REQUIREMENTS: 230 VAC/50 Hz Supply Voltage, 10 to 40 Stations Various Loads and Communication Options

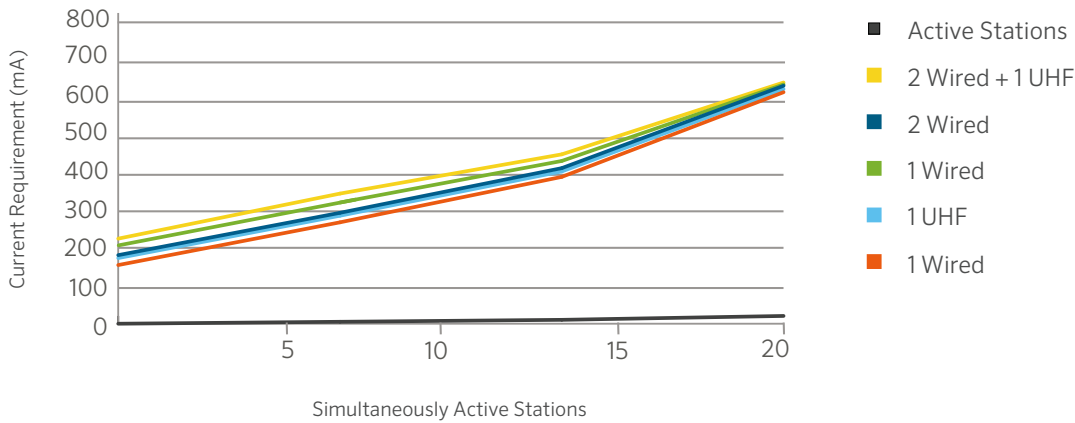

PILOT-FC FIELD CONTROLLER CURRENT REQUIREMENTS: 230 VAC/50 Hz Supply Voltage, 50 to 80 Stations Various Loads and Communication Options

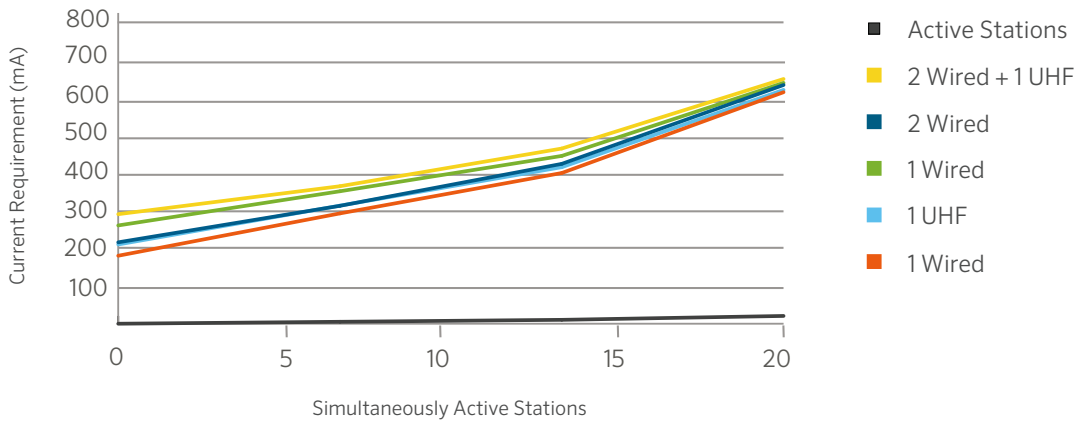

CONVERSION FACTORS

CONVERSION FACTORS			
To Convert	From	To	Multiply By
Area	acres	foot ²	43560
	acres	metre ²	4046.8
	metre ²	foot ²	10.764
	foot ²	inch ²	144
	inch ²	centimetre ²	6.452
	hectares	metre ²	10000
	hectares	acres	2.471
Power	kilowatts	horsepower	1.341
Flow	foot ³ /minute	metre ³ /second	0.0004719
	foot ³ /second	metre ³ /second	0.02832
	yards ³ /minute	metre ³ /second	0.01274
	gallon/minute	metre ³ /hour	0.22716
	gallon/minute	litre/minute	3.7854
	gallon/minute	litre/second	0.06309
	metre ³ /hour	litre/minute	16.645
	metre ³ /hour	litre/second	0.2774
	litre/minute	litre/second	60
Length	foot	inch	12
	inch	centimetre	2.54
	foot	metre	0.30481
	kilometre	miles	0.6214
	miles	foot	5280
	miles	metre	1609.34
	millimetre	inch	0.03937
Pressure	PSI	kilopascals	6.89476
	PSI	bar	0.068948
	bar	kilopascals	100
	PSI	feet of head	2.31
Velocity	feet/second	metre/second	0.3048
Volume	feet ³	gallon	7.481
	feet ³	litre	28.32
	metre ³	feet ³	35.31
	metre ³	yard ³	1.3087
	yard ³	feet ³	27
	yard ³	gallon	202
	acres/feet	foot ³	43,560
	gallon	metre ³	0.003785
	gallon	litre	3.785
	imperial gallon	gallon	1.833

FRICION LOSS CHARTS - UPVC PIPE CLASS 3 (6 BAR)

C = 150 • PRESSURE LOSS (BAR/100 METRES)

Nominal Size		40 mm		50 mm		63 mm		75 mm		90 mm		110 mm		160 mm		200 mm	
Pipe ID		36.4 mm		46.4 mm		59.2 mm		70.6 mm		84.6 mm		103.6 mm		153.2 mm		188.2 mm	
Pipe OD		40 mm		50 mm		63 mm		75 mm		90 mm		110 mm		160 mm		200 mm	
Wall Thick		1.8 mm		1.8 mm		1.9 mm		2.2 mm		2.7 mm		3.2 mm		3.4 mm		5.9 mm	
Flow l/min	Flow m ³ /hr	Velocity m/s	bar loss	Velocity m/s	bar loss	Velocity m/s	bar loss	Velocity m/s	bar loss	Velocity m/s	bar loss	Velocity m/s	bar loss	Velocity m/s	bar loss	Velocity m/s	bar loss
3.8	0.25																
7.6	0.5																
11.4	0.75																
15.1	1	0.3	0.03														
26.5	1.5	0.4	0.06	0.2	0.02												
34.1	2	0.5	0.09	0.3	0.03												
41.6	2.5	0.7	0.14	0.4	0.04												
49.2	3	0.8	0.20	0.5	0.06												
56.8	3.5	0.9	0.27	0.6	0.08												
68.1	4	1.1	0.34	0.7	0.10												
83.3	5	1.3	0.52	0.8	0.16												
98.4	6	1.6	0.72	1.0	0.22	0.6	0.07	0.4	0.03								
117.3	7	1.9	0.96	1.1	0.30	0.7	0.09	0.5	0.04								
132.5	8	2.1	1.23	1.3	0.38	0.8	0.12	0.6	0.05								
151.4	9	2.4	1.53	1.5	0.47	0.9	0.14	0.6	0.06								
166.6	10	2.7	1.86	1.6	0.57	1.0	0.17	0.7	0.07								
181.7	11			1.8	0.68	1.1	0.21	0.8	0.09	0.5	0.04						
200.6	12			2.0	0.8	1.2	0.24	0.9	0.10	0.6	0.04						
215.8	13			2.1	0.93	1.3	0.28	0.9	0.12	0.6	0.05						
234.7	14			2.3	1.07	1.4	0.33	1.0	0.14	0.7	0.06						
249.8	15			2.5	1.21	1.5	0.37	1.1	0.16	0.7	0.06	0.5	0.02				
265.0	16					1.6	0.42	1.1	0.18	0.8	0.07	0.5	0.03				
283.9	17					1.7	0.47	1.2	0.20	0.8	0.08	0.6	0.03				
299.0	18					1.8	0.52	1.3	0.22	0.9	0.09	0.6	0.03				
318.0	19					1.9	0.57	1.3	0.24	0.9	0.10	0.6	0.04				
333.1	20					2.0	0.63	1.4	0.27	1.0	0.11	0.7	0.04				
348.3	21					2.1	0.69	1.5	0.29	1.0	0.12	0.7	0.05				
367.2	22					2.2	0.75	1.6	0.32	1.1	0.13	0.7	0.05				
382.3	23					2.3	0.82	1.6	0.35	1.1	0.14	0.8	0.05				
401.3	24							1.7	0.37	1.2	0.16	0.8	0.06				
416.4	25							1.8	0.40	1.2	0.17	0.8	0.06				
431.5	26							1.8	0.43	1.3	0.18	0.9	0.07				
450.5	27							1.9	0.47	1.3	0.19	0.9	0.07				
465.6	28							2.0	0.50	1.4	0.21	0.9	0.08				
484.5	29							2.1	0.53	1.4	0.22	1.0	0.08				
499.7	30							2.1	0.57	1.5	0.23	1.0	0.09				
583.0	35									1.7	0.31	1.2	0.12				
666.2	40									2.0	0.40	1.3	0.15				
749.5	45									2.2	0.50	1.5	0.19				
832.8	50											1.6	0.23				
916.1	55											1.8	0.27				
999.3	60											2.0	0.32				
1082.6	65											2.1	0.37	1.0	0.05		
1165.9	70											2.3	0.42	1.1	0.06		
1249.2	75													1.1	0.07		
1332.5	80													1.2	0.08		
1415.7	85													1.3	0.09		
1499.0	90													1.4	0.10		
1665.6	100													1.5	0.12	1.0	0.04
1832.1	110													1.7	0.14	1.1	0.05
1998.7	120													1.8	0.17	1.2	0.06
2165.3	130													2.0	0.20	1.3	0.07
2331.8	140													2.1	0.23	1.4	0.08
2498.4	150													2.3	0.26	1.5	0.09

Notes: Shaded areas represent velocities over 1.5 m/s. Use with caution when water hammer is a concern.

FRICITION LOSS CHARTS - UPVC PIPE CLASS 4 (10 BAR)

C = 150 • PRESSURE LOSS (BAR/100 METRES)																					
Nominal Size		25 mm		32 mm		40 mm		50 mm		63 mm		75 mm		90 mm		110 mm		160 mm		200 mm	
Pipe ID		22 mm		28.4 mm		36.2 mm		45.2 mm		57 mm		67.8 mm		81.4 mm		99.4 mm		144.6 mm		180.8 mm	
Pipe OD		25 mm		32 mm		40 mm		50 mm		63 mm		75 mm		90 mm		110 mm		160 mm		200 mm	
Wall Thick		1.5 mm		1.8 mm		1.9 mm		2.4 mm		3.0 mm		3.6 mm		4.3 mm		5.3 mm		7.7 mm		9.6 mm	
Flow l/min	Flow m ³ /hr	Velocity m/s	bar loss	Velocity m/s	bar loss	Velocity m/s	bar loss	Velocity m/s	bar loss	Velocity m/s	bar loss	Velocity m/s	bar loss	Velocity m/s	bar loss	Velocity m/s	bar loss	Velocity m/s	bar loss	Velocity m/s	bar loss
3.8	0.25	0.2	0.02																		
7.6	0.5	0.4	0.08																		
11.4	0.75	0.5	0.18																		
15.1	1	0.7	0.30																		
26.5	1.5	1.1	0.64	0.7	0.19																
34.1	2	1.5	1.10	0.9	0.32																
41.6	2.5	1.8	1.66	1.1	0.48	0.7	0.15														
49.2	3	2.2	2.33	1.3	0.67	0.8	0.21														
56.8	3.5	2.6	3.10	1.5	0.89	0.9	0.27														
68.1	4			1.8	1.14	1.1	0.35	0.7	0.12												
83.3	5			2.2	1.73	1.3	0.53	0.9	0.18												
98.4	6			2.6	2.42	1.6	0.74	1.0	0.25	0.7	0.08										
117.3	7					1.9	0.99	1.2	0.34	0.8	0.11										
132.5	8					2.2	1.27	1.4	0.43	0.9	0.14										
151.4	9					2.4	1.58	1.6	0.53	1.0	0.17	0.7	0.07								
166.6	10							1.7	0.65	1.1	0.21	0.8	0.09								
181.7	11							1.9	0.77	1.2	0.25	0.8	0.11								
200.6	12							2.1	0.91	1.3	0.29	0.9	0.13								
215.8	13							2.3	1.06	1.4	0.34	1.0	0.15								
234.7	14							2.4	1.21	1.5	0.39	1.1	0.17								
249.8	15							2.6	1.38	1.6	0.44	1.2	0.19								
265.0	16									1.7	0.50	1.2	0.22	0.9	0.09						
283.9	17									1.9	0.56	1.3	0.24	0.9	0.10						
299.0	18									2.0	0.62	1.4	0.27	1.0	0.11						
318.0	19									2.1	0.69	1.5	0.30	1.0	0.12						
333.1	20									2.2	0.76	1.5	0.33	1.1	0.13						
348.3	21									2.3	0.83	1.6	0.36	1.1	0.15						
367.2	22									2.4	0.90	1.7	0.39	1.2	0.16						
382.3	23									2.5	0.98	1.8	0.42	1.2	0.17						
401.3	24											1.8	0.46	1.3	0.19						
416.4	25											1.9	0.49	1.3	0.20						
431.5	26											2.0	0.53	1.4	0.22	0.9	0.08				
450.5	27											2.1	0.57	1.4	0.23	1.0	0.09				
465.6	28											2.2	0.61	1.5	0.25	1.0	0.09				
484.5	29											2.2	0.65	1.5	0.27	1.0	0.10				
499.7	30											2.3	0.69	1.6	0.28	1.1	0.11	0.5	0.02		
583.0	35													1.9	0.38	1.3	0.14	0.6	0.02		
666.2	40													2.1	0.48	1.4	0.18	0.7	0.03		
749.5	45													2.4	0.60	1.6	0.23	0.8	0.04		
832.8	50															1.8	0.28	0.8	0.04		
916.1	55															2.0	0.33	0.9	0.05		
999.3	60															2.1	0.39	1.0	0.06		
1082.6	65															2.3	0.45	1.1	0.07		
1165.9	70															2.5	0.51	1.2	0.08		
1249.2	75															2.7	0.58	1.3	0.09		
1332.5	80															2.9	0.66	1.4	0.11		
1415.7	85															3.0	0.74	1.4	0.12		
1499.0	90															3.2	0.82	1.5	0.13	1.0	0.04
1665.6	100																	1.7	0.16	1.1	0.05
1832.1	110																	1.9	0.19	1.2	0.06
1998.7	120																	2.0	0.22	1.3	0.08
2165.3	130																	2.2	0.26	1.4	0.09
2331.8	140																	2.4	0.30	1.5	0.10
2498.4	150																	2.5	0.34	1.6	0.11

Notes: Shaded areas represent velocities over 1.5 m/s. Use with caution when water hammer is a concern.

FRICION LOSS CHARTS - UPVC PIPE CLASS 5 (16 BAR)

C = 150 • PRESSURE LOSS (BAR/100 METRES)

Nominal Size		25 mm		32 mm		40 mm		50 mm		63 mm		75 mm		90 mm		110 mm		160 mm		200 mm	
Pipe ID		21.2 mm		27.2 mm		34 mm		42.6 mm		53.6 mm		63.8 mm		76.6 mm		93.6 mm		136.2 mm		170.2 mm	
Pipe OD		25 mm		32 mm		40 mm		50 mm		63 mm		75 mm		90 mm		110 mm		160 mm		200 mm	
Wall Thick		1.5 mm		1.8 mm		1.9 mm		2.4 mm		3 mm		3.6 mm		4.3 mm		5.3 mm		7.7 mm		14.9 mm	
Flow l/min	Flow m ³ /hr	Velocity m/s	bar loss	Velocity m/s	bar loss	Velocity m/s	bar loss	Velocity m/s	bar loss	Velocity m/s	bar loss	Velocity m/s	bar loss	Velocity m/s	bar loss	Velocity m/s	bar loss	Velocity m/s	bar loss	Velocity m/s	bar loss
3.8	0.25	0.2	0.03																		
7.6	0.5	0.4	0.10																		
11.4	0.75	0.6	0.21	0.4	0.06																
15.1	1	0.8	0.36	0.5	0.11	0.3	0.04														
26.5	1.5	1.2	0.77	0.7	0.23	0.5	0.08	0.3	0.03												
34.1	2	1.6	1.32	1.0	0.39	0.6	0.13	0.4	0.04												
41.6	2.5	2.0	1.99	1.2	0.59	0.8	0.20	0.5	0.07												
49.2	3	2.4	2.79	1.4	0.83	0.9	0.28	0.6	0.09												
56.8	3.5			1.7	1.10	1.1	0.37	0.7	0.12												
68.1	4			1.9	1.41	1.2	0.48	0.8	0.16												
83.3	5			2.4	2.13	1.5	0.72	1.0	0.24												
98.4	6					1.8	1.01	1.2	0.34	0.7	0.11										
117.3	7					2.1	1.34	1.4	0.45	0.9	0.15										
132.5	8					2.4	1.72	1.6	0.57	1.0	0.19										
151.4	9							1.8	0.71	1.1	0.23										
166.6	10							1.9	0.87	1.2	0.28										
181.7	11							2.1	1.03	1.4	0.34	1.0	0.14								
200.6	12							2.3	1.21	1.5	0.40	1.0	0.17								
215.8	13									1.6	0.46	1.1	0.20								
234.7	14									1.7	0.53	1.2	0.23								
249.8	15									1.8	0.60	1.3	0.26								
265.0	16									2.0	0.68	1.4	0.29	1.0	0.12						
283.9	17									2.1	0.76	1.5	0.32	1.0	0.13						
299.0	18									2.2	0.84	1.6	0.36	1.1	0.15						
318.0	19									2.3	0.93	1.7	0.40	1.1	0.16						
333.1	20									2.5	1.02	1.7	0.44	1.2	0.18						
348.3	21											1.8	0.48	1.3	0.20						
367.2	22											1.9	0.52	1.3	0.21						
382.3	23											2.0	0.57	1.4	0.23						
401.3	24											2.1	0.61	1.4	0.25	1.0	0.09				
416.4	25											2.2	0.66	1.5	0.27	1.0	0.10				
431.5	26											2.3	0.71	1.6	0.29	1.0	0.11				
450.5	27											2.3	0.76	1.6	0.31	1.1	0.12				
465.6	28											2.4	0.82	1.7	0.33	1.1	0.13				
484.5	29											2.5	0.87	1.7	0.36	1.2	0.13				
499.7	30													1.8	0.38	1.2	0.14				
583.0	35													2.1	0.51	1.4	0.19				
666.2	40													2.4	0.65	1.6	0.24				
749.5	45													2.7	0.81	1.8	0.30				
832.8	50															2.0	0.37	1.0	0.06		
916.1	55															2.2	0.44	1.0	0.07		
999.3	60															2.4	0.52	1.1	0.08		
1082.6	65															2.6	0.60	1.2	0.10		
1165.9	70															2.8	0.69	1.3	0.11		
1249.2	75															3.0	0.78	1.4	0.13		
1332.5	80															3.2	0.88	1.5	0.14		
1415.7	85																	1.6	0.16		
1499.0	90																	1.7	0.18		
1665.6	100																	1.9	0.21	1.2	0.07
1832.1	110																	2.1	0.26	1.3	0.09
1998.7	120																	2.3	0.30	1.5	0.10
2165.3	130																	2.5	0.35	1.6	0.12
2331.8	140																	2.7	0.40	1.7	0.14
2498.4	150																	2.9	0.45	1.8	0.15

Notes: Shaded areas represent velocities over 1.5 m/s. Use with caution when water hammer is a concern.

FRICITION LOSS CHARTS - SCHEDULE 40 IPS PVC PLASTIC PIPE

C = 150 • PRESSURE LOSS (BAR/100 METRES)																			
Nominal Size		1"		1¼"		1½"		2"		2½"		3"		4"		6"		8"	
Pipe OD		1.315"		1.66"		1.900"		2.375"		2.375"		3.500"		4.500"		6.625"		8.625"	
Pipe ID		1.049"		1.380"		1.610"		2.067"		2.469"		3.068"		4.026"		6.065"		7.981"	
Pipe ID mm		26.64		35.05		40.89		52.50		62.71		77.93		102.26		154.05		202.72	
Wall Thick		0.133"		0.140"		0.145"		0.154"		0.203"		0.216"		0.237"		0.280"		0.322"	
Flow l/min	Flow m³/hr	Velocity m/s	bar loss	Velocity m/s	bar loss	Velocity m/s	bar loss	Velocity m/s	bar loss	Velocity m/s	bar loss	Velocity m/s	bar loss	Velocity m/s	bar loss	Velocity m/s	bar loss	Velocity m/s	bar loss
3.8	0.25	0.1	0.01																
7.6	0.5	0.2	0.03																
11.4	0.75	0.4	0.07	0.2	0.02														
15.1	1	0.5	0.12	0.3	0.03	0.2	0.01												
26.5	1.5	0.7	0.25	0.4	0.07	0.3	0.03	0.2	0.01										
34.1	2	1.0	0.43	0.6	0.11	0.4	0.05	0.3	0.02										
41.6	2.5	1.2	0.65	0.7	0.17	0.5	0.08	0.3	0.02										
49.2	3	1.5	0.92	0.9	0.24	0.6	0.11	0.4	0.03										
56.8	3.5	1.7	1.22	1.0	0.32	0.7	0.15	0.4	0.04										
68.1	4	2.0	1.56	1.2	0.41	0.8	0.19	0.5	0.06										
83.3	5	2.5	2.36	1.4	0.62	1.1	0.29	0.6	0.09										
98.4	6			1.7	0.87	1.3	0.41	0.8	0.12	0.5	0.05	0.3	0.02						
117.3	7			2.0	1.16	1.5	0.55	0.9	0.16	0.6	0.07	0.4	0.02						
132.5	8			2.3	1.48	1.7	0.70	1.0	0.21	0.7	0.09	0.5	0.03						
151.4	9			2.6	1.84	1.9	0.87	1.2	0.26	0.8	0.11	0.5	0.04						
166.6	10			2.9	2.24	2.1	1.06	1.3	0.31	0.9	0.13	0.6	0.05						
181.7	11					2.3	1.26	1.4	0.37	1.0	0.16	0.6	0.05						
200.6	12					2.5	1.48	1.5	0.44	1.1	0.18	0.7	0.06						
215.8	13					2.7	1.72	1.7	0.51	1.2	0.21	0.8	0.07						
234.7	14					3.0	1.97	1.8	0.58	1.3	0.25	0.8	0.09						
249.8	15					3.2	2.24	1.9	0.66	1.3	0.28	0.9	0.10						
265.0	16							2.1	0.75	1.4	0.31	0.9	0.11						
283.9	17							2.2	0.84	1.5	0.35	1.0	0.12						
299.0	18							2.3	0.93	1.6	0.39	1.0	0.14						
318.0	19							2.4	1.03	1.7	0.43	1.1	0.15						
333.1	20							2.6	1.13	1.8	0.48	1.2	0.17						
348.3	21									1.9	0.52	1.2	0.18						
367.2	22									2.0	0.57	1.3	0.20						
382.3	23									2.1	0.62	1.3	0.21						
401.3	24									2.2	0.67	1.4	0.23						
416.4	25									2.2	0.72	1.5	0.25						
431.5	26									2.3	0.77	1.5	0.27						
450.5	27									2.4	0.83	1.6	0.29						
465.6	28											1.6	0.31						
484.5	29											1.7	0.33						
499.7	30											1.7	0.35						
583.0	35											2.0	0.47	1.2	0.12				
666.2	40											2.3	0.60	1.4	0.16				
749.5	45											2.6	0.74	1.5	0.20				
832.8	50											2.9	0.90	1.7	0.24				
916.1	55													1.9	0.29				
999.3	60													2.0	0.34				
1082.6	65													2.2	0.39	1.0	0.07		
1165.9	70													2.4	0.45	1.0	0.08		
1249.2	75													2.5	0.51	1.1	0.09		
1332.5	80													2.7	0.57	1.2	0.10		
1415.7	85													2.9	0.64	1.3	0.11		
1499.0	90													3.0	0.71	1.3	0.12	0.8	0.03
1665.6	100															1.5	0.15	0.9	0.03
1832.1	110															1.6	0.18	0.9	0.04
1998.7	120															1.8	0.21	1.0	0.04
2165.3	130															1.9	0.25	1.1	0.05
2331.8	140															2.1	0.28	1.2	0.06
2498.4	150															2.1	0.32	1.3	0.07

Notes: Shaded areas represent velocities over 1.5 m/s. Use with caution when water hammer is a concern.

FRICION LOSS CHARTS - SCHEDULE 80 IPS PVC PLASTIC PIPE

C = 150 • PRESSURE LOSS (BAR/100 METRES)

Nominal Size		1"		1¼"		1½"		2"		2½"		3"		4"		6"		8"	
Pipe OD		1.315"		1.660"		1.900"		2.375"		2.875"		3.500"		4.500"		6.625"		8.625"	
Pipe ID		0.957"		1.278"		1.500"		1.939"		2.323"		2.900"		3.826"		5.761"		7.625"	
Pipe ID mm		24.31		32.46		38.10		49.25		59.00		73.66		97.18		146.33		193.68	
Wall Thick		0.179"		0.191"		0.200"		0.218"		0.276"		0.300"		0.337"		0.432"		0.500"	
Flow l/min	Flow m³/hr	Velocity m/s	bar loss	Velocity m/s	bar loss	Velocity m/s	bar loss	Velocity m/s	bar loss	Velocity m/s	bar loss	Velocity m/s	bar loss	Velocity m/s	bar loss	Velocity m/s	bar loss	Velocity m/s	bar loss
3.8	0.25	0.1	0.01																
7.6	0.5	0.3	0.05																
11.4	0.75	0.4	0.11	0.3	0.03														
15.1	1	0.6	0.19	0.3	0.05	0.2	0.02												
26.5	1.5	0.9	0.40	0.5	0.10	0.4	0.04	0.2	0.01										
34.1	2	1.2	0.68	0.7	0.17	0.5	0.08	0.3	0.02										
41.6	2.5	1.5	1.02	0.8	0.25	0.6	0.11	0.4	0.03										
49.2	3	1.8	1.43	1.0	0.35	0.7	0.16	0.4	0.05										
56.8	3.5	2.1	1.90	1.2	0.47	0.9	0.21	0.5	0.06										
68.1	4	2.4	2.44	1.3	0.60	1.0	0.27	0.6	0.08										
83.3	5	3.0	3.69	1.7	0.90	1.2	0.41	0.7	0.12										
98.4	6			2.0	1.26	1.5	0.58	0.9	0.17	0.6	0.07	0.4	0.02						
117.3	7			2.3	1.68	1.7	0.77	1.0	0.22	0.7	0.09	0.5	0.03						
132.5	8			2.7	2.15	1.9	0.99	1.2	0.28	0.8	0.12	0.5	0.04						
151.4	9			3.0	2.68	2.2	1.23	1.3	0.35	0.9	0.15	0.6	0.05						
166.6	10					2.4	1.49	1.5	0.43	1.0	0.18	0.7	0.06						
181.7	11					2.7	1.78	1.6	0.51	1.1	0.21	0.7	0.07						
200.6	12					2.9	2.09	1.7	0.60	1.2	0.25	0.8	0.08						
215.8	13							1.9	0.69	1.3	0.29	0.8	0.10						
234.7	14							2.0	0.80	1.4	0.33	0.9	0.11						
249.8	15							2.2	0.91	1.5	0.38	1.0	0.13						
265.0	16							2.3	1.02	1.6	0.42	1.0	0.14						
283.9	17							2.5	1.14	1.7	0.47	1.1	0.16						
299.0	18							2.6	1.27	1.8	0.53	1.2	0.18						
318.0	19									1.9	0.58	1.2	0.20						
333.1	20									2.0	0.64	1.3	0.22						
348.3	21									2.1	0.70	1.4	0.24						
367.2	22									2.2	0.76	1.4	0.26						
382.3	23									2.3	0.83	1.5	0.28						
401.3	24									2.4	0.90	1.6	0.30						
416.4	25									2.5	0.97	1.6	0.33						
431.5	26											1.7	0.35						
450.5	27											1.8	0.38						
465.6	28											1.8	0.41	1.0	0.11				
484.5	29											1.9	0.43	1.1	0.11				
499.7	30											2.0	0.46	1.1	0.12				
583.0	35											2.3	0.61	1.3	0.16				
666.2	40											2.6	0.78	1.5	0.20				
749.5	45													1.7	0.25				
832.8	50													1.9	0.31				
916.1	55													2.1	0.37				
999.3	60													2.2	0.43				
1082.6	65													2.4	0.50	1.1	0.07		
1165.9	70													2.6	0.57	1.2	0.08		
1249.2	75													2.8	0.65	1.2	0.09		
1332.5	80													3.0	0.73	1.3	0.10		
1415.7	85													3.2	0.82	1.4	0.11		
1499.0	90													3.4	0.91	1.5	0.12		
1665.6	100															1.7	0.15	0.9	0.04
1832.1	110															1.8	0.18	1.0	0.05
1998.7	120															2.0	0.21	1.1	0.05
2165.3	130															2.1	0.25	1.2	0.06
2331.8	140															2.3	0.28	1.3	0.07
2498.4	150															2.5	0.32	1.4	0.08

Notes: Shaded areas represent velocities over 1.5 m/s. Use with caution when water hammer is a concern.

FRICION LOSS CHARTS - HDPE PRESSURE PIPE PE80 SDR 17.6 PN6

C = 140 • PRESSURE LOSS (BAR/100 METRES)																						
Nominal Size Pipe ID mm Wall Thick		25 mm 21.40 1.8		32 mm 28.40 1.8		40 mm 35.40 2.3		50 mm 44.20 2.9		63 mm 55.80 3.6		75 mm 66.40 4.3		90 mm 79.80 5.1		110 mm 97.40 6.3		160 mm 141.80 9.1		200 mm 177.20 11.4		
Flow l/min	Flow m ³ /hr	Velocity m/s	bar loss	Velocity m/s	bar loss	Velocity m/s	bar loss	Velocity m/s	bar loss	Velocity m/s	bar loss	Velocity m/s	bar loss	Velocity m/s	bar loss	Velocity m/s	bar loss	Velocity m/s	bar loss	Velocity m/s	bar loss	
3.8	0.25	0.2	0.03																			
7.6	0.5	0.4	0.11																			
11.4	0.75	0.6	0.23	0.3	0.06																	
15.1	1	0.8	0.40	0.4	0.10	0.3	0.03															
26.5	1.5	1.2	0.84	0.7	0.21	0.4	0.07	0.3	0.02													
34.1	2	1.5	1.43	0.9	0.36	0.6	0.12	0.4	0.04													
41.6	2.5	1.9	2.16	1.1	0.54	0.7	0.19	0.5	0.06													
49.2	3	2.3	3.03	1.3	0.76	0.8	0.26	0.5	0.09													
56.8	3.5	2.7	4.03	1.5	1.01	1.0	0.35	0.6	0.12													
68.1	4	3.1	5.16	1.8	1.30	1.1	0.44	0.7	0.15													
83.3	5			2.2	1.96	1.4	0.67	0.9	0.23													
98.4	6			2.6	2.75	1.7	0.94	1.1	0.32	0.7	0.10	0.5	0.04									
117.3	7			3.1	3.66	2.0	1.25	1.3	0.42	0.8	0.14	0.6	0.06									
132.5	8			3.5	4.69	2.3	1.60	1.4	0.54	0.9	0.17	0.6	0.07									
151.4	9					2.5	2.00	1.6	0.68	1.0	0.22	0.7	0.09									
166.6	10					2.8	2.43	1.8	0.82	1.1	0.26	0.8	0.11									
181.7	11							2.0	0.98	1.2	0.32	0.9	0.14									
200.6	12							2.2	1.15	1.4	0.37	1.0	0.16									
215.8	13							2.4	1.34	1.5	0.43	1.0	0.18									
234.7	14							2.5	1.53	1.6	0.49	1.1	0.21									
249.8	15							2.7	1.74	1.7	0.56	1.2	0.24									
265.0	16							2.9	1.96	1.8	0.63	1.3	0.27									
283.9	17							3.1	2.20	1.9	0.71	1.4	0.30									
299.0	18							3.3	2.44	2.0	0.79	1.4	0.34									
318.0	19									2.2	0.87	1.5	0.37									
333.1	20									2.3	0.95	1.6	0.41									
348.3	21									2.4	1.04	1.7	0.45	1.2	0.18							
367.2	22									2.5	1.14	1.8	0.49	1.2	0.20							
382.3	23									2.6	1.24	1.8	0.53	1.3	0.22							
401.3	24									2.7	1.34	1.9	0.57	1.3	0.23							
416.4	25									3.8	1.44	2.0	0.62	1.4	0.25							
431.5	26											2.1	0.67	1.4	0.27	1.0	0.10	0.5	0.02			
450.5	27											2.2	0.71	1.5	0.29	1.0	0.11	0.5	0.02			
465.6	28											2.2	0.76	1.6	0.31	1.0	0.12	0.5	0.02			
484.5	29											2.3	0.81	1.6	0.33	1.1	0.13	0.5	0.02			
499.7	30											2.4	0.87	1.7	0.35	1.1	0.13	0.5	0.02			
583.0	35											2.8	1.15	1.9	0.47	1.3	0.18	0.6	0.03			
666.2	40											3.2	1.48	2.2	0.60	1.5	0.23	0.7	0.04			
749.5	45													2.5	0.75	1.7	0.28	0.8	0.05			
832.8	50													2.8	0.91	1.9	0.35	0.9	0.06			
916.1	55													3.1	1.09	2.1	0.41	1.0	0.07			
999.3	60													3.3	1.28	2.2	0.48	1.1	0.08			
1082.6	65															2.4	0.56	1.1	0.09			
1165.9	70															2.6	0.64	1.2	0.10			
1249.2	75																	1.3	0.12			
1332.5	80																	1.4	0.13			
1415.7	85																	1.5	0.15			
1499.0	90																	1.6	0.16			
1665.6	100																	1.8	0.20	1.1	0.07	
1832.1	110																	1.9	0.24	1.2	0.08	
1998.7	120																	2.1	0.28	1.4	0.09	
2165.3	130																	2.3	0.33	1.5	0.11	
2331.8	140																			1.6	0.13	
2498.4	150																			1.7	0.14	

Notes: Shaded areas represent velocities over 1.5 m/s. Use with caution when water hammer is a concern.

FRICION LOSS CHARTS - HDPE PRESSURE PIPE PE80 SDR 11 PN10

C = 140 • PRESSURE LOSS (BAR/100 METRES)

Nominal Size Pipe ID mm Wall Thick		25 mm 20.40 2.3		32 mm 26.20 2.9		40 mm 32.60 3.7		50 mm 40.80 4.6		63 mm 51.40 5.8		75 mm 61.40 6.8		90 mm 73.60 8.2		110 mm 90.00 10		160 mm 130.80 14.6		200 mm 163.60 18.2	
Flow l/min	Flow m ³ /hr	Velocity m/s	bar loss	Velocity m/s	bar loss	Velocity m/s	bar loss	Velocity m/s	bar loss	Velocity m/s	bar loss	Velocity m/s	bar loss	Velocity m/s	bar loss	Velocity m/s	bar loss	Velocity m/s	bar loss	Velocity m/s	bar loss
3.8	0.25	0.2	0.04																		
7.6	0.5	0.4	0.14																		
11.4	0.75	0.6	0.29	0.4	0.09																
15.1	1	0.8	0.50	0.5	0.15																
26.5	1.5	1.3	1.06	0.8	0.31	0.5	0.11														
34.1	2	1.7	1.80	1.0	0.53	0.7	0.18														
41.6	2.5	2.1	2.73	1.3	0.81	0.8	0.28	0.5	0.09												
49.2	3	2.5	3.82	1.5	1.13	1.0	0.39	0.6	0.13												
56.8	3.5	3.0	5.08	1.8	1.50	1.2	0.52	0.7	0.17												
68.1	4			2.1	1.92	1.3	0.66	0.8	0.22	0.5	0.07										
83.3	5			2.6	2.91	1.7	1.00	1.1	0.34	0.7	0.11										
98.4	6			3.1	4.08	2.0	1.41	1.3	0.47	0.8	0.15										
117.3	7					2.3	1.87	1.5	0.63	0.9	0.20										
132.5	8					2.7	2.40	1.7	0.8	1.1	0.26										
151.4	9					3.0	2.98	1.9	1.00	1.2	0.32										
166.6	10							2.1	1.21	1.3	0.39										
181.7	11							2.3	1.45	1.5	0.47	1.0	0.20								
200.6	12							2.5	1.70	1.6	0.55	1.1	0.23								
215.8	13							2.8	1.97	1.7	0.64	1.2	0.27								
234.7	14							3.0	2.27	1.9	0.74	1.3	0.31								
249.8	15									2.0	0.84	1.4	0.35								
265.0	16									2.1	0.94	1.5	0.40								
283.9	17									2.3	1.05	1.6	0.44	1.1	0.18						
299.0	18									2.4	1.17	1.7	0.49	1.2	0.20						
318.0	19									2.5	1.30	1.8	0.54	1.2	0.23						
333.1	20									2.7	1.42	1.9	0.60	1.3	0.25						
348.3	21									2.8	1.56	2.0	0.66	1.4	0.27						
367.2	22									2.9	1.70	2.1	0.71	1.4	0.30						
382.3	23									3.1	1.84	2.2	0.78	1.5	0.32						
401.3	24											2.3	0.84	1.6	0.35						
416.4	25											2.3	0.91	1.6	0.37						
431.5	26											2.4	0.97	1.7	0.40	1.1	0.15				
450.5	27											2.5	1.04	1.8	0.43	1.2	0.16				
465.6	28											2.6	1.12	1.8	0.46	1.2	0.17				
484.5	29											2.7	1.19	1.9	0.49	1.3	0.19				
499.7	30											2.8	1.27	2.0	0.53	1.3	0.20				
583.0	35											3.3	1.69	2.3	0.70	1.5	0.26				
666.2	40													2.6	0.89	1.7	0.34				
749.5	45													2.9	1.11	2.0	0.42				
832.8	50													3.3	1.35	2.2	0.51	1.0	0.08		
916.1	55															2.4	0.61	1.1	0.10		
999.3	60															2.6	0.71	1.2	0.12		
1082.6	65															2.8	0.83	1.3	0.13		
1165.9	70															3.1	0.95	1.4	0.15		
1249.2	75															3.3	1.08	1.6	0.17		
1332.5	80																	1.7	0.20		
1415.7	85																	1.8	0.22	1.1	0.07
1499.0	90																	1.9	0.24	1.2	0.08
1665.6	100																	2.1	0.30	1.3	0.10
1832.1	110																	2.3	0.35	1.5	0.12
1998.7	120																	2.5	0.42	1.6	0.14
2165.3	130																	2.7	0.48	1.7	0.16
2331.8	140																			1.8	0.19
2498.4	150																			2.0	0.21

Notes: Shaded areas represent velocities over 1.5 m/s. Use with caution when water hammer is a concern.

PRESSURE LOSS CHARTS

TABLE OF APPROXIMATE PRESSURE LOSSES FOR PIPE FITTINGS

Steel Fitting Type	½"	¾"	1" (25 mm)	1¼" (30 mm)	1½" (40 mm)	2" (50 mm)	2½" (65 mm)	3" (80 mm)	4" (100 mm)	6" (150 mm)	8" (200 mm)
Coupling	0.18	0.24	0.30	0.37	0.46	0.61	0.76	0.91	1.21	1.82	2.40
Run of St. Tee	0.30	0.30	4.60	0.60	0.60	0.76	0.91	1.21	1.52	2.13	3.05
Tee, Side Outlet	0.91	1.38	1.50	2.13	2.74	3.35	4.0	4.90	6.1	9.44	12.1
Tee, Run Reduced ½"	0.45	0.76	0.91	1.21	1.50	1.82	2.13	2.4	3.65	4.90	6.10
Elbow, 90°	0.45	0.76	0.91	1.21	1.50	1.82	2.13	2.4	3.65	4.90	6.10
Elbow, 45°	0.22	0.30	0.40	0.52	0.60	0.76	0.91	1.06	1.5	2.28	3.04
Corporation Stop	2.74	2.74	2.74	2.74	2.74	2.74					
Curb Stop	1.82	1.82	2.13	2.13	2.43	2.43					

Plastic IPS or Copper Fitting Type	½"	¾"	1" (25 mm)	1¼" (30 mm)	1½" (40 mm)	2" (50 mm)	2½" (65 mm)	3" (80 mm)	4" (100 mm)	6" (150 mm)	8" (200 mm)
Coupling	0.46	0.76	0.91	0.91	1.22	1.82	2.13	2.43	3.35	5.50	7.31
Run of St. Tee	0.76	0.91	1.22	1.52	1.83	2.43	2.74	3.35	4.57	6.40	8.53
Tee, Side Outlet	2.13	2.74	3.65	4.57	5.48	7.31	9.14	11.0	13.71	21.33	27.43
Tee, Run Reduced ½"	1.06	1.37	1.82	2.43	2.74	3.35	4.26	5.18	7.31	10.36	13.71
Elbow, 90°	1.06	1.37	1.82	2.43	2.74	3.35	4.26	5.18	7.31	10.36	13.71
Elbow, 34°	0.46	0.60	0.91	1.06	1.22	1.52	2.13	2.44	3.04	4.90	6.10

Note:

It is recommended that the charts above only be used when the manufacturer's recommended pressure loss values are not available.

ACCESSORY PRESSURE LOSS CHARTS

HCV PRESSURE LOSS CHART

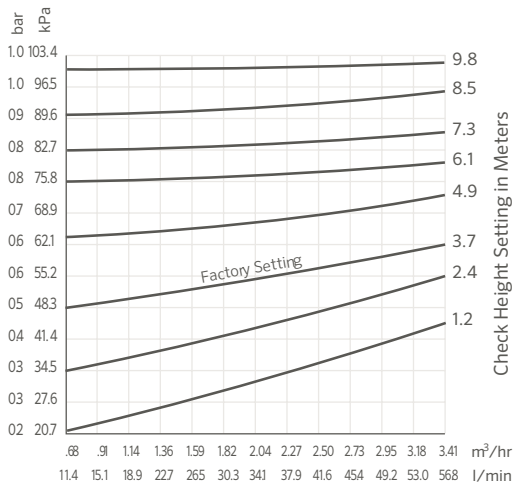

SWING JOINT FRICTION LOSS

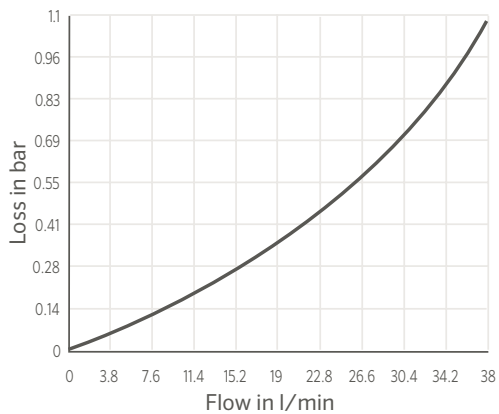

PRESSURE LOSS CHARTS

**BTT 1-ZONE Inlet Size 3/4",
Flow Rate 3-27 l/min**

l/min	Friction Loss
3	0.3 (28)
7	0.3 (34)
11	0.4 (41)
15	0.6 (55)
19	0.8 (76)
23	1 (103)
27	1 (138)

Note:
Maximum flow at 3.4 bar (340kPa)

**BTT 2-ZONE Inlet Size 3/4",
Flow Rate 3-27 l/min**

l/min	Friction Loss
3	0.1 (14)
7	0.2 (21)
11	0.3 (34)
15	0.5 (48)
19	0.7 (69)
23	1 (69)
27	1 (124)

Note:
Maximum flow at 3.4 bar (340kPa)
Data shows one 1-zone running at a time

For applications requiring higher efficiency and lower friction loss, use Hunter valves and dripline products.

HC FLOW METER Pressure Loss Chart

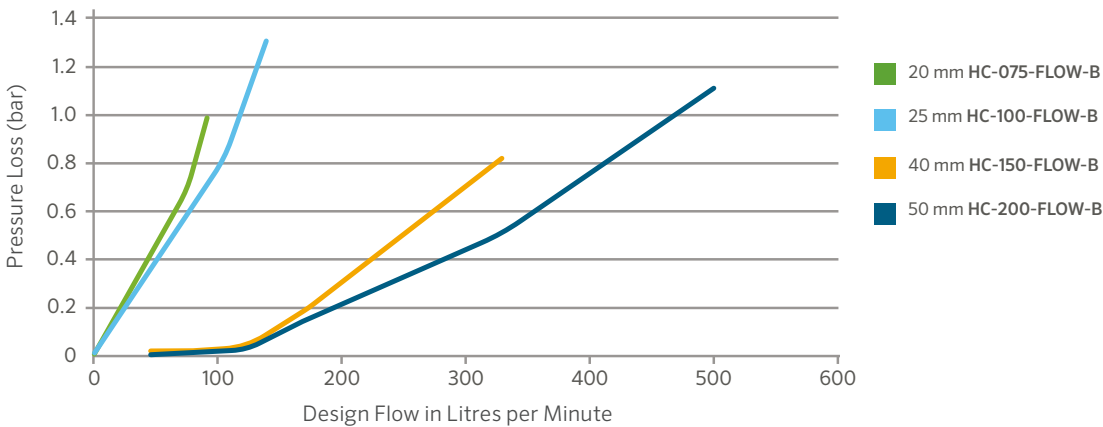

WIRE DATA

STANDARD ANNEALED COPPER AT 20°C						
American Wire Gauge	Common Metric Equivalent (mm ²)	Diameter (mils)	Diameter (mm)	Cross-Sectional Area (mm ²)	Resistance (Per mft ohms)	Resistance (per km ohms)
1	50	289.3	7.348	42.4	0.924	0.407
2	35	257.6	6.543	33.6	0.156	0.513
3		229.4	5.827	26.7	0.197	0.647
4	25	204.3	5.189	21.1	0.249	0.815
5		181.9	4.62	16.8	0.313	1.028
6	16	162	4.115	13.3	0.395	1.297
7		144.3	3.665	10.6	0.498	1.634
8	10	128.5	3.264	8.36	0.628	2.061
9		114.4	2.906	6.63	0.793	2.6
10	6	101.9	2.588	5.26	0.999	3.277
11		90.7	2.3	4.17	1.26	4.14
12	4	80.8	2.05	3.31	1.59	5.21
13		72	1.83	2.63	2	6.56
14	2.5	64.1	1.63	1.63	2.52	8.28
15		57.1	1.45	1.65	3.18	10.4
16	1.5	50.8	1.29	1.31	4.02	13.2
17		45.3	1.15	1.04	5.05	16.6
18	0.75	40.3	1.02	0.82	6.39	21
19		35.9	0.912	0.65	8.05	26.4
20	0.5	32	0.813	0.52	10.1	33.2

PSR WIRE DATA

MAXIMUM WIRE LENGTH, ONE WAY						
Model	0.75 mm ²	1.5 mm ²	2.5 mm ²	4 mm ²	6 mm ²	10 mm ²
PSR-22	74 m	118 m	188 m	298 m	473 m	751 m
PSR-52	41 m	65 m	104 m	165 m	262 m	416 m
PSR-53	41 m	65 m	104 m	165 m	262 m	416 m

WIRE SIZING

REQUIRED INFORMATION

- 1) Actual one-way length of wire between the controllers and the power source or the controllers and valves
- 2) Allowable voltage loss along the wire circuit
- 3) Accumulative current flowing through the wire section being sized in amperes

RESISTANCE IS CALCULATED USING THIS FORMULA:

$$R = \frac{1,000 \times AVL}{2L \times I}$$

R = Maximum allowable resistance of wire in ohms per 1,000 m

AVL = Allowable voltage loss

L = Wire length (one way)

I = Inrush current

AVL for controller power wire sizing is calculated by subtracting the minimum operating voltage required by the controller from the minimum available voltage at the power source.

AVL for valve wire sizing is calculated by subtracting minimum solenoid operating voltage from controller output voltage.

This number will vary depending on the manufacturer and in some cases with line pressure.

VALVE WIRE SIZING EXAMPLE

Given: The distance from the controller to the valve is 600 m. The controller output is 24 V. The valve has a minimum operating voltage of 20 V and an inrush current of 370 mA (0.37 A).

$$R = \frac{1,000 \times 4}{2(600) \times 0.37}$$

$$R = \frac{4,000}{444}$$

$$R = 9.01 \text{ ohms/1,000 m}$$

So, wire resistance cannot exceed 9 ohms per 1,000 m. Now go to table #1 and select the proper wire size. Since 1.5 mm² gauge wire has more resistance than 9 ohms per 1,000 m, choose 2.5 mm² wire.

Table 2 is a quick reference and is set up to provide maximum wire runs given the information at the bottom of the table.

TABLE 1 - RESISTANCE OF COPPER WIRE		TABLE 2 - ALLOWABLE DISTANCES FOR VARIOUS WIRE SIZES*						
Wire Size (mm ²)	Resistance in Ohms per 1,000 m at 20° C	Ground Wire (mm ²)	0.5	1.0	Control Wire (mm ²)			
					1.5	2.5	4.0	6.0
0.5	34.5	0.5	157	209	235	261	279	289
1.0	17.2	1.0	209	314	377	449	503	538
1.5	11.5	1.5	235	377	470	588	684	754
2.5	6.9	2.5	261	449	588	783	965	1103
4.0	4.3	4.0	279	503	684	965	1,257	1,502
6.0	2.9	6.0	289	538	751	1,103	1,502	1,864

Notes:

Maximum one-way distance in metres between controller and solenoid assuming 370 mA inrush current, AVL = 4 volts, 1 valve on at a time

Table 2 is for a single active solenoid. With two solenoids operating simultaneously on the same wires, the wire distances should be halved.

DC-LATCHING SOLENOID

KEY BENEFITS

- Compatible with all Hunter irrigation valves
- Compatible with NODE, NODE-BT, and XC Hybrid
- Captive plunger offers easy servicing of solenoid
- Manual quarter-turn on/off control

OPERATING SPECIFICATIONS

- Minimum opening/operating voltage: 6 VDC
- Maximum recommended voltage: 9 VDC
- Coil resistance: 4.8 ohms nominal
- Pulse width: 250 milliseconds
- Wire leads: 45 cm of 0.8 mm² black/red UL-approved wire

Note: See controller product pages for wiring distances



DC-Latching Solenoid

(P/N 458200)

One black (common) wire and one red (station) wire

For AC Solenoid specifications, see Valve product pages starting on **Page 89**

ADDITIONAL DATA

WIRE SIZE REFERENCE CHART

Wire Size (mm ²)	25 mm	32 mm	40 mm	50 mm	63 mm	75 mm	90 mm	110 mm	160 mm	Wire Size (mm ²)
0.5	20	35	49	80	110	175	-	-	-	0.5
1	16	30	42	67	97	150	-	-	-	1
1.5	10	18	25	40	56	88	120	150	-	1.5
2.5	7	15	20	33	50	75	102	130	-	2.5
4	6	13	16	27	40	63	85	110	-	4
6	4	6	9	16	25	35	50	65	150	6

Notes:

Approximate number of wires to be installed in conduit or tubing. Maximum number of wires in conduit or sleeving.

CLIMATE ET_p TABLE

Climate*	mm Daily
Cool Humid	2.5 to 3.8
Cool Dry	3.8 to 5.1
Warm Humid	3.8 to 5.1
Warm Dry	5.1 to 6.3
Hot Humid	5.1 to 7.6
Hot Dry	7.6 to 11.4

Notes:

* Cool = under 21°C as an average midsummer high

* Warm = between 21° and 32°C as midsummer highs

* Hot = over 32°C

* Humid = over 50% as average midsummer relative humidity (dry = under 50%)

STATEMENT OF WARRANTY

Hunter Residential and Commercial Irrigation Products

Hunter Industries Incorporated (“Hunter”) warrants the following products to be free of defects in materials or workmanship under normal use in landscape irrigation applications for the specified period of time outlined below from the original date of manufacture:

ONE YEAR	ROTORS	SRM	MICRO	Micro Sprays, PLD Fittings, Rigid Risers, Air Relief Valves, RZB
TWO YEARS	ROTORS	PGP-ADJ, PGJ, HCV	CONTROLLERS	ACC (Legacy), BTT, Eco Logic, HC, HCC, HPC, I-Core/DUAL Families (Legacy), NODE, NODE-BT, Pro-C Families, Pro-HC, PSR, ROAM, X2, X-Core, XC Hybrid, WAND
	SPRAYS	PS Ultra Family, SJ, FLEXsg, HSBE Family	SENSORS	HC Flow Meter (wired and wireless)
	NOZZLES	Spray Nozzles, PCN, PCB, AFB, MSBN	MICRO	ACZ, PCZ, RZWS, Point Source Emitters, Tubing, Multi-Port Emitters, IH Risers, MLD, Eco-Indicator, Multi-Purpose Box, Senninger Regulators, PLD-LOC Fittings
	VALVES	PGV Family	TOOLS	SpotShot
	CENTRAL	IMMS Central Control Products (Legacy), A2C-WIFI, A2C-LAN, A2C-CELL-E, WIFIKIT, LANKIT, CELLKIT		
THREE YEARS	CONTROLLERS	ROAM XL, EZ Decoder System, EZ-DT	MP ROTATOR	All
FIVE YEARS	ROTORS	PGP Ultra, I-20, I-25, I-40, I-50, I-80, and I-90 Families	CONTROLLERS	ACC2, ICC2, ICD Decoders, ICD-HP
	SPRAYS	Pro-Spray, Pro-Spray PRS30, and Pro-Spray PRS40 Families	SENSORS	Clik Sensors, Flow-Sync, MWS, Solar Sync, Wireless Flow Sensor
	VALVES	HQ, ICV, IBV	MICRO	ICZ, PLD, HDL, HDL-COP**, Eco-Mat, Eco-Wrap

Hunter Golf and ST System Irrigation Products*

Hunter will unconditionally repair, replace, or repurchase, at its sole discretion, any defective component* assemblies contained within the Golf and ST products listed below by category, returned freight prepaid, from the date of manufacture within a period of:

ONE YEAR	GOLF CONTROLLERS	Pilot Command Center Software, Pilot-FC, Pilot-FI, Pilot Hub
THREE YEARS	GOLF ROTORS	TTS-800 Series, G-800 Series, G-900 Series, B Series
	GOLF TWO-WAY MODULES	Pilot 100, Pilot 200, Pilot 400, Pilot 600
FIVE YEARS	GOLF ROTORS	The golf rotor component warranty is extended to 5 years with a one-for-one purchase of an HSJ Swing Joint from an authorised Hunter Golf distributor.
	SWING JOINTS	HSJ-0, HSJ-1, HSJ-2, HSJ-3
	ST ROTORS	ST-90, STG-900, ST-1200, ST-1600, ST-1700
	ST ACCESSORIES	All models starting with “ST”
	COMPUTER, PRINTERS & ACCESSORIES, MAINTENANCE RADIO & BATTERY	Equipment manufacturer’s warranty (no Hunter warranty)

* Warranty covers repair, replacement, or repurchase of individual defective component assemblies contained within the product. Returns of complete finished goods are not allowed under warranty without prior approval from the Hunter Product Manager.

If used for agricultural applications, Hunter limits the warranty for its spray, rotator, and rotor products to a period of one (1) year from the original date of manufacture. This agriculture limitation supersedes all other warranties expressed or implied.

**While the use of copper does not completely remove the chance of root intrusion, it has been shown to assist in its prevention when coupled with proper irrigation scheduling.



Statement of Warranty, Continued

If a defect in a Hunter product is discovered during the applicable warranty period, Hunter will repair or replace, at its option, the product or the defective part. This warranty does not extend to repairs, adjustments, or replacement of a Hunter product or part that results from misuse, negligence, alteration, modification, tampering, or improper installation and/or maintenance of the product. This warranty extends only to the original installer of the Hunter product. If a defect arises in a Hunter product during the warranty period, contact your local Hunter Authorised Distributor.

Hunter's warranty applies only to products installed as specified and used as intended for irrigation purposes. Hunter's warranty shall be limited to defects in materials and workmanship during the warranty period, and shall not extend to situations in which the product was subjected to improper design, installation, operation, maintenance, application, abuse, improper electrical current, grounding, service other than by Hunter authorised agents, operating conditions other than that for which it was designed, or in systems using water containing corrosive chemicals, electrolytes, sand, dirt, silt, rust, or agents that otherwise attack and degrade plastics. Hunter's warranty does not cover component failures caused by lightning strikes, electrical power surges, or unconditioned power supplies. If products are repurchased, the price to Distributor for such products in effect at the time of return will apply.

Hunter's obligation to repair, replace, or repurchase its products or product components as set forth above is the sole and exclusive warranty extended by Hunter. There are no other warranties, expressed or implied, including warranties of merchantability and warranties of fitness for a particular purpose. Hunter will not be liable to a distributor or to any other party in strict liability, tort, contract, or any other manner for any damages caused or claimed to be caused as a result of any design of or defect in Hunter's products, or for any special, incidental, or consequential damages of any nature.

Where applicable, Hunter's statement of warranty complies with local directives.

If you have any questions concerning the warranty or its application, please email support@hunterindustries.com.

ASAE CERTIFICATION STATEMENT

Hunter Industries Incorporated certifies that pressure, flow rate, and radius data for these products were determined and listed in accordance with ASAE Standard S398.1, Procedure for Sprinkler Testing and Performance Reporting, and are representative of performance of production sprinklers at the time of publication. Actual product performance may differ from the published specifications due to normal manufacturing variations and sample selection. All other specifications are solely the recommendation of Hunter Industries Incorporated.



Helping our customers succeed is what drives us. While our passion for innovation and engineering is built into everything we do, it is our commitment to exceptional support that we hope will keep you in the Hunter family of customers for years to come.

Gregory R. Hunter, CEO of Hunter Industries

Gene Smith, President, Landscape Irrigation and Outdoor Lighting

Website hunterindustries.com | **Customer Support** +1-760-752-6037 | **Technical Service** +1-760-591-7383

USA HEADQUARTERS

1940 Diamond Street
San Marcos, CA 92078 USA
TEL: +1-760-744-5240

MEXICO

ISO 9001:2015 Certified
Calle Nordika #8615
Colonia la Joya
Parque Industrial Nordika
Tijuana, B.C., Mexico CP 22640
TEL: +011-52-664-903-1382

EUROPE

Avenida Diagonal 523, 5o-2a
Edificio Atalaya
08029 Barcelona, Spain
TEL: +34 934-948-881

AUSTRALIA

Suite 7, 202 Ferntree Gully Road
Notting Hill, VIC 3168, Australia
TEL: +61 3 9562-9918

MIDDLE EAST

P.O. Box 2370
Amman, 11941, Jordan
TEL: +962 6-5152882
FAX: +962 6-5152992

CHINA

B1618, Huibin Plaza
No. 8, Beichen Dong Street
Beijing 100101, China
TEL/FAX: +86 10-84975146

